

CAVAN COUNTY COUNCIL

Cavan Regional Sports Campus

Traffic Statement

March 2024

HoyDorman

Document Information and History

Project: Cavan Regional Sports Campus
Client: McAdam Design
Hoy Dorman Job Number: 2023001
Project Director: Martin Hoy
Author: Martin Hoy, BEng 'Hons', CEng, FIEI, FICE, FCIHT

Version	Date	Description / Revision	Created by:	Verified by:	Approved by:
0	06/03/2024	Traffic Statement	MH	KD	MH

Table of Contents

1	Non-Technical Summary	6
	Area of Potential Influence.....	6
	Methodology.....	6
	Traffic and Pedestrian Generation.....	7
	Peak Hours & Parking Profile.....	7
	Car Sharing and Direction of Vehicle Approach.....	7
	Area of Influence (Road Network).....	7
	Park Lane (Which Includes GAA Breffni Park Traffic).....	7
	The Royal School.....	8
	GAA Breffni Park.....	8
	Guidance & Policy.....	8
	Consultation.....	8
2	Existing Conditions	9
	Junctions Considered.....	9
	Committed Transport Proposals & Surrounding Proposed Development.....	11
	GAA Breffni Park.....	12
	The Royal School.....	13
3	Proposed Development	14
	GAA – Breffni Park.....	14
	Royal School Bus & Private Vehicle Drop Off.....	14
	Park Lane Alternative Route.....	15
	Development Access / Egres.....	15
	Development Access Road.....	15
	Dublin Road Pedestrian Crossing Points.....	15
4	Person Trip Generation	15
	Pedestrian Profile.....	15
5	Construction - Traffic & Impacts	16
	Impact Projection Methodology.....	16
	Construction Traffic Generation & Impacts.....	17
	Construction Hours.....	18
6	Traffic Forecasting	18
	Assessment Years and Growth Rates.....	18
	Traffic Generation.....	18
7	Modal Split	20
8	Trip Distribution	20
	Catchment Area.....	20
	Transfer Trips.....	20
	Pass-by Trips.....	20
	Combined Trips.....	21
9	Trip Assignment	21
	The Proposed Development.....	21
	The Royal School & Park Lane (Breffni Park Traffic).....	22
10	Assessment / Modelling Results & Analysis	23

Traffic Modelling	23
11 Road Impact.....	24
Peak Hours.....	24
Flow Diagrams.....	25
Junctions Modelled as Part of this Study.....	25
Sensitivity Testing.....	25
12 Cumulative Impacts.....	25
Delivery Vehicles & Committed Development	25
13 Road Safety	26
14 Environmental Impact.....	26
15 Internal Layout.....	26
Circulation and Pedestrian Routes.....	26
Development Road	26
Right Turn Lane	26
Visibility and Road Widths	26
Traffic Management.....	26
Speed Control Measures	26
Park lane access	26
16 Parking.....	27
Development Parking profile	27
Breffni Park Parking.....	27
17 Public Transport.....	28
Regional Connections.....	30
Conclusion.....	30
18 Pedestrians / Cyclists	30
ISO Distance Mapping.....	30
Access Points	32
Internal Layout.....	33
19 Accessibility and Integration.....	34
Accessibility	34
Integration.....	34
Local Severance	34
20 Access for People with Disabilities.....	34
Legal Framework and Policy Context.....	34
21 Mitigation & Conclusion	35
Right Turn Lane	35
Park Lane Improvements.....	35
School Bus Re-routing	35
Dual Egress Lanes	35
Pedestrian Accesses	35
Construction Mitigation	36
Conclusion.....	36
Appendix A – Person Trip Generation.....	37

Appendix B – Traffic Generation

Appendix C – Junctions 10 Modelling

Appendix D – Flow Diagrams

List of Figures

Figure 1: Proposed Project Location Plan	6
Figure 2: Initial Junction Surveyed	10
Figure 3: Dublin Road AADT Profile.....	11
Figure 4: Breffni Park Main Elements.....	12
Figure 5: Royal School Access and Lane.....	13
Figure 6: Pedestrian Profile Across Thursday and Saturday	16
Figure 7: Pedestrian Profile Thursday	16
Figure 8: Pedestrian Profile Saturday.....	16
Figure 9: Vehicular Profiles for a Thursday and Saturday	19
Figure 10: High Level Direction of Travel	21
Figure 11: Areas of Population Cavan.....	22
Figure 12: Modelling Results (Development + Royal School + Park Lane Traffic)	23
Figure 13: Modelling Results (Development Only)	24
Figure 14: Parking Profile.....	27
Figure 15: Local Cavan Area Bus Routes	28
Figure 16: C2 Bus Timetables.....	29
Figure 17: 2km ISO Walking Distance.....	31
Figure 18: 5km ISO Distance Cycling.....	32
Figure 19: Proposed Access Points	33

1 Non-Technical Summary

Hoy Dorman (HD) have been commissioned by McAdam Design to prepare a Traffic Statement (TS) for the proposed Cavan Regional Sports Campus as part of the Environmental Impact Assessment Report (EIAR) and planning application for the proposed scheme. This report has been laid out in line with TII Guidelines.

Area of Potential Influence

The study area has been defined within the wider planning application package and EIAR.

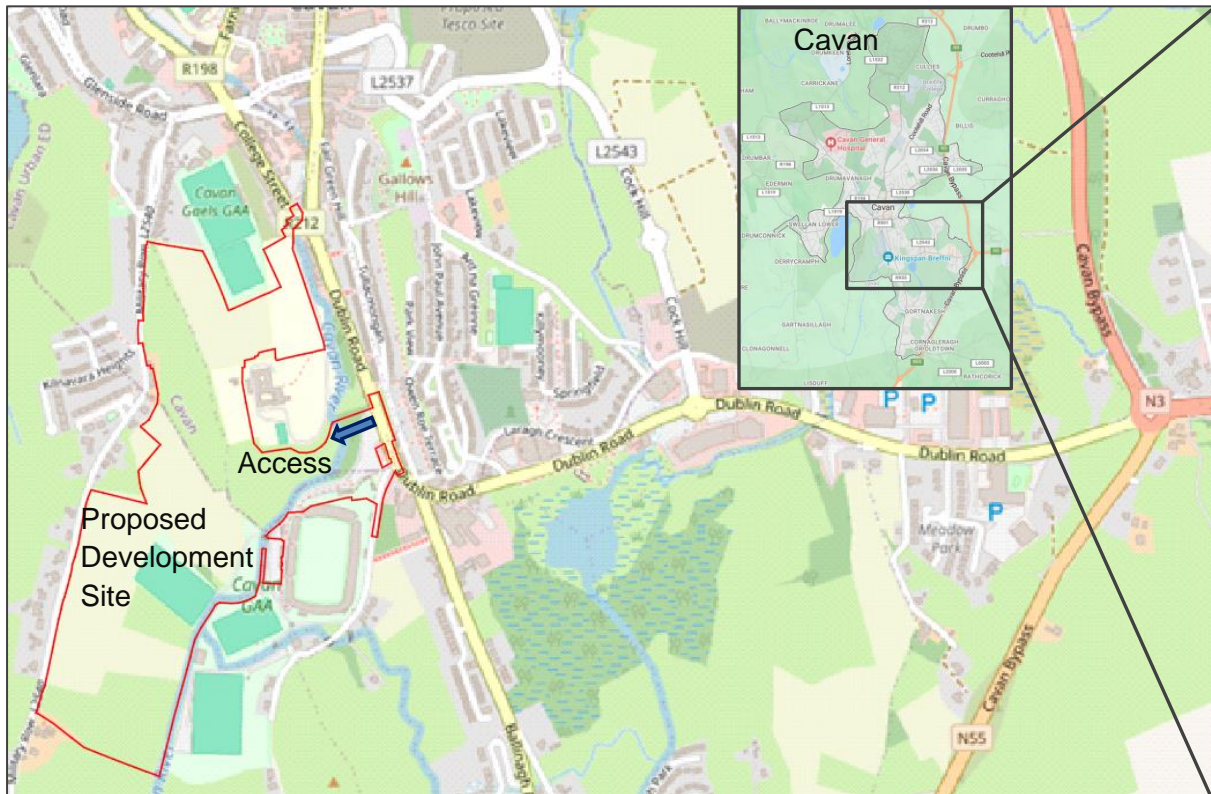

Figure 1: Proposed Project Location Plan

Methodology

While adopting the respective guidelines set out below, the assessment methodology relies on the following principles.

- Expected use of the proposed Cavan Regional Sports Campus – The PEACE Link in Clones, Co Monaghan is a similar facility which has been surveyed on both weekdays and weekends to ascertain likely generated use to the proposed development.
- Baseline traffic surveys - Baseline traffic surveying desktop study with existing traffic data available combined with additional traffic surveys specific to the proposed development.

In establishing the impact proposed development traffic will have on the existing baseline traffic the following method has been adopted.

- Existing Road Network - Comparing the baseline traffic presented to the additional traffic generated during construction and operation for normal use.

- No discount for existing trips associated with the Royal School and Park Lane to ensure robust assessment.

Traffic and Pedestrian Generation

Pedestrian, cycling and vehicular trips have been derived by means of surveying and profiling the PEACE Link sports facility in Clones. However, as the PEACE Link is slightly smaller than the proposed development a factor of 1.5 for vehicle trips has been applied to ensure a robust assessment. Pedestrian movements were multiplied by 2 due to the proposal being closer to areas of population than the PEACE Link therefore more likely to generate pedestrian trips.

A Thursday and a Saturday were surveyed and have been profiled due to the nature of the development having different demands depending on a weekday or weekend.

Peak Hours & Parking Profile

Peak hours for the surrounding road network were 08:15 - 09:15 and 17:00 – 18:00. However, the peak hours for the proposed development as a sports grounds are outside the road network peak hours. Profiling of the PEACE Link sports facility indicates peak hours of 19:30 – 20:30 midweek and 12:30 – 13:30 on a weekend. This is in keeping with a sports complex of this nature.

A projection of the number of vehicles and the estimated profile for a typical day have been assessed within this study. It is proposed to provide 160 spaces for the proposed development.

The modelling results indicate the junction has sufficient residual capacity to accommodate the proposed development + Royal School + Park Lane (Breffni Park) traffic.

Car Sharing and Direction of Vehicle Approach.

Observations from The PEACE Link survey would suggest 2 persons per vehicle, however the use of 1.3 persons per vehicle is considered more onerous and therefore has been assumed for the purpose of this assessment.

Direction of travel has been determined from a gravity model which indicated a 70% / 30% split with the majority of traffic travelling from the north. No discounts for existing or pass by traffic has been applied as a form of sensitivity.

Area of Influence (Road Network)

The main junctions within the area of influence have been described in Chapter 4. Given the peak hour for the proposed sportsground development fall outside the road network peak hour the area of influence is primarily on the Dublin Road.

Park Lane (Which Includes GAA Breffni Park Traffic)

It is proposed to stop up Park Lane at its junction with Dublin Road, to then merge Park Lane with the proposed new access into the proposed development. Park Lane traffic has been included within the new access traffic but is not new to the existing road network.

This has significant benefits for Park Lane in terms of safety improvements regarding sightlines, approach gradients to the Dublin Road etc. It is proposed to maintain a footway from the existing Park Lane to facilitate Breffni Park.

The Royal School

As part of this application the adjacent Royal School will utilise the proposed development carpark during the schools AM and PM peak hours for private vehicles and buses to drop off / collect students, this will remove the need for these vehicles to stop on the Dublin Road and therefore assist with the flow of traffic within the local area. The Royal School traffic has been included within the new access traffic but is not new to the existing road network.

GAA Breffni Park

The proposed scheme will provide Breffni Park with four additional pitches and associated parking. This is considered betterment of the facilities; the pitches will facilitate ladies GAA and removing the use of Breffni Park itself as a training pitch. There is not expected to be any additional traffic associated with the proposed pitches, rather betterment of facilities.

Construction Phase

The construction phase of the proposed development has been assessed within this study and is expected to have a low impact on the surrounding road network during the two phased of construction.

Guidance & Policy

A review of each of these documents has been undertaken. Comments have been provided where appropriate on their relevant application to the proposed development. The guidance documents that have been used within this chapter include:

- Traffic and Transport Assessment Guidelines, National Roads Authority, May 2014.
- Design Manual for Urban Roads and Streets (DMURS), Department of Transport, Tourism and Sport (DTTAS), March 2013.
- Draft Guidelines on the Information to be Contained in Environmental Impact Assessment Reports, Environmental Protection Agency (EPA), August 2017.
- Pedestrian Crossing Specification and Guidance, NRA, April 2011.
- DN-GEO-03060: Geometric Design of Junctions, Transport Infrastructure Ireland (TII), June 2017.
- DN-GEO-03031: Rural Road Link Design, TII, June 2017.
- Shared Spaces Capital Development – 2nd Call Application, Economic Appraisal, April 2019 (Draft Final Report).

Predicted traffic generation figures for the construction and operational phases of the proposed development are based on information provided by Cavan County Council.

Consultation

Various statutory consultees have been considered as part of this application regarding environmental aspects of the application. Further details can be obtained within the main body of the EIAR.

2 Existing Conditions

The town's traffic dynamics have been significantly influenced by its strategic location on major routes like the N3 and N55, as well as by local factors such as population and commercial growth. Key points to inform the existing conditions include:

1. **Strategic Location:** Cavan Town is on the N3 route linking Dublin to Enniskillen, and the N55 linking Athlone to Cavan. This makes it a critical junction for regional traffic.
2. **Growth in Traffic Volumes:** Over the past two decades, there's been a notable increase in both through traffic (on the N3 and N55) and internal traffic due to rising population and economic activities.
3. **N3 and N55 Bypasses:** The construction of these bypasses in 1999 has helped alleviate some traffic pressure from the town's streets, though managing the benefits of these routes remains crucial.
4. **High-Traffic Routes and Junctions:** The Dublin Road (Old N3) remains a highly trafficked route, especially during peak hours. The intersection of Dublin Road and Ballinagh Road, a priority junction, has historically seen significant congestion, although the N55 bypass has reduced traffic on the Ballinagh Road.
5. **Other Major Roads and Junctions:** Swellan Road and Railway Road are key radial routes to the west, with a critical roundabout junction at Railway Road, College Road, and Farnham Street. Cathedral Road and Cootehill Road in the north are less congested distributor routes.
6. **Town Centre Traffic Management:** The town centre, built around Main Street and Farnham Street, operates a one-way system due to high traffic volumes and narrow streets. This system primarily involves Church Street/Main Street being one-way southward leading to Connolly Street, with most linking streets being one-way and others carrying two-way traffic.

Overall, the traffic situation in Cavan Town reflects a balance between accommodating through traffic on major national routes and managing internal traffic flows within the town, especially in the context of urban growth and development. The strategic implementation of bypasses and one-way systems has been key in mitigating congestion and improving traffic flow, but ongoing management and possibly further infrastructural development may be necessary to address future traffic demands.

Junctions Considered

The locations below have been selected as representing road link network within the initial area of influence for the scheme as assessment nodes for baseline and development traffic.

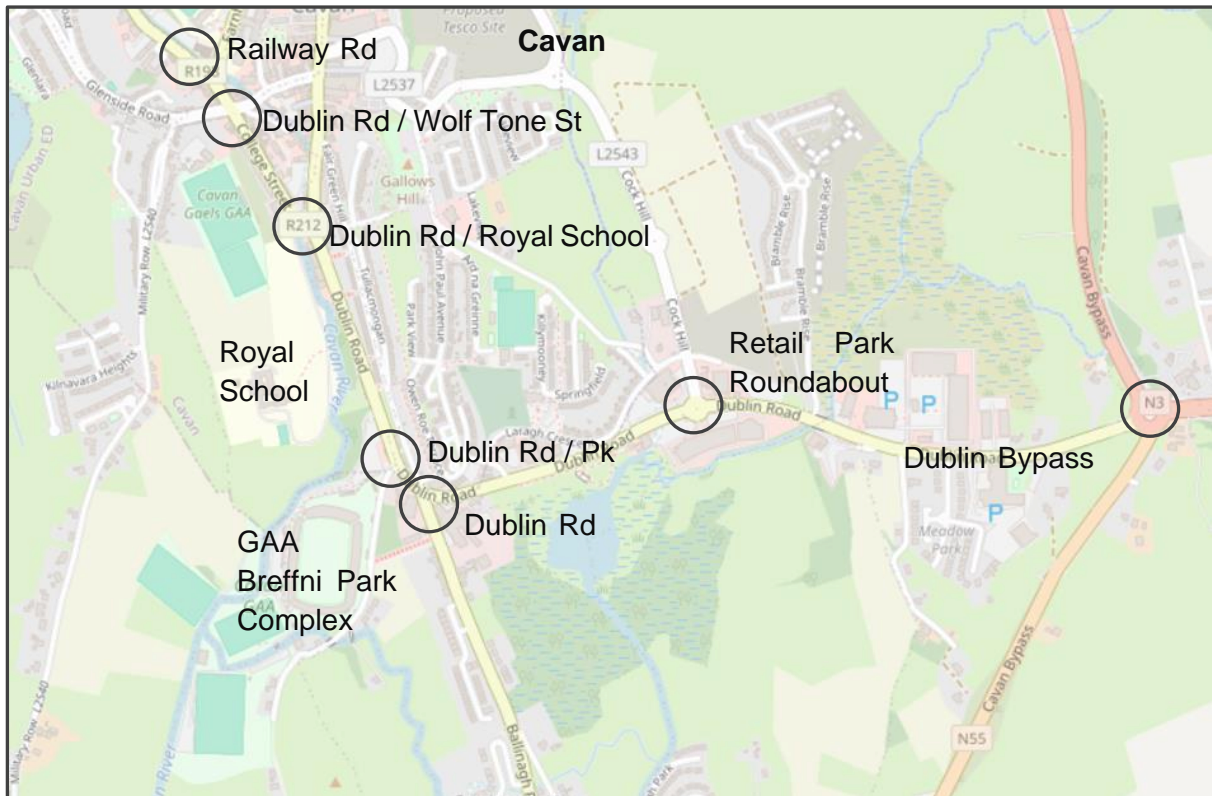

Figure 2: Initial Junction Surveyed

1. Dublin Road Bypass Roundabout: This 4-arm roundabout has dual entry and single lane exit on all arms. The Dublin Road benefits from footways on both side of the carriageway.
2. Retail Park Roundabout: This 4-arm roundabout provides access to the retail park. There are consistent footways and street lighting within the area. The roundabout has single lane entry and exit on all arms.
3. Dublin Road / Ballinagh Road crossroads: The Ballinagh Road benefits from footways and streetlighting. There are no turning lanes at the junction of Dublin Road. The Dublin Road benefits from a right turning lane onto Ballinagh Road. Owen Roe Terrace is a narrow minor two-way road with no white lining along its entirety.
4. Dublin Road / Park Lane: Park Lane priority T junction benefits from right and left-hand turning lanes. The Dublin Road benefits from footways, dropped kerbs and street lighting within the area. There is no right turning lane from the Dublin Road. The sightlines from Park Lane are substandard with the addition of a steep approach. Traffic that utilises Park Lane is mainly associated with Breffni Park and nine residential dwellings.
5. Royal School Access – The entrance / exit to the school is served by a right turning lane with a yellow box hatched on the opposing lane. There are consistent footways, dropped kerbs and street lighting in the surrounding area.

6. Dublin Road Crossroads / Wolfe Tone Street: From Wolfe Tone Street is a two-way road, at the crossroads the only permitted movement is left onto the Dublin Road. Bridge street opposite is a narrow one-way street from which you can turn in all directions. Movements from the Dublin Road are signalled, there are no filter lanes in any direction.
7. Railway Road Roundabout: This three-arm roundabout has dual entry lanes and single exit lanes on each arm. Each arm has consistent footways with dropped kerbs and pedestrian islands.

The AADT for the Dublin Road is illustrated below in Figure 3 below both for a weekday and weekend.

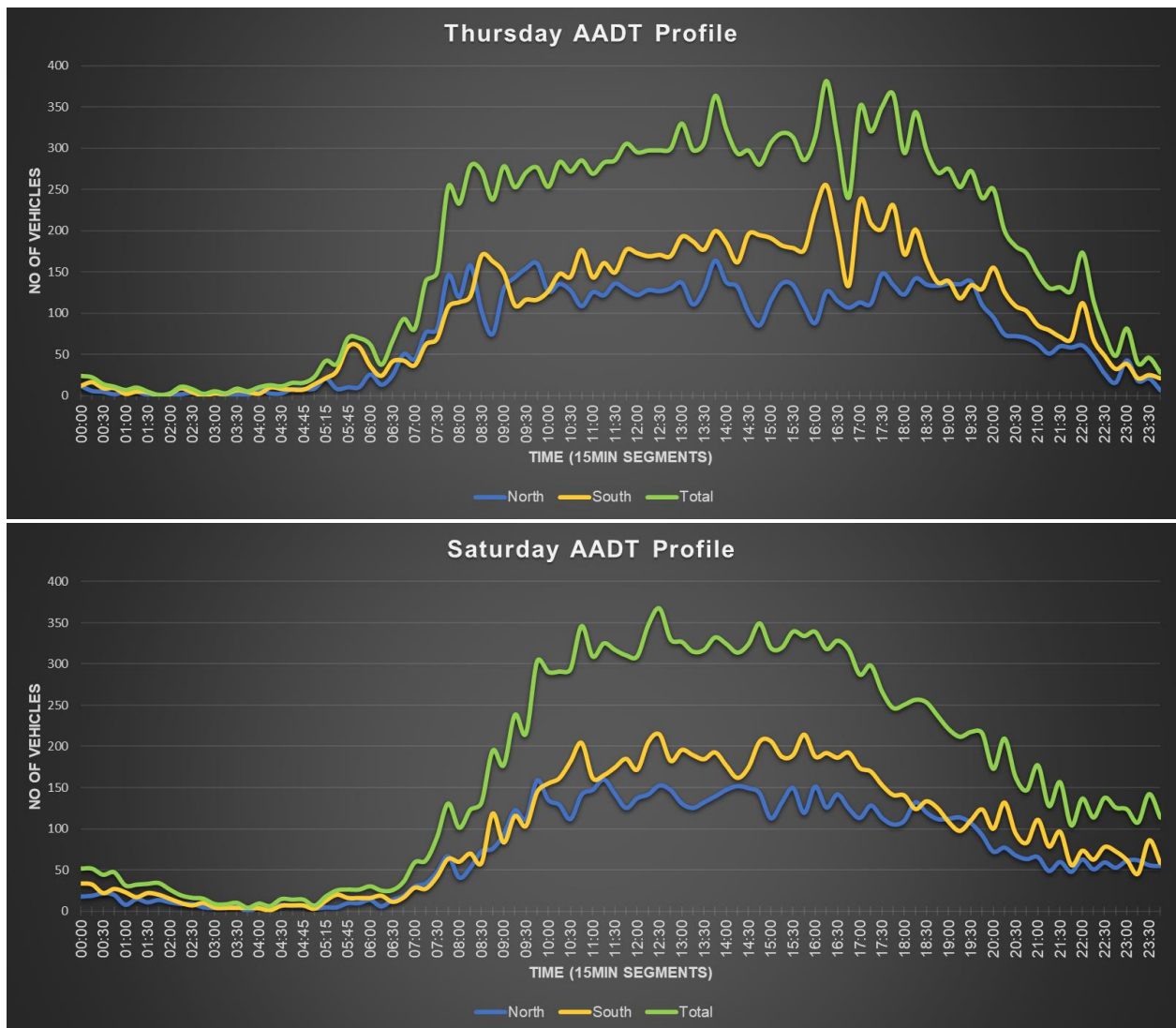

Figure 3: Dublin Road AADT Profile

Committed Transport Proposals & Surrounding Proposed Development

There are no major committed transport or development proposals within the surrounding area that this study has been made aware of.

GAA Breffni Park

Breffni Park is a prominent sports and recreational facility with access from Park Lane, as stated above Park Lane only serves Breffni Park and nine residential dwellings. The overall site covers 26 acres and serves as a pivotal hub for various sporting events and community activities, facilities include:

- GAA Stadium
- Training Pitches (recent additional pitch across the river)
- Community Centre
- Playground
- Walking and Jogging Trails
- Café



Figure 4: Breffni Park Main Elements

The internal roadways and carparks are constructed from a compacted unbound material with limited formalised spaces for private vehicles. Prior to large matches a traffic management plan is published on <https://cavangaa.ie> as well as local papers and ticket sites to advise on direction of travel and available parking within the surrounding area.

The Royal School

The Royal School access is adjacent to the proposed site. The modal split to the school is circa 6% cycle, 10% walk, 45% bus and 39% private vehicle. The school access from the Dublin Road is narrow, in the AM peak parents dropping off students drive into the school grounds however, there is not enough room at the access for two cars to pass therefore causing congestion onto the Dublin Road. The school buses have no access to the site and stop on the road outside of the school gates to drop off and collect students, this causes congestion in the already busy morning peak.

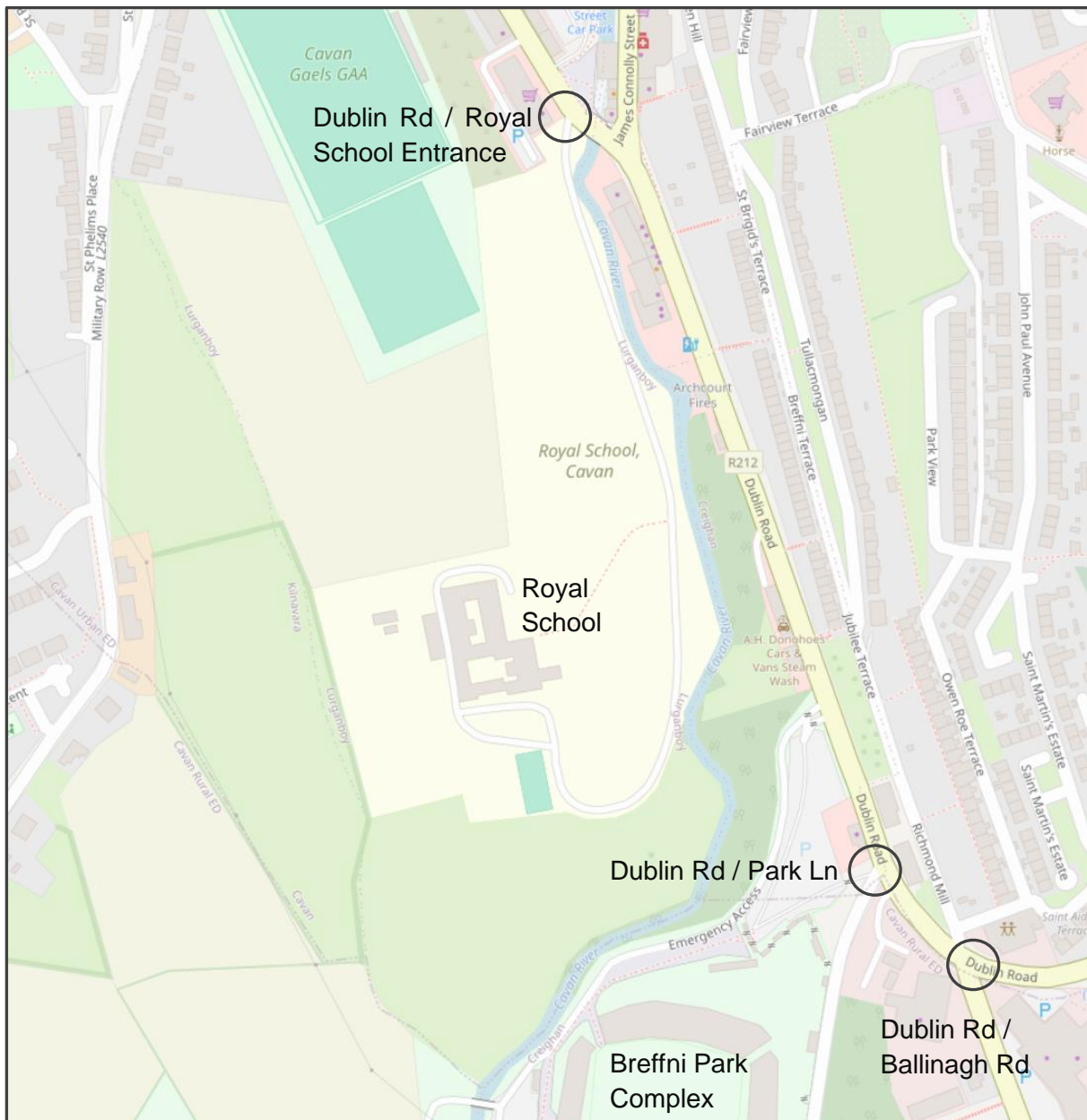

Figure 5: Royal School Access and Lane

3 Proposed Development

The proposed development involves the provision of Cavan Regional Sports Campus, consisting of the following components:

- Indoor sports complex to include sports halls with spectator seating, fitness studios, changing facilities, reception, café and ancillary accommodation.
- 7 no. outdoor sports pitches.
- Covered sports arena with playing pitch, spectator seating and other ancillary accommodation.
- Ancillary sporting facilities include 8 lane athletics track and cricket practice nets.
- New vehicular access / junction and closure of Park Lane/Dublin vehicular junction, relocation of existing Breffni Park turnstiles to facilitate reconfiguration of Park Lane, bridge structure, internal roads, cycle/pedestrian paths, associated car/bus/cycle parking, electric charge points and streetlighting.
- Pedestrian access points of Kilnavara Lane and Dublin Road.
- Hard and soft landscaping including acoustic fencing, wildlife habitat area/corridors, artificial badger-sett, walking trails and other ancillary works such as spectator stands, retaining walls, fencing and ball stop fencing, team shelters, toilet block, floodlighting, signage, drainage infrastructure including attenuation tanks, SuDs and culverting of a minor watercourse, storage space, ESB Substation, ancillary accommodation and all associated site works to accommodate the development.

GAA – Breffni Park

- The proposed additional pitches (four of the proposed 7) are a betterment of the existing facilities at Breffni Park, these pitches will facilitate female GAA access to training pitches they will also enable the main Kingspan Stadium to be reserved for matches rather than being used as training pitch.
- All parking within the site will be upgraded and formalised, the carpark associated with Breffni Park will be gated. No additional GAA traffic will be generated to the site post redevelopment as this is a betterment of facilities only.
- The lower carpark will be extended to accommodate circa 150 vehicles, the road leading to the carpark will be gated and used for parking associated with Breffni Park Carpark. All internal roadways and carpark surfaces will be upgraded. Please see drawings for more information.

Royal School Bus & Private Vehicle Drop Off

- The Royal School is going to utilise the proposed upper carpark in the AM and PM peaks for parents to drop off and collect students, there will be no parking within the site associated with the school throughout the remainder of the day.
- All buses associated with school pick up and drop off will utilise the upper carpark to allow students to disembark and embark this will help alleviate the congestion associated with the buses stopping on the road outside of the school gates.
- A new pedestrian access will be created from the carpark directly into the school, please see drawing package for more information.

Park Lane Alternative Route

It is proposed to stop up Park Lane at its junction with Dublin Road, to then merge Park Lane with the proposed new access into the proposed development. This has significant benefits for Park Lane in terms of safety improvements regarding sightlines, approach gradients to the Dublin Road etc. It is proposed to maintain a footway from the existing Park Lane to facilitate Breffni Park.

Development Access / Egres

The proposed development will be accessed from the Dublin Road via a right turn lane. The egress will have dual exit lanes to facilitate left and right turning movements.

Development Access Road

The proposed development access road will double up as emergency access / egress for Breffni Park. The access road is proposed to be adopted as far as the carpark; Cavan County Council will maintain anything past the adoption line.

Dublin Road Pedestrian Crossing Points

A pedestrian crossing island is proposed across the development access. Two further Zebra crossings with Belisha beacons will be included within the internal access road to facilitate pedestrian movements within the site. All crossing points will benefit from tactile paving.

4 Person Trip Generation

Pedestrian, cycling and vehicular trips have been derived by means of surveying and profiling the PEACE Link an existing sports facility in Monaghan. The PEACE Link facilities include: a 400m tartan running track with field facilities, an in-field soccer sized grass pitch, a 3G multi-purpose playing pitch (of full GAA size and to a spec that will accommodate GAA, Rugby and Soccer), outdoor multi use games area, a sports centre with accommodation for indoor sports such as bowling, karate, archery, badminton, soccer, basketball, boccia and many more; changing facilities, a state of the art gym and other functional complementary facilities.

The PEACE Link is a slightly smaller development than that which is being proposed therefore, to ensure a robust assessment all associated vehicle movements were multiplied by 1.5, this is somewhat of an overestimation to ensure a robust assessment. Pedestrian movements were multiplied by 2 due to the proposed sports facility being constructed closer to areas of population than the PEACE Link.

A Thursday and a Saturday were surveyed and have been profiled due to the nature of the development having different demands depending on a weekday or weekend.

Pedestrian Profile

(PEACE Link)

Figure 6 depicts an overall pedestrian profile for Thursday (orange) and Saturday (blue).

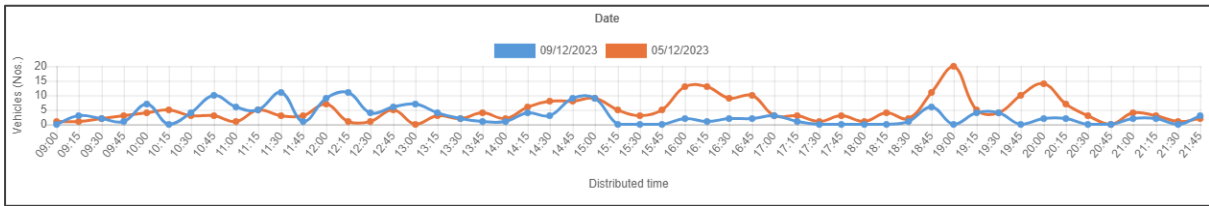

Figure 6: Pedestrian Profile Across Thursday and Saturday

Figures 7 and 8 depict both pedestrian (blue) and cyclists (orange).

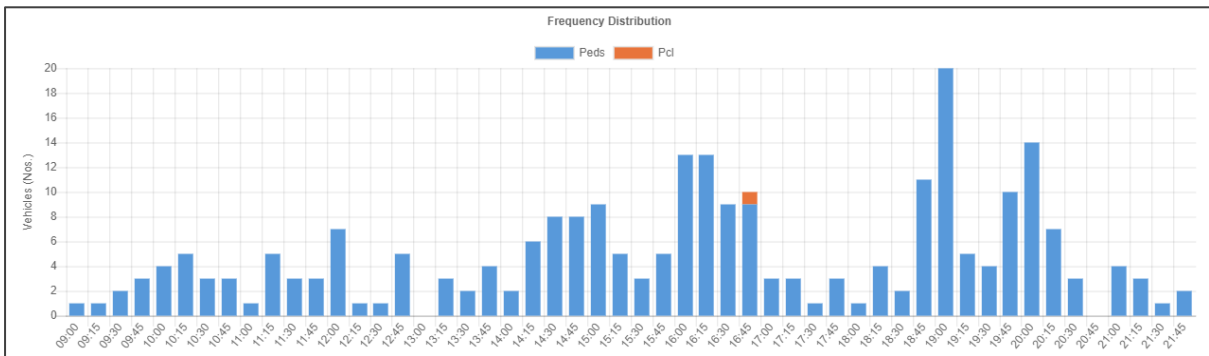

Figure 7: Pedestrian Profile Thursday

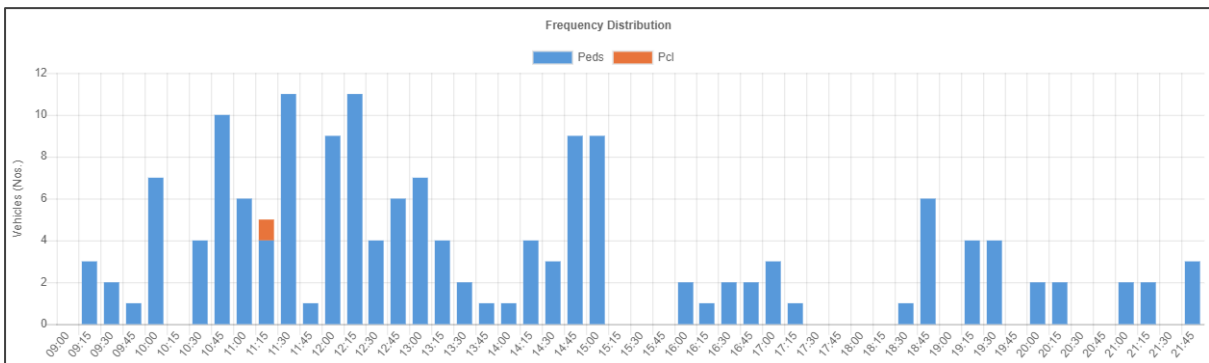

Figure 8: Pedestrian Profile Saturday

In relation to the proposed development a factor of 2 was applied to PEACE Link pedestrian survey to estimate the number and profile of pedestrians using the proposed site. Further details are contained in Appendix A. It is estimated some 120 pedestrians will use the complex on an average weekday with some 60 pedestrians on a Saturday.

5 Construction - Traffic & Impacts

Impact Projection Methodology

The project will involve the use of heavy construction vehicles and machinery. Traffic management arrangements will be in place including a Traffic Management Plan to consider both onsite and offsite traffic related control measures. The Traffic Management plan will clearly outline the proposals for minimising the impact of his site traffic on the public, the project stakeholders and local property owners.

Cavan County Council will ensure that any traffic management systems in place on the site access roads are included in the traffic management and safety plan particularly in relation to traffic movements at the entrance to the site. The plan will also comply with Cavan County Council and An Garda Síochána requirements. Temporary Road Signage will be put in place as per current guidelines.

All works impacting on public roads surrounding the site should be carried out in compliance with all relevant statutory procedures.

A programme for the construction phases is set out below, green shading indicates construction periods.

Phase	2025				2026				2027				2028				2029			
	Q1	Q2	Q3	Q4	Q1	Q2	Q3	Q4	Q1	Q2	Q3	Q4	Q1	Q2	Q3	Q4	Q1	Q2	Q3	Q4
1																				
2																				

Table 1: Construction Phase Programme

Table 2 sets out the expected construction vehicle traffic generated by construction on an average day. The number of HGV movement has been informed by the CMP and construction period from the scheme programme. The average LGV and staff trips have been assumed. No discounts of vehicles have been applied to ensure a robust assessment.

Phase	Construction Period		Average HGV's		Average 'Other Vehicles'		Total Daily Construction Traffic Trips	
	Months	Weeks	Week	Day	LGV	Staff	One Way	Two Way
1	19	76	186	34	20	12	66	132
2	28	112	121	22	20	12	54	108

Table 2: Two Way Movements Construction Phase

Construction Traffic Generation & Impacts

The construction is being phased Table 3 sets out the comparison of baseline AADT and the construction development traffic across the two phases.

Phase	Construction Period		Average HGV's		Average 'Other Vehicles'		Total Construction Traffic Trips		Impact on Dublin Road		
	Months	Weeks	Week	Day	LGV	Staff	One Way	Two Way	Dublin Road AADT (Base)	Base + Construction	Percentage Impact
1	19	76	186	34	20	12	66	132	17,392.40	17,524.04	0.75%
2	28	112	121	22	20	12	54	108	17,392.40	17,500.40	0.62%

Table 3: Construction Phase Expected Traffic Generation

When the construction traffic is added to the factored 2027 Dublin Road AADT baseline traffic, the impact for Phases 1 and 2 are 0.75% and 0.62% respectively.

The construction impact will be temporary during the construction phases.

Construction Hours

The hours of construction activity will be limited to avoid unsociable hours. Construction works shall be restricted to between 08:00hrs and 18:00hrs on weekdays and between 08:00hrs and 13:00hrs on Saturdays. There will be no works carried out on Sundays or Bank Holidays.

In the delivery of large precast concrete structures (TBC – potential box culvert option or bridge structures), it may be necessary to work outside of these hours. Any such out of hours working will be agreed in advance with the Local Authority and will be part of a specific Traffic Management Plan (TMP).

Emergency works for safety and/or environmental protection may also be required to extend outside of normal hours in the event of an incident at the site.

6 Traffic Forecasting

Assessment Years and Growth Rates

In line with TII Project Appraisal Guidelines for National Roads Unit 5.3 – Travel Demand Projections (October 2016), design years of 2032 and 2042 have been used in this assessment to represent a 5-year and 15-year design horizon for studying any identified impacts of the development on the existing surrounding roads network.

- 2023 - Base Year (Survey Year).
- 2027 - Opening Year (With / Without Development).
- 2032 - Opening Year + 5 Year Forecast (With / Without Development).
- 2042 - Opening Year + 15 Year Forecast (With / Without Development).

Low growth rates were applied to the base network traffic flows to allow for a reflective analysis of the future year scenarios. This will account for general traffic growth within the area, which will increase the amount of traffic on the base network.

National Roads Authority Growth Rates were obtained from the Project Appraisal Guidelines – Unit 5.3 ‘Traffic Forecasting’ <http://www.nra.ie/policy-publications/>.

	From Year	To Year	Growth Rate	Factor %	Notes
G1	2023	2027	0.049	1.049	Opening Year
G2	2023	2032	0.083	1.083	+ 5 Years
G3	2023	2042	0.1044	1.1044	+ 15 Years

Table 4: Growth Rates

Traffic Generation

Traffic generation has been generated using a survey of the PEACE Link development during a Thursday and a Saturday then applying a factor of 1.5 given the proposed development is larger than the PEACE Link. Using the latter a daily expected profile of generated traffic was generated. It is expected some 378vehicles will be generated on a typical weekday and 225vehicles on a Saturday. Details of the proposed development flows are contained in Appendix B

As expected in relation to a sporting development the peak hours for the proposed development fall outside the surrounding road network.

Figure 9 below provides a profile of the expected vehicles arriving at the proposed development.

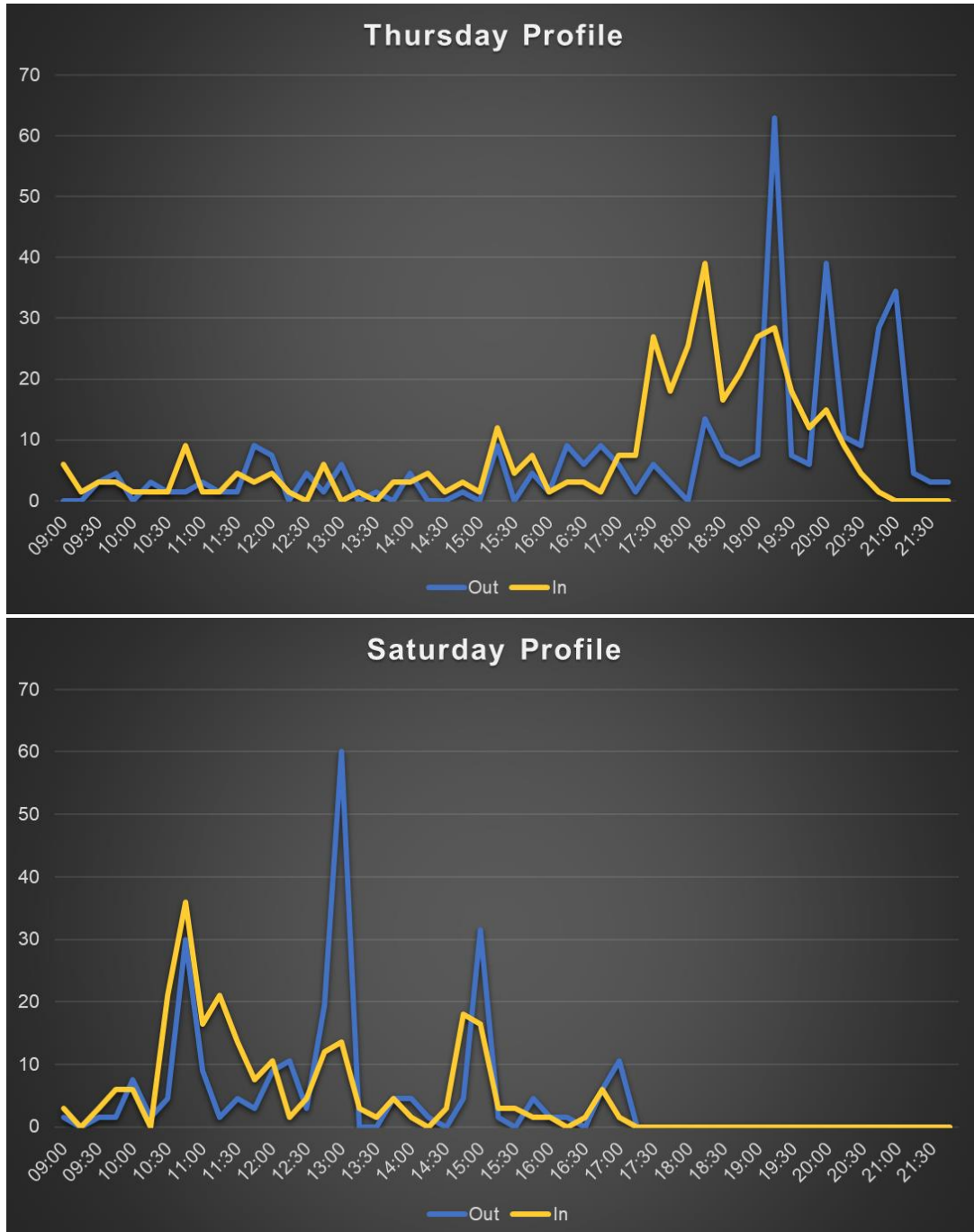

Figure 9: Vehicular Profiles for a Thursday and Saturday

7 Modal Split

The existing PEACE Link development was again used to assist in determining the modal split and volume of persons using the proposed development. As set out above various factors were applied to the daily profile of the PEACE Link site to account for the proposed development scale being larger than the PEACE Link.

Mode	Number of People	Modal Split
Cycle	20	3%
Walk	120	18%
Bus	50	7%
Private Vehicle Driver	380	56%
Private Vehicle Passenger	114	17%
	684	100%

Table 5: Modal Split

TRICS was not considered within this scheme for modal split or trip generation due to no similar surveys being held within the database and the fact PEACE Link is so similar in nature regarding the land use.

8 Trip Distribution

Catchment Area

Due to the nature of the proposal the catchment area for the facility has the potential to be far reaching during events or competitions as demonstrated with the current use of Breffni Park. The use of the gym and pre-existing training grounds are expected to be from those within the local Cavan area.

Transfer Trips

Transfer Trips refer to the journeys that passengers make when they switch from one mode of transportation to another during a single trip. This concept is particularly relevant in the context of public transportation systems.

It is not considered likely that Transfer Trips will be applicable in relation to this proposed development other than the occasional local bus journey.

Pass-by Trips

Pass-by Trips refer to those trips where the primary purpose of the journey is not the destination itself, but the traveller stops enroute to their final destination for a secondary purpose.

It is expected there will be significant pass by trips associated with the proposed development i.e. the use of the gym where users may choose to go on route home. However, to ensure a robust assessment no discount within the traffic modelling has been applied.

It is noted that all trips associated with Breffni Park, Park Lane and the Royal School are already on the existing local and wider road network. However, all of the above have been added into the development flows to test the modelling as a worst-case scenario.

Combined Trips

Combined Trips refer to trips where an individual combines multiple purposes into a single journey, rather than making separate trips for each purpose.

It is expected to be an element of combined trips relating to the proposed development however, no discount has been applied to the traffic modelling in this regard.

9 Trip Assignment

The Proposed Development

The direction of approach to the proposed development has been derived by considering the population census from 2022 for the wider use of the complex. All census towns with over 1000 people within Cavan were included to ascertain a high-level likely percentage approach to Cavan.

Figure 10 represents a broad gravity model based on population size overall 15% from the north and 45% from the south with the remaining 40% living within Cavan town centre itself.

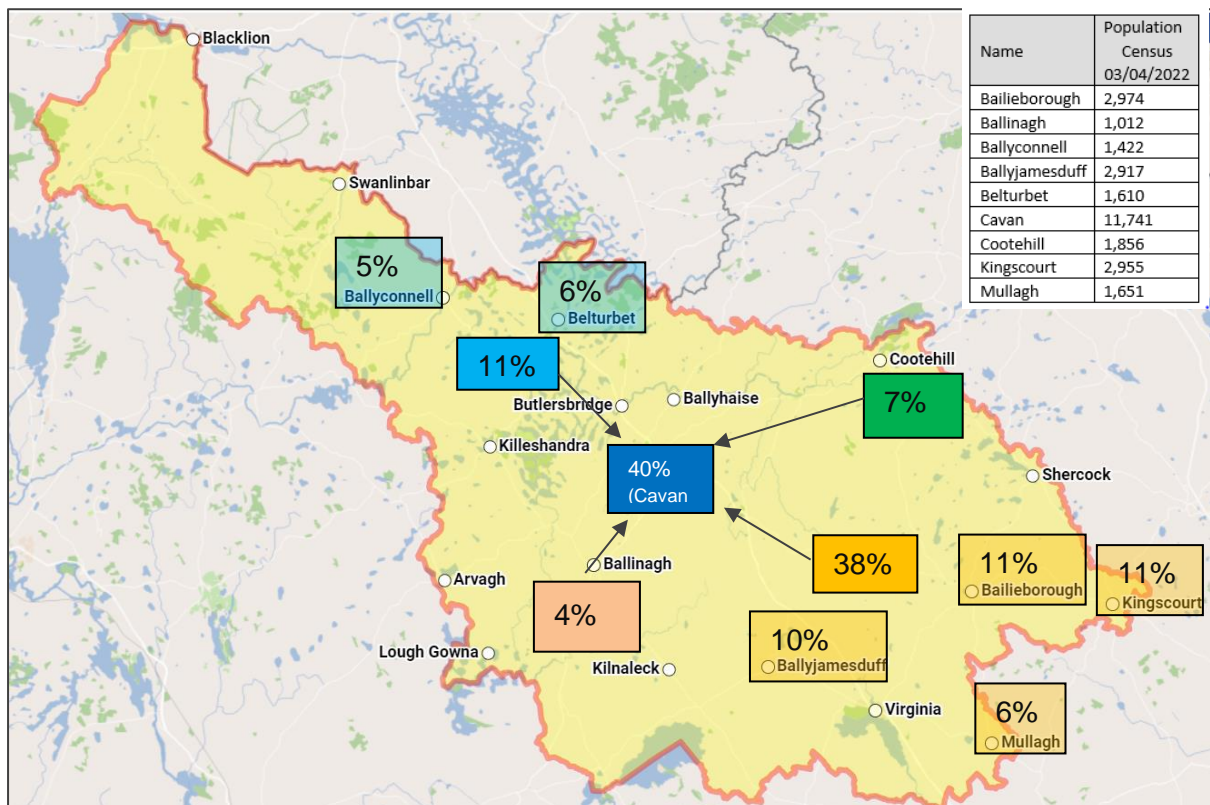

Figure 10: High Level Direction of Travel

Figure 11 shows the percentage split of areas of population within Cavan town centre itself.

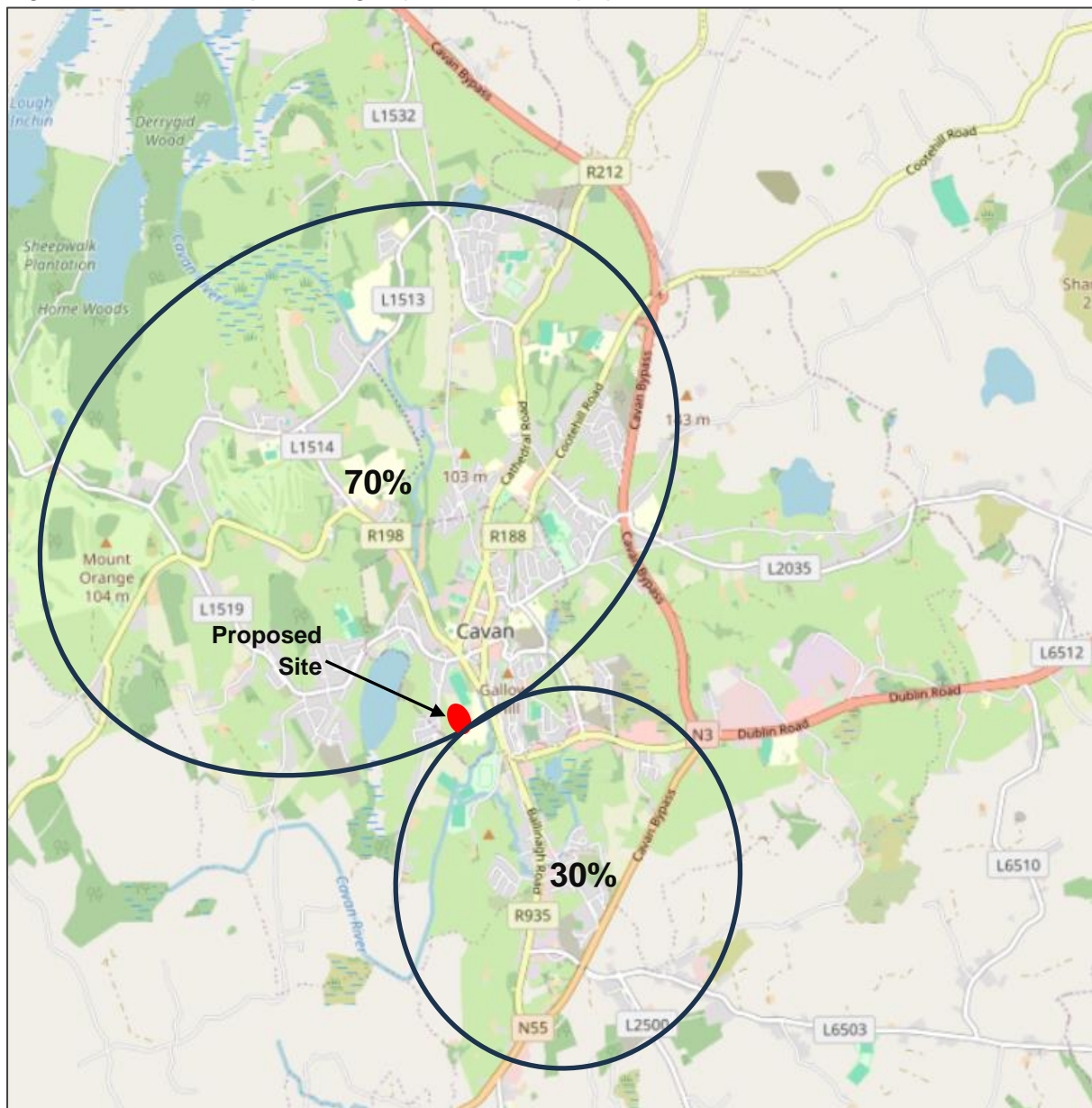

Figure 11: Areas of Population Cavan

Trip assignment to an existing road network has a wide range of variables in determining the origin, destination, shared trips, diverted trips etc. In considering the diagrams above this assessment has assumed 30% will approach the proposed development from the south and 70% from the north. This is reciprocated regarding vehicles leaving the development.

The Royal School & Park Lane (Breffni Park Traffic)

As part of the proposed development, it is proposed private vehicle drop-off and school buses will use the proposed carpark for AM and PM drop-off and pick up. The trip assignment was informed by surveying the existing entrance and applying the same direction of travel as survey results.

The same approach as above has been undertaken for Park Lane traffic as Park Lane will now join the proposed development access. Park Lane serves several dwellings with the majority of traffic serving Breffni Park.

10 Assessment / Modelling Results & Analysis

Traffic Modelling

The traffic impact of the proposed development falls below 5% impact on the Dublin Road during peak hours, therefore the area of influence was focused on the proposed junction with Dublin Road.

While the proposed development + Royal School + Park Lane (including Breffni Park) traffic has a 10% impact on the Dublin Road the traffic for Royal School and Park Lane traffic is already on the local road network. The change for Royal School and Park Lane (Breffni Park) is they access onto Dublin Road via proposed development access.

Given the above and to ensure a robust assessment with sensitivity testing the modelling of the junction includes all traffic combined. Table 6 shows the traffic impact of the proposed development including Royal School and Park Lane (including Breffni Park) traffic.

	AM									PM								
	Set ID	Queue (Veh)	95% Queue (Veh)	Delay (s)	RFC	LOS	Junction Delay (s)	Junction LOS	Network Residual Capacity	Set ID	Queue (Veh)	95% Queue (Veh)	Delay (s)	RFC	LOS	Junction Delay (s)	Junction LOS	Network Residual Capacity
2023																		
Stream B-AC	D1	0.0	~1	0.00	0.00	A	0.00	A	900 %	D10	0.0	~1	0.00	0.00	A	0.00	A	900 %
Stream C-AB		0.0	~1	0.00	0.00	A			□		0.0	~1	0.00	0.00	A			
2027 - Opening Year																		
Stream B-AC	D2	0.0	~1	0.00	0.00	A	0.00	A	900 %	D11	0.0	~1	0.00	0.00	A	0.00	A	900 %
Stream C-AB		0.0	~1	0.00	0.00	A			□		0.0	~1	0.00	0.00	A			
Development Flows																		
Stream B-AC	D3	0.2	0.8	7.89	0.17	A	5.22	A	314 %	D12	0.1	0.5	7.32	0.12	A	4.53	A	435 %
Stream C-AB		0.1	0.5	6.14	0.10	A			[Stream B-AC]		0.1	0.5	6.23	0.11	A			[Stream B-AC]
2027 + Development Flows																		
Stream B-AC	D4	0.3	1.5	12.75	0.25	B	1.27	A	58 %	D13	0.3	1.2	13.81	0.21	B	0.87	A	41 %
Stream C-AB		0.1	0.5	7.57	0.11	A			[Stream B-AC]		0.2	0.5	8.08	0.13	A			[Stream B-AC]
2032 Faactored Base + 5yrs																		
Stream B-AC	D5	0.0	~1	0.00	0.00	A	0.00	A	900 %	D14	0.0	~1	0.00	0.00	A	0.00	A	900 %
Stream C-AB		0.0	~1	0.00	0.00	A			□		0.0	~1	0.00	0.00	A			
2032 Faactored Base + Dev Flows = +5yrs																		
Stream B-AC	D6	0.3	1.0	13.02	0.26	B	1.26	A	55 %	D15	0.3	1.3	14.27	0.22	B	0.87	A	38 %
Stream C-AB		0.1	0.5	7.63	0.12	A			[Stream B-AC]		0.2	0.5	8.15	0.13	A			[Stream B-AC]
2042 Faactored Base + 15yrs																		
Stream B-AC	D7	0.0	~1	0.00	0.00	A	0.00	A	900 %	D16	0.0	~1	0.00	0.00	A	0.00	A	900 %
Stream C-AB		0.0	~1	0.00	0.00	A			□		0.0	~1	0.00	0.00	A			
2042 Faactored Base + 15yrs + Dev Flows																		
Stream B-AC	D8	0.3	1.1	13.20	0.26	B	1.26	A	53 %	D17	0.3	1.3	14.59	0.22	B	0.87	A	36 %
Stream C-AB		0.1	0.5	7.66	0.12	A			[Stream B-AC]		0.2	0.5	8.20	0.13	A			[Stream B-AC]
2042 Faactored Base + 15yrs + Dev Flows x 2																		
Stream B-AC	D9	1.2	5.2	23.09	0.55	C	3.46	A	12 %	D18	0.9	4.4	23.98	0.48	C	2.33	A	10 %
Stream C-AB		0.3	1.4	9.09	0.24	A			[Stream B-AC]		0.4	1.5	10.03	0.28	B			[Stream B-AC]

Figure 12: Modelling Results (Development + Royal School + Park Lane Traffic)

The results of the modelling demonstrate there is sufficient residual capacity at the proposed development access even if the development flows are doubled as a form of sensitivity testing. Details of the modelling are contained in Appendix C

The above represents the worst case with all traffic assessed. However, given that traffic is already on the existing road network modelling was undertaken to demonstrate the impact of the proposed development only. As can be seen the actual impact of the development traffic is significantly less. Details of the modelling are contained in Appendix C

	AM								PM									
	Set ID	Queue (Veh)	95% Queue (Veh)	Delay (s)	RFC	LOS	Junction Delay (s)	Junction LOS	Network Residual Capacity	Set ID	Queue (Veh)	95% Queue (Veh)	Delay (s)	RFC	LOS	Junction Delay (s)	Junction LOS	Network Residual Capacity
2023																		
Stream B-AC	D1	0.0	~1	0.00	0.00	▲	0.00	▲	900 %	D10	0.0	~1	0.00	0.00	▲	0.00	▲	900 %
Stream C-AB		0.0	~1	0.00	0.00	▲		□			0.0	~1	0.00	0.00	▲			□
2027 - Opening Year																		
Stream B-AC	D2	0.0	~1	0.00	0.00	▲	0.00	▲	900 %	D11	0.0	~1	0.00	0.00	▲	0.00	▲	900 %
Stream C-AB		0.0	~1	0.00	0.00	▲		□			0.0	~1	0.00	0.00	▲			□
Development Flows																		
Stream B-AC	D3	0.0	0.5	6.22	0.02	▲	4.61	▲	900 %	D12	0.0	0.5	6.23	0.02	▲	3.44	▲	900 %
Stream C-AB		0.0	0.5	5.57	0.02	▲		□			0.0	0.5	5.59	0.02	▲			□
2027 + Development Flows																		
Stream B-AC	D4	0.0	0.5	8.53	0.03	▲	0.19	▲	139 %	D13	0.0	0.5	9.84	0.04	▲	0.15	▲	79 %
Stream C-AB		0.0	0.5	6.72	0.02	▲		[Stream B-AC]			0.0	0.5	7.04	0.03	▲			[Stream B-AC]
2032 Faactored Base + 5yrs																		
Stream B-AC	D5	0.0	~1	0.00	0.00	▲	0.00	▲	900 %	D14	0.0	~1	0.00	0.00	▲	0.00	▲	900 %
Stream C-AB		0.0	~1	0.00	0.00	▲		□			0.0	~1	0.00	0.00	▲			□
2032 Faactored Base + Dev Flows = +5yrs																		
Stream B-AC	D6	0.0	0.5	8.64	0.03	▲	0.18	▲	132 %	D15	0.0	0.5	10.06	0.04	▲	0.15	▲	74 %
Stream C-AB		0.0	0.5	6.76	0.02	▲		[Stream B-AC]			0.0	0.5	7.10	0.03	▲			[Stream B-AC]
2042 Faactored Base + 15yrs																		
Stream B-AC	D7	0.0	~1	0.00	0.00	▲	0.00	▲	900 %	D16	0.0	~1	0.00	0.00	▲	0.00	▲	900 %
Stream C-AB		0.0	~1	0.00	0.00	▲		□			0.0	~1	0.00	0.00	▲			□
2042 Faactored Base + 15yrs + Dev Flows																		
Stream B-AC	D8	0.0	0.5	8.72	0.03	▲	0.18	▲	127 %	D17	0.0	0.5	10.20	0.04	▲	0.15	▲	71 %
Stream C-AB		0.0	0.5	6.79	0.02	▲		[Stream B-AC]			0.0	0.5	7.13	0.03	▲			[Stream B-AC]
2042 Faactored Base + 15yrs + Dev Flows x 2																		
Stream B-AC	D9	0.1	0.5	9.11	0.07	▲	0.36	▲	114 %	D18	0.1	0.5	10.80	0.08	▲	0.30	▲	63 %
Stream C-AB		0.1	0.5	6.99	0.05	▲		[Stream B-AC]			0.1	0.5	7.39	0.05	▲			[Stream B-AC]

Figure 13: Modelling Results (Development Only)

11 Road Impact

Peak Hours

The development peak hours are illustrated in Section 7 above. The peak hours for the development fall outside the road network peak (08:15 - 09:15 and 17:00 - 18:00) weekdays and weekends). There are no real peak hours for the development in the AM, rather the PM peak 19:00 – 20:00.

Flow Diagrams

Traffic associated with the development is so low and below 5% impact on existing Dublin Road baseline traffic. Flow Diagrams for the initial extended network are contained in Appendix D.

Junctions Modelled as Part of this Study

The proposed junction with the Dublin Road has been modelled including new development flows + Royal School + Park Lane (including Breffni Park) traffic flows. However, two sets of Flow Diagrams have been provided and modelled at Junction 5 (proposed development access). 1) to show the combined existing traffic + existing as set out above, and 2) new traffic on the proposed network associated with the proposed development. It should be noted the latter falls well below the 5% threshold (1-2%) of the existing traffic at Junction 5 (proposed access / Dublin Road). Therefore, no additional modelling at other junctions was deemed necessary.

Sensitivity Testing

Sensitivity testing of traffic modelling was accounted for by doubling the development flows traffic and adding this to the factored 2047 flows. The results show there is still capacity at the Dublin Road / development Road junction.

12 Cumulative Impacts

Delivery Vehicles & Committed Development

As there is already a café associated with the Breffni Park site, deliveries will likely remain similar to what they are now, circa 2 box van sized vehicle per week.

No committed development has been deemed necessary to consider with the proposed development.

All traffic associated with Breffni Park is already existing on the local and wider network, the pitches that are being provided as part of this scheme are a betterment of existing facilities.

Removing traffic associated with the Royal School drop off and pick up on the Dublin Road will result in a betterment to the immediate area.

Formalising and betterment of the carparking facilities at Breffni Park will result in a betterment to the immediate area.

The formation of a right turn lane into the site will result in a betterment in terms of access to the proposed development.

13 Road Safety

A road safety audit will be carried out as part of this application. Unfortunately, due to RSA reviewing their road traffic collision (RTC) data sharing policies and procedures record-level RTC data is currently unavailable.

14 Environmental Impact

There was a full environmental impact undertaken for this proposed development.

15 Internal Layout

Circulation and Pedestrian Routes

Multiple pedestrian accesses leading to a shared walkway / cycle way which circulates around the entire site are being proposed, this walkway / cycleway will have links to both the Dublin Road and Kilnavarragh Road. This path will have a gradient of no greater than 5% along its entirety to ensure accessibility for all users.

Development Road

The development road will double up as an emergency access / egress for the Breffni Park site. The road into the carpark associated with Breffni Park will be gated and adopted to this point, Cavan County Council will maintain beyond this point. Please refer to drawing package for information.

Right Turn Lane

It is proposed to provide a right turn lane off the Dublin Road into the proposed development. Please refer to drawing package for information.

Visibility and Road Widths

Site lines and road widths for the scheme can be found within the technical drawings submitted as part of this application.

Traffic Management

The carpark associated with Breffni Park will be gated. All traffic management associated with Breffni Park will remain as is currently with traffic management plans issued prior to major events with assistance from the Garda. A similar method will be utilised with any major events associated with the running track or any of the other facilities.

Speed Control Measures

Speed control within the internal roads will be via signage.

Park lane access

It is proposed to stop up Park Lane for vehicles at its junction with Dublin Road, to then merge Park Lane with the proposed new access into the proposed development. This has significant benefits for Park Lane in terms of safety improvements regarding sightlines, approach gradients to the Dublin Road etc.

It is proposed to maintain a footway from the existing Park Lane to facilitate Breffni Park.

16 Parking

Development Parking profile

A parking profile was created by surveying the PEACE Link carpark throughout the day on a Thursday and a Saturday, a factor of x 2 was used in consideration of the size difference between the two sites, this is somewhat of an overestimation however ensures a robust assessment. When applying the factor, the maximum number of parking spaces was 122. However, 160 spaces have been provided with the predicted parking profile indicated in Figure 14.

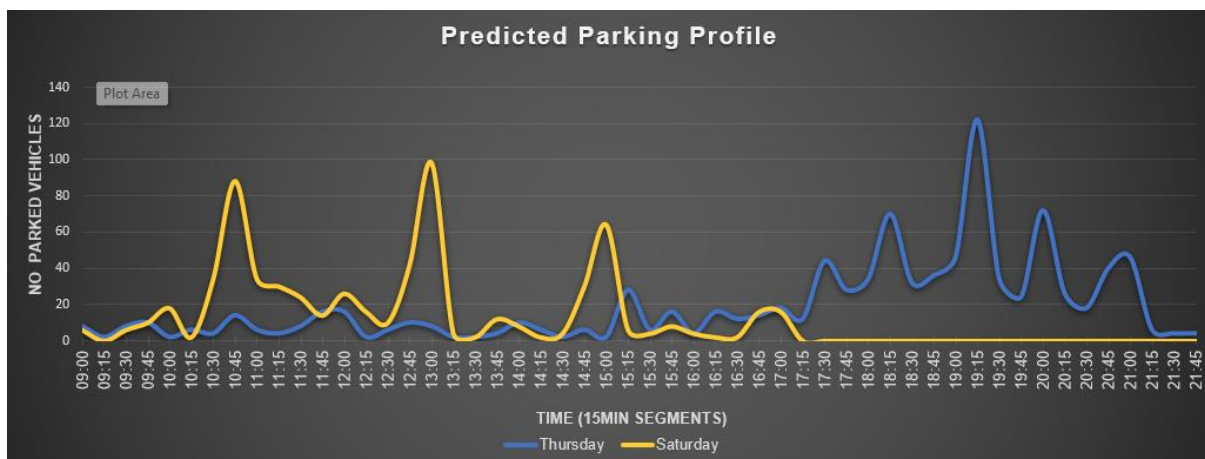

Figure 14: Parking Profile

Four bus spaces are proposed for the sports facility and for the use of the Royal School, this will be utilised by the Royal School during the schools drop off and pick up times. As the school drop off and pick up fall outside the proposed development peak hours there is not clash in terms of parking overall use. Accessible spaces are available closer to the proposed sports facilities accessible only through automated gates.

Breffni Park Parking

As part of the proposed development Breffni Park is receiving a carpark of some 150spaces. This is considered betterment of the Breffni Park complex. Please refer to the planning application package for further information.

17 Public Transport

The closet stop to the proposed site is Breffni Stores, this is served by route C2 highlighted in purple on the below map, the timetables for this route can be found below.

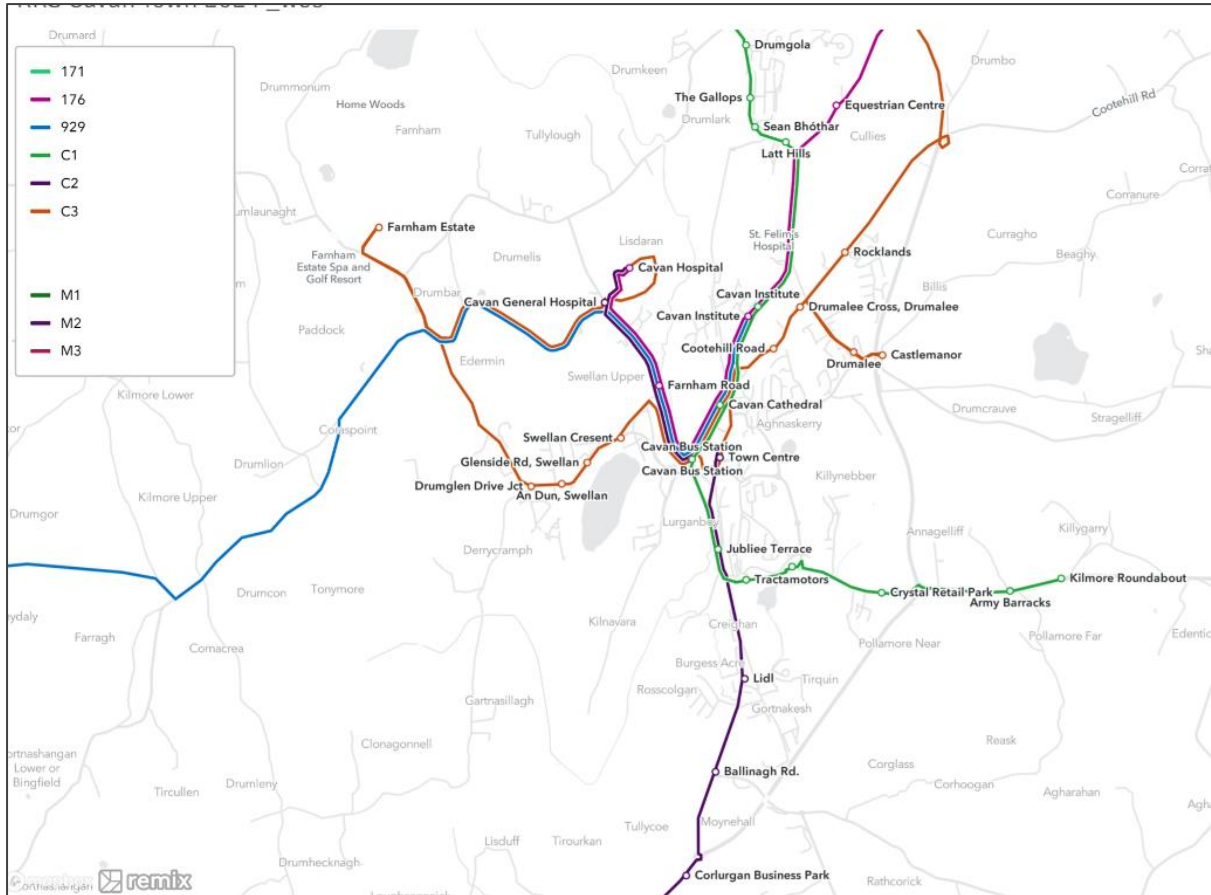

Figure 15: Local Cavan Area Bus Routes

C2 Kilnaleck to Cavan Hospital

KILNALECK TO CAVAN HOSPITAL											
Stops	Monday - Saturday								Friday & Saturday ONLY		
Kilnaleck	-	07:45	09:35	-	12:45	-	15:55	17:46	19:45	-	21:45
Ballinagh, Health Centre	06:45	08:00	09:50	11:25	13:00	14:20	16:10	18:01	20:00	20:45	22:00
Corlurgan	06:53	08:10	10:00	11:35	13:10	14:30	16:20	18:11	20:08	20:53	22:08
Moynehall Lidl	06:55	08:13	10:03	11:38	13:13	14:33	16:23	18:14	20:10	20:55	22:10
Cavan Bus Station	06:59	08:19	10:09	11:44	13:19	14:39	16:29	18:20	20:14	20:59	22:14
Cavan Town Centre	07:01	08:23	10:13	11:48	13:23	14:43	16:33	18:24	20:16	21:01	22:16
Cavan Hospital	07:07	08:32	10:22	11:57	13:32	14:52	16:42	18:33	20:22	21:07	22:22

CAVAN HOSPITAL TO KILNALECK											
Stops	Monday - Saturday								Friday & Saturday ONLY		
Cavan Hospital	07:10	08:35	10:25	12:00	13:35	15:10	17:05	18:33	20:25	21:10	22:25
Cavan Bus Station	07:14	08:41	10:31	12:06	13:41	15:16	17:11	18:39	20:29	21:14	22:29
Cavan Town Centre	07:16	08:44	10:34	12:09	13:44	15:19	17:14	18:42	20:31	21:16	22:31
Moynehall Lidl	07:19	08:49	10:39	12:14	13:49	15:24	17:19	18:47	20:34	21:19	22:34
Corlurgan Business Park	07:21	08:53	10:43	12:18	13:53	15:28	17:23	18:51	20:36	21:21	22:36
Ballinagh, Health Centre	07:28	09:01	10:51	12:26	14:01	15:36	17:31	18:59	20:43	21:28	22:43
Kilnaleck	07:43	09:16	-	12:41	-	15:51	17:46	19:14	-	21:43	-

KILNALECK TO CAVAN HOSPITAL							
Stops	Sunday & Public Holidays						
Kilnaleck	10:00	-	12:30	-	15:20	-	17:50
Ballinagh, Health Centre	10:15	11:10	12:45	14:15	15:35	16:35	18:05
Corlurgan	-	-	-	-	-	-	-
Moynehall Lidl	10:25	11:20	12:55	14:25	15:45	16:45	18:15
Cavan Bus Station	10:29	11:24	12:59	14:29	15:49	16:49	18:19
Cavan Town Centre	10:31	11:26	13:01	14:31	15:51	16:51	18:21
Cavan Hospital	10:37	11:32	13:07	14:37	15:57	16:57	18:27

CAVAN HOSPITAL TO KILNALECK							
Stops	Sunday & Public Holidays						
Cavan Hospital	10:45	11:50	13:15	14:45	16:00	17:00	18:30
Cavan Bus Station	10:49	11:54	13:19	14:49	16:04	17:04	18:34
Cavan Town Centre	10:51	11:56	13:21	14:51	16:06	17:06	18:36
Moynehall Lidl	10:54	11:59	13:24	14:54	16:09	17:09	18:39
Corlurgan Business Park	-	-	-	-	-	-	-
Ballinagh, Health Centre	11:03	12:08	13:33	15:03	16:18	17:18	18:48
Kilnaleck	-	12:23	-	15:18	-	17:33	19:03

Figure 16: C2 Bus Timetables

Regional Connections

There are regional connections in Cavan to Donegal, Dublin, Longford, Athlone, Galway, Cootehill, Monaghan and Belfast. Local Connections in Cavan to Ballyhaise, Butlersbridge, Redhills, Clones, Monaghan, Killeshandra & Ballinamore to Carrick on Shannon.

Conclusion

The proposed site is well served by public transport and as demonstrated by Breffni Park the surrounding road network can accommodate the uplift of additional public transport utilised during large scale events.

18 Pedestrians / Cyclists

ISO Distance Mapping

The following map indicates a 2km walking Iso-Distance from the proposed site which demonstrates that a large section of Cavan town is within walking distance of the proposed site, with the addition of the proposed pedestrian / cycling access points will extend this ISO Distance even further especially to the north and the west of the site.

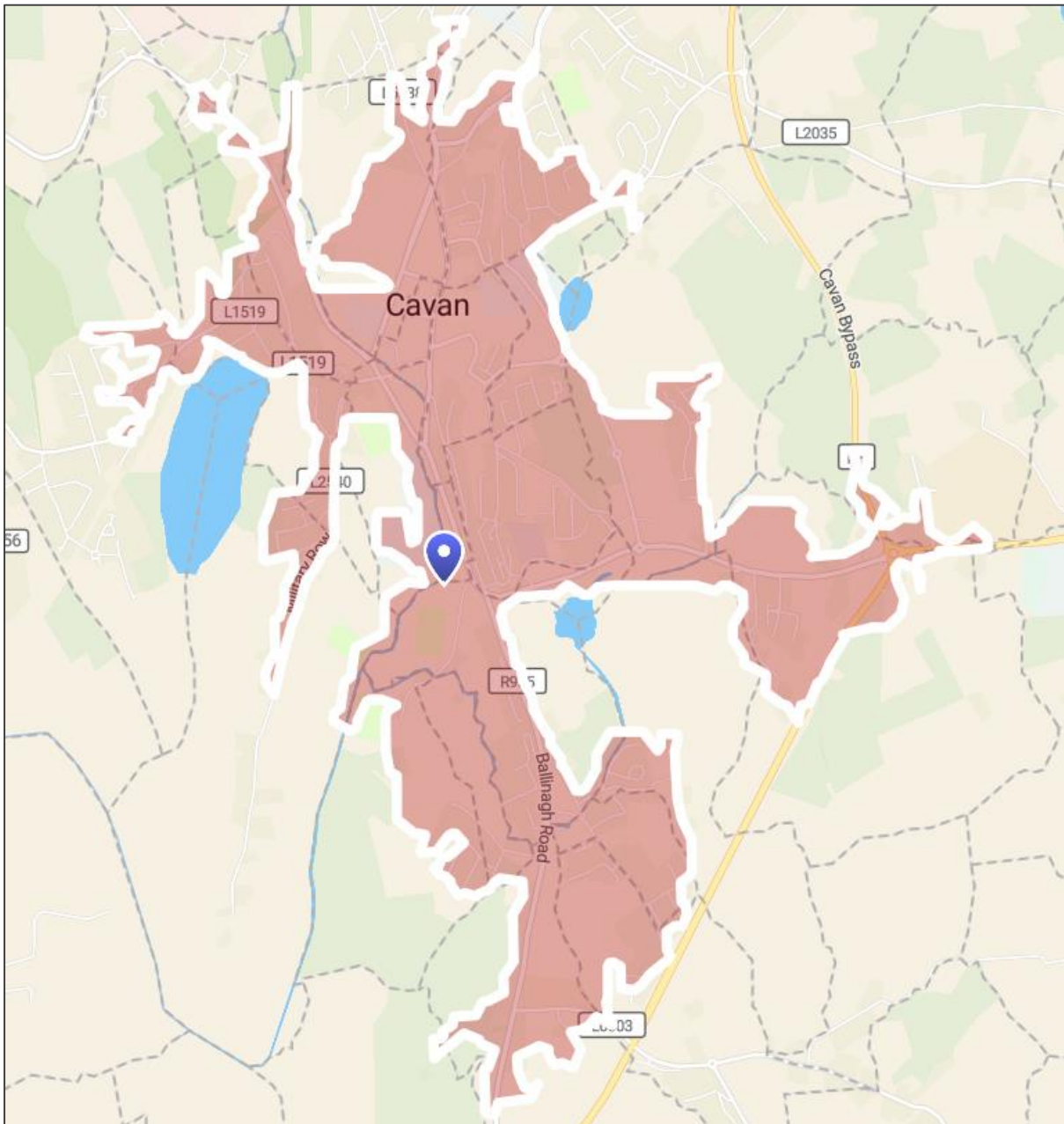

Figure 17: 2km ISO Walking Distance

The following map indicates a 5km cycling ISO Distance from the proposed site which demonstrates that the majority of residential properties within Cavan town are within cycling distance of the proposed site, the addition of the proposed pedestrian / cycling access points will extend this ISO distance even further.

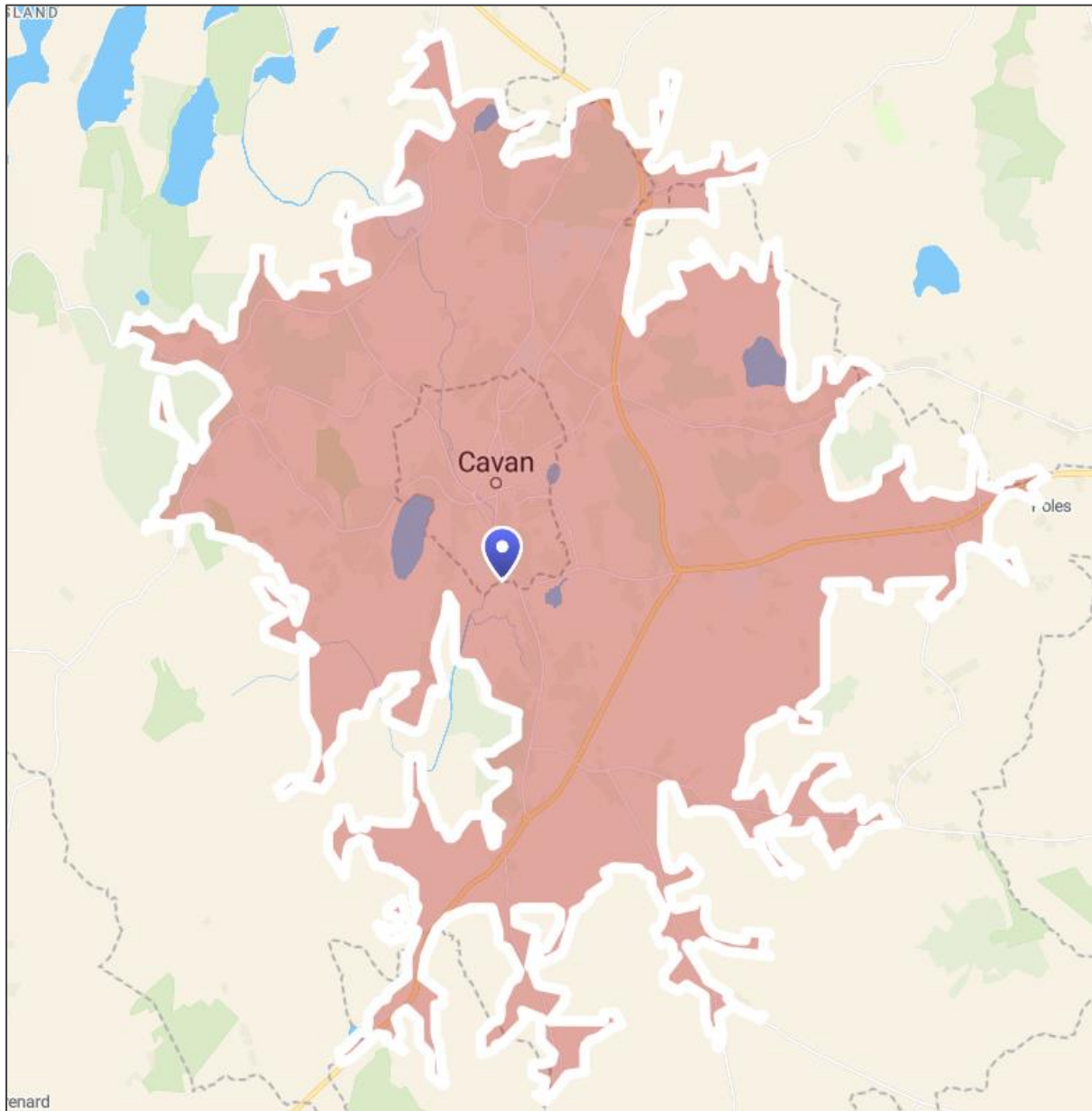

Figure 18: 5km ISO Distance Cycling

Access Points

There are five dedicated public pedestrian / cycle access points with a private access for pedestrians being created to facilitate the Royal School with the main entrance being shared vehicular and pedestrian access. There are also three accesses being created to serve the existing Breffni Park, these have all be numbered on the image below.

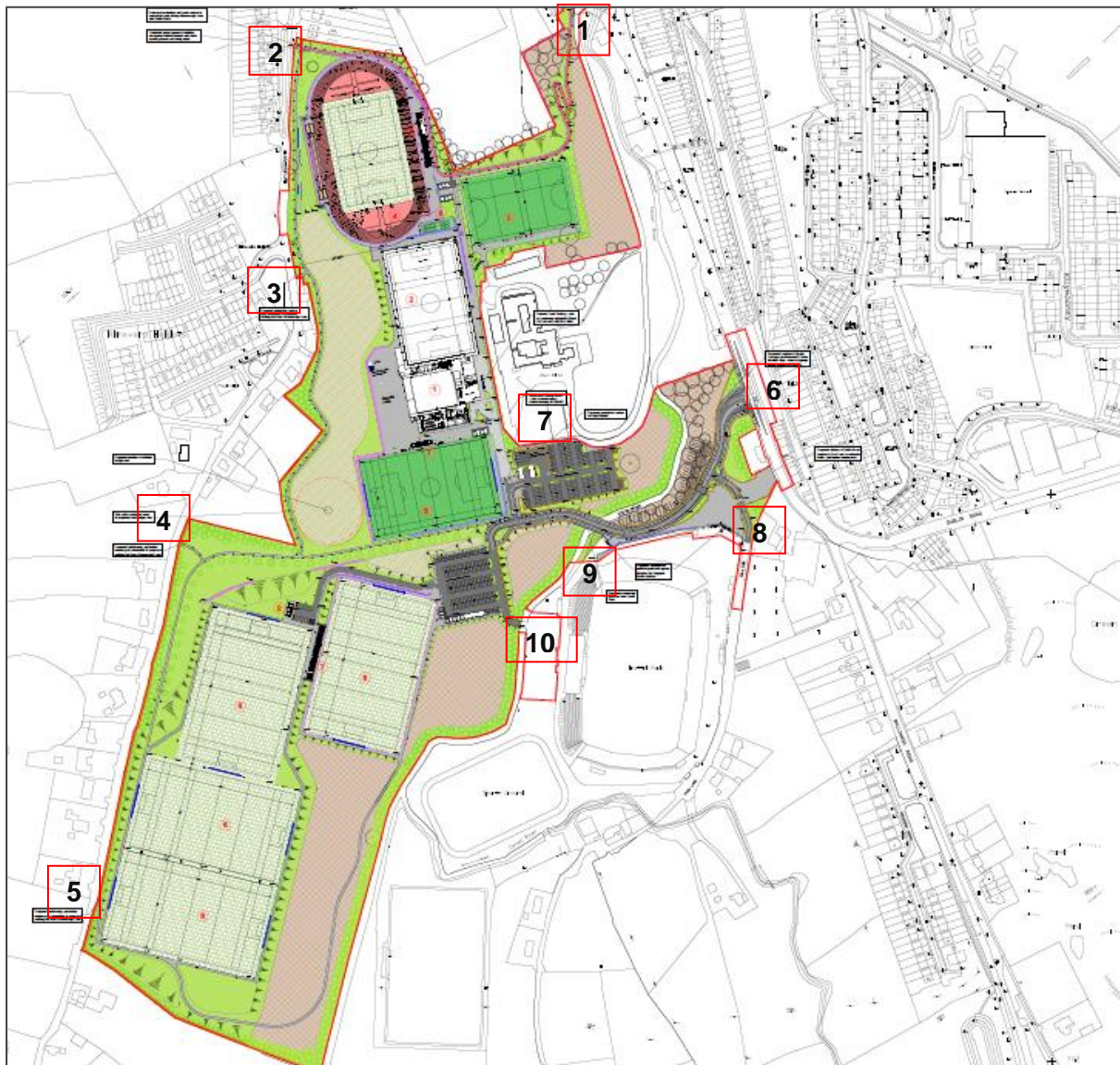

Figure 19: Proposed Access Points

1. Pedestrian / Cycle Access Dublin Road
2. Pedestrian / Cycle Access Kilnavarragh
3. Pedestrian / Cycle Access Kilnavarragh Lane
4. Pedestrian / Cycle Access Kilnavarragh Lane
5. Pedestrian / Cycle Access Kilnavarragh Lane
6. Pedestrian / Cycle Access Dublin Road Main Entrance
7. Pedestrian / Cycle Access Pedestrian Access for the Royal School
8. Shared Access into Breffni Park
9. Shared Access into Breffni Park
10. Pedestrian / Cycle Access into Breffni Park

Internal Layout

The shared footway / cycleway circulates around the proposed site maintaining a 5% gradient throughout. There are two crossing points on the internal road, as well as pedestrian crossing points at either end of the right turn lane and across the main access. These are all detailed within the drawings package.

19 Accessibility and Integration

The accessibility and integration elements are pivotal in determining the efficiency, effectiveness, and equity of transportation networks.

Accessibility

Accessibility refers to the ease with which individuals can reach destinations using the transportation network, ensuring accessibility involves addressing factors such as physical barriers, connectivity, and inclusivity. Key considerations include:

- Infrastructure: The adequacy and condition of transportation infrastructure, including roads, railways, cycle lanes, and footpaths, have been considered to ensure they meet the needs of all users, including pedestrians, cyclists, motorists, and public transport passengers.
- Universal Design: The associated transportation facilities are accessible to people of all ages and abilities; tactile paving, appropriate gradients and designated parking spaces have been provided throughout the entirety of the scheme.
- Public Transport: This has been assessed and has been considered as adequate for the proposed facilities.

Integration

The Integration between different modes of transportation and the coordination of services to provide efficient and convenient journeys is already in place as Breffni Parks facilities are existing and these proposals are a betterment of existing facilities. Breffni Park already utilises Integrated Planning; coordinating land use and transportation planning to ensure that transport networks align with large games and events, thereby reducing travel distances and promoting sustainable mobility.

Local Severance

Local severance refers to the physical and psychological barriers created by transportation infrastructure, which disrupt communities, restrict access to amenities, and contribute to social exclusion. There will be no local severance associated with this planning application.

20 Access for People with Disabilities

The integration of accessibility measures for people with disabilities is a critical aspect of transportation infrastructure development in Ireland. This chapter outlines the guidelines set forth by the Transport Infrastructure Ireland (TII) regarding the assessment and enhancement of accessibility within the transportation network for individuals with disabilities.

Legal Framework and Policy Context

The TII guidelines on access for people with disabilities align with national legislation, including the Disability Act 2005 and the National Disability Inclusion Strategy. These laws mandate the provision of accessible transportation infrastructure to ensure equal opportunities for all citizens, regardless of their physical abilities.

Physical Accessibility: The design includes provision of dropped kerbs, tactile paving, no greater than 5% gradient within the site footways, accessible parking spaces and level access buildings thus ensuring barrier-free access for individuals with mobility impairments.

Wayfinding and Navigation: To ensure the ease of navigation along internal pedestrian routes tactile guidance has been incorporated.

Compliance with Standards: Verifying compliance with relevant accessibility standards and guidelines, such as the European Standard EN 301549 and the Irish National Disability Authority (NDA) guidelines, to ensure that transportation infrastructure meets minimum accessibility requirements.

21 Mitigation & Conclusion

The mitigation strategies outlined in this chapter aim to address traffic congestion, improve safety, and enhance pedestrian access. Key measures include the introduction of a right turn lane, enhancements to Park Lane's sightlines and approach, rerouting of school buses, implementation of dual egress lanes, and provision of pedestrian accesses.

Right Turn Lane

To alleviate congestion at the proposed entrance on the Dublin Road, the implementation of a dedicated right turn lane is proposed.

Park Lane Improvements

The proposed arrangement at Park Lane will improve the existing sightlines and steep approach. These adjustments to road geometry will improve visibility and reduce the likelihood of accidents at this junction.

School Bus Re-routing

To mitigate the impact of school buses and private vehicles associated with the Royal School on traffic congestion along the Dublin Road, re-routing the aforementioned vehicles into the proposed upper carpark will divert them away from the busiest sections of the Dublin Road corridor, thereby reducing delays and improving overall traffic flow.

Dual Egress Lanes

The introduction of dual egress lanes at the exit of the proposed development onto the Dublin Road will enhance capacity and facilitate smoother traffic dispersal. By providing two lanes for exiting vehicles, congestion during the sites peak hours will be reduced, and queuing delays minimized, thereby improving journey times for motorists.

Pedestrian Accesses

Improving pedestrian accesses around the proposed site is crucial for enhancing safety and promoting active transportation. Measures such as the installation of pedestrian crossings, tactile paving, and dedicated internal pedestrian pathways will be implemented to facilitate safe and convenient movement for pedestrians, including those with mobility impairments.

Construction Mitigation

Working hours will be limited to avoid unsociable hours. Construction works shall be restricted to between 08:00hrs and 18:00hrs on weekdays and between 08:00hrs and 13:00hrs on Saturdays. There will be no works carried out on Sundays or Bank Holidays.

Conclusion

In conclusion the proposed development peak hours of traffic operation fall outside the existing peak hours of existing traffic network, therefore in traffic terms the impact is minimal with significant benefit to sustainable transport and footpath links throughout Cavan. The provision of a right turn lane will assist in benefiting vehicles turning right into the proposed development whilst facilitating through traffic.

In addition to the health benefits of the scheme, the scheme also brings significant benefits relating to Park Lane realignment; Breffni Park new parking and pitches; the Royal School new drop off for parents and buses; and removing that traffic from the existing school site.

Impact of the Proposed Development

Given the result of this study it is considered the traffic impact of the proposed is negligible to slight on the receiving environment.

Appendix A – Person Trip Generation

	Peds			
	Thursday		Saturday	
	2 Ratio for peds from Peace Link Surveys			
	Proposed		Proposed	
	In	Out	In	Out
09:00	2	0	0	0
09:15	0	0	0	0
09:30	0	0	0	2
09:45	0	0	2	0
10:00	0	2	6	2
10:15	0	0	0	0
10:30	0	0	0	0
10:45	0	0	0	8
11:00	0	0	0	2
11:15	0	0	2	0
11:30	4	2	10	2
11:45	0	0	2	0
12:00	0	2	0	2
12:15	0	0	0	6
12:30	0	0	6	0
12:45	0	0	6	4
13:00	0	0	8	6
13:15	2	0	0	2
13:30	0	2	0	2
13:45	4	0	0	0
14:00	2	0	0	0
14:15	0	2	0	0
14:30	2	2	0	0
14:45	2	0	8	4
15:00	2	2	4	8
15:15	2	4	0	0
15:30	2	0	0	0
15:45	2	0	0	0
16:00	16	2	0	0
16:15	8	6	0	2
16:30	4	4	0	0
16:45	0	14	0	2
17:00	0	2	0	6
17:15	0	4	0	0
17:30	0	0	0	0
17:45	0	2	0	0
18:00	2	0	0	0
18:15	0	6	0	0
18:30	2	0	0	0
18:45	4	2	0	0
19:00	6	24	0	0
19:15	0	0	0	0
19:30	0	2	0	0
19:45	12	0	0	0
20:00	16	12	0	0
20:15	14	0	0	0
20:30	6	0	0	0
20:45	0	0	0	0
21:00	0	4	0	0
21:15	0	2	0	0
21:30	0	0	0	0
21:45	0	0	0	0
	116	104	54	60

Appendix B – Traffic Generation

Vehicle Profile					
	Thursday			Saturday	
	1.5 Ratio for proposed vehicles from Peace Link				
	Proposed Vehicle Profile				
	In	Out	In	Out	
09:00	6	0	3	1.5	
09:15	1.5	0	0	0	
09:30	3	3	3	1.5	
09:45	3	4.5	6	1.5	
10:00	1.5	0	6	7.5	
10:15	1.5	3	0	1.5	
10:30	1.5	1.5	18	4.5	
10:45	9	1.5	36	30	
11:00	1.5	3	15	9	
11:15	1.5	1.5	18	1.5	
11:30	4.5	1.5	12	4.5	
11:45	3	9	6	3	
12:00	4.5	7.5	10.5	9	
12:15	1.5	0	1.5	10.5	
12:30	0	4.5	4.5	3	
12:45	6	1.5	12	19.5	
13:00	0	6	12	60	
13:15	1.5	0	3	0	
13:30	0	1.5	1.5	0	
13:45	3	0	3	4.5	
14:00	3	4.5	1.5	4.5	
14:15	4.5	0	0	1.5	
14:30	1.5	0	3	0	
14:45	3	1.5	18	4.5	
15:00	1.5	0	15	31.5	
15:15	12	9	3	1.5	
15:30	4.5	0	3	0	
15:45	7.5	4.5	1.5	4.5	
16:00	1.5	1.5	1.5	1.5	
16:15	3	9	0	1.5	
16:30	3	6	0	0	
16:45	1.5	9	6	6	
17:00	7.5	6	1.5	10.5	
17:15	7.5	1.5	0	0	
17:30	27	6	0	0	
17:45	18	3	0	0	
18:00	25.5	0	0	0	
18:15	39	13.5	0	0	
18:30	16.5	7.5	0	0	
18:45	21	6	0	0	
19:00	27	7.5	0	0	
19:15	28.5	63	0	0	
19:30	18	7.5	0	0	
19:45	12	6	0	0	
20:00	15	39	0	0	
20:15	9	10.5	0	0	
20:30	4.5	9	0	0	
20:45	1.5	28.5	0	0	
21:00	0	34.5	0	0	
21:15	0	4.5	0	0	
21:30	0	3	0	0	
21:45	0	3	0	0	
	378	354	225	240	

Appendix C – Junctions 10 Modelling

Junctions 10
PICADY 10 - Priority Intersection Module
Version: 10.1.0.1820 © Copyright TRL Software Limited, 2023
For sales and distribution information, program advice and maintenance, contact TRL Software: +44 (0)1344 379777 software@trl.co.uk trlsoftware.com
The users of this computer program for the solution of an engineering problem are in no way relieved of their responsibility for the correctness of the solution

Filename: 240304_Site_Access_Development_Only.j10
 Path: C:\Users\MartinHoy\Hoy & Dorman Ltd\Hoy Dorman - Documents\Civils\2023001_Cavan_Sports_Facility\2.0 Work\2.2 Traffic
 Report generation date: 06/03/2024 13:21:20

- »2023, AM
- »2027 - Opening Year, AM
- »Development Flows, AM
- »2027 + Development Flows, AM
- »2032 Faactored Base + 5yrs, AM
- »2032 Faactored Base + Dev Flows = +5yrs, AM
- »2042 Faactored Base + 15yrs, AM
- »2042 Faactored Base + 15yrs + Dev Flows, AM
- »2042 Faactored Base + 15yrs + Dev Flows x 2, AM
- »2023, PM
- »2027 - Opening Year, PM
- »Development Flows, PM
- »2027 + Development Flows, PM
- »2032 Faactored Base + 5yrs, PM
- »2032 Faactored Base + Dev Flows = +5yrs, PM
- »2042 Faactored Base + 15yrs, PM
- »2042 Faactored Base + 15yrs + Dev Flows, PM
- »2042 Faactored Base + 15yrs + Dev Flows x 2, PM

Summary of junction performance

	AM									PM									
	Set ID	Queue (Veh)	95% Queue (Veh)	Delay (s)	RFC	LOS	Junction Delay (s)	Junction LOS	Network Residual Capacity	Set ID	Queue (Veh)	95% Queue (Veh)	Delay (s)	RFC	LOS	Junction Delay (s)	Junction LOS	Network Residual Capacity	
2023																			
Stream B-AC	D1	0.0	~1	0.00	0.00	A	0.00	A	900 %	D10	0.0	~1	0.00	0.00	A	0.00	A	900 %	
Stream C-AB		0.0	~1	0.00	0.00	A					0.0	~1	0.00	0.00	A				
2027 - Opening Year																			
Stream B-AC	D2	0.0	~1	0.00	0.00	A	0.00	A	900 %	D11	0.0	~1	0.00	0.00	A	0.00	A	900 %	
Stream C-AB		0.0	~1	0.00	0.00	A					0.0	~1	0.00	0.00	A				
Development Flows																			
Stream B-AC	D3	0.0	0.5	6.22	0.02	A	4.61	A	900 %	D12	0.0	0.5	6.32	0.02	A	4.96	A	678 % [Stream C-AB]	
Stream C-AB		0.0	0.5	5.57	0.02	A					0.1	0.5	6.11	0.10	A				
2027 + Development Flows																			
Stream B-AC	D4	0.3	1.5	12.75	0.25	B	1.27	A	58 % [Stream B-AC]	D13	0.3	1.2	13.81	0.21	B	0.87	A	41 % [Stream B-AC]	
Stream C-AB		0.1	0.5	7.57	0.11	A					0.2	0.5	8.08	0.13	A				
2032 Faactored Base + 5yrs																			
Stream B-AC	D5	0.0	~1	0.00	0.00	A	0.00	A	900 %	D14	0.0	~1	0.00	0.00	A	0.00	A	900 %	
Stream C-AB		0.0	~1	0.00	0.00	A					0.0	~1	0.00	0.00	A				
2032 Faactored Base + Dev Flows = +5yrs																			
Stream B-AC	D6	0.3	1.0	13.02	0.26	B	1.26	A	55 % [Stream B-AC]	D15	0.3	1.3	14.27	0.22	B	0.87	A	38 % [Stream B-AC]	
Stream C-AB		0.1	0.5	7.63	0.12	A					0.2	0.5	8.15	0.13	A				
2042 Faactored Base + 15yrs																			
Stream B-AC	D7	0.0	~1	0.00	0.00	A	0.00	A	900 %	D16	0.0	~1	0.00	0.00	A	0.00	A	900 %	
Stream C-AB		0.0	~1	0.00	0.00	A					0.0	~1	0.00	0.00	A				
2042 Faactored Base + 15yrs + Dev Flows																			
Stream B-AC	D8	0.3	1.1	13.20	0.26	B	1.26	A	53 % [Stream B-AC]	D17	0.3	1.3	14.59	0.22	B	0.87	A	36 % [Stream B-AC]	
Stream C-AB		0.1	0.5	7.66	0.12	A					0.2	0.5	8.20	0.13	A				
2042 Faactored Base + 15yrs + Dev Flows x 2																			
									12 %										10 %

Stream B-AC	D9	1.2	5.2	23.09	0.55	C	3.46	A	[Stream B-AC]	D18	0.9	4.4	23.98	0.48	C	2.33	A	[Stream B-AC]
Stream C-AB		0.3	1.4	9.09	0.24	A					0.4	1.5	10.03	0.28	B			

There are warnings associated with one or more model runs - see the 'Data Errors and Warnings' tables for each Analysis or Demand Set.

Values shown are the highest values encountered over all time segments. Delay is the maximum value of average delay per arriving vehicle. Junction LOS and Junction Delay are demand-weighted averages. Network Residual Capacity indicates the amount by which network flow could be increased before a user-definable threshold (see Analysis Options) is met.

File summary

File Description

Title	
Location	
Site number	
Date	07/11/2023
Version	
Status	(new file)
Identifier	
Client	
Jobnumber	
Enumerator	AzureAD\MartinHoy
Description	

Units

Distance units	Speed units	Traffic units input	Traffic units results	Flow units	Average delay units	Total delay units	Rate of delay units
m	kph	Veh	Veh	perHour	s	-Min	perMin

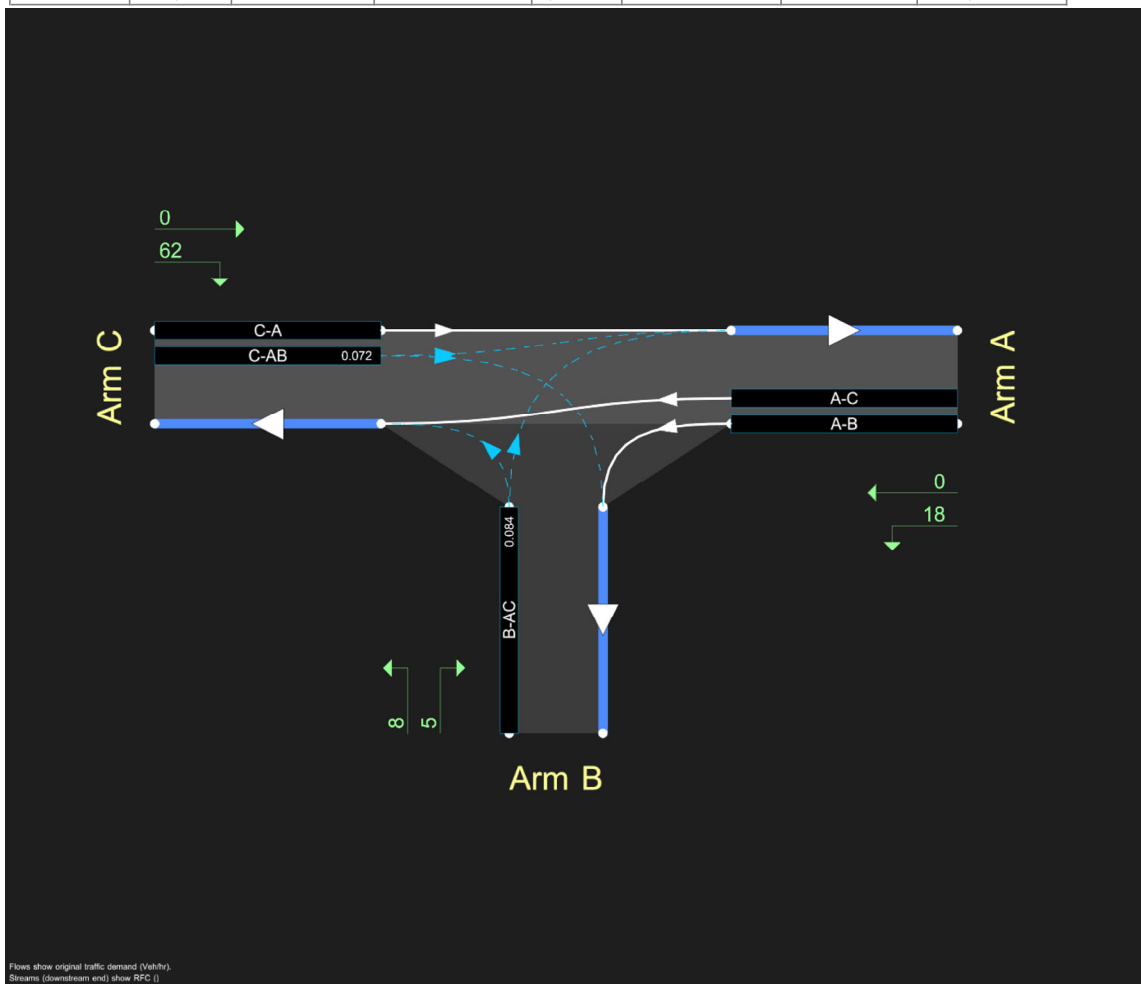

The junction diagram reflects the last run of Junctions.

Analysis Options

Vehicle length (m)	Calculate Queue Percentiles	Calculate detailed queueing delay	Show lane queues in feet / metres	Show all PICADY stream intercepts	Calculate residual capacity	Residual capacity criteria type	RFC Threshold	Average Delay threshold (s)	Queue threshold (PCU)	Use iterations with HCM roundabouts	Max number of iterations for roundabouts
5.75	✓				✓	Delay	0.85	36.00	20.00		500

Demand Set Summary

--	--	--	--	--	--	--	--	--	--	--	--

ID	Scenario name	Time Period name	Traffic profile type	Start time (HH:mm)	Finish time (HH:mm)	Time segment length (min)	Run automatically	Relationship type	Relationship
D1	2023	AM	ONE HOUR	09:00	10:30	15	✓		
D2	2027 - Opening Year	AM	ONE HOUR	09:00	10:30	15	✓	Simple	D1*G1
D3	Development Flows	AM	ONE HOUR	09:00	10:30	15	✓		
D4	2027 + Development Flows	AM	ONE HOUR	09:00	10:30	15	✓	Simple	D2+D3
D5	2032 Faactored Base + 5yrs	AM	ONE HOUR	09:00	10:30	15	✓	Simple	D1*G2
D6	2032 Faactored Base + Dev Flows = +5yrs	AM	ONE HOUR	09:00	10:30	15	✓	Simple	D3+D5
D7	2042 Faactored Base + 15yrs	AM	ONE HOUR	09:00	10:30	15	✓	Simple	D1*G3
D8	2042 Faactored Base + 15yrs + Dev Flows	AM	ONE HOUR	09:00	10:30	15	✓	Simple	D3+D7
D9	2042 Faactored Base + 15yrs + Dev Flows x 2	AM	ONE HOUR	09:00	10:30	15	✓	Simple	(D3*2)+D7
D10	2023	PM	ONE HOUR	15:00	16:30	15	✓		
D11	2027 - Opening Year	PM	ONE HOUR	15:00	16:30	15	✓	Simple	D10*G1
D12	Development Flows	PM	ONE HOUR	15:00	16:30	15	✓		
D13	2027 + Development Flows	PM	ONE HOUR	15:00	16:30	15	✓	Simple	D11+D12
D14	2032 Faactored Base + 5yrs	PM	ONE HOUR	15:00	16:30	15	✓	Simple	D10*G2
D15	2032 Faactored Base + Dev Flows = +5yrs	PM	ONE HOUR	15:00	16:30	15	✓	Simple	D12+D14
D16	2042 Faactored Base + 15yrs	PM	ONE HOUR	15:00	16:30	15	✓	Simple	D10*G3
D17	2042 Faactored Base + 15yrs + Dev Flows	PM	ONE HOUR	15:00	16:30	15	✓	Simple	D12+D16
D18	2042 Faactored Base + 15yrs + Dev Flows x 2	PM	ONE HOUR	15:00	16:30	15	✓	Simple	(D12*2)+D16

Growth Factors

ID	Description	Use TEMPRO	Growth Factor
G1			1.0490
G2			1.0830
G3			1.1044

Growth factors are only active if the Demand Set references them in a Relationship.

Analysis Set Details

ID	Include in report	Network flow scaling factor (%)	Network capacity scaling factor (%)
A1	✓	100.000	100.000

2023, AM

Data Errors and Warnings

Severity	Area	Item	Description
Warning	Demand Set Relationship	D4 - 2027 + Development Flows, AM	Demand Set relationships are chained. This may slow down the file.
Warning	Vehicle Mix		HV% is zero for all movements / time segments. Vehicle Mix matrix should be completed whether working in PCUs or Vehs. If HV% at the junction is genuinely zero, please ignore this warning.
Warning	Queue variations	Analysis Options	Queue percentiles may be unreliable if the mean queue in any time segment is very low or very high.

Junction Network

Junctions

Junction	Name	Junction type	Arm A Direction	Arm B Direction	Arm C Direction	Use circulating lanes	Junction Delay (s)	Junction LOS
1	Development Access	T-Junction	Two-way	Two-way	Two-way		0.00	A

Junction Network

Driving side	Lighting	Network residual capacity (%)	First arm reaching threshold	Network delay (s)	Network LOS
Left	Normal/unknown	900		0.00	A

Arms

Arms

Arm	Name	Description	Arm type
A	untitled		Major
B	untitled		Minor
C	untitled		Major

Major Arm Geometry

Arm	Width of carriageway (m)	Has kerbed central reserve	Has right-turn storage	Width for right-turn storage (m)	Visibility for right turn (m)	Blocks?	Blocking queue (PCU)
C	8.50		✓	2.50	115.0	✓	4.00

Geometries for Arm C are measured opposite Arm B. Geometries for Arm A (if relevant) are measured opposite Arm D.

Minor Arm Geometry

Arm	Minor arm type	Lane width (m)	Visibility to left (m)	Visibility to right (m)
B	One lane	3.00	77	44

Slope / Intercept / Capacity

Priority Intersection Slopes and Intercepts

Stream	Intercept (Veh/hr)	Slope for A-B	Slope for A-C	Slope for C-A	Slope for C-B
B-A	524	0.085	0.215	0.135	0.307
B-C	652	0.089	0.225	-	-
C-B	661	0.228	0.228	-	-

The slopes and intercepts shown above include custom intercept adjustments only.

Streams may be combined, in which case capacity will be adjusted.

Values are shown for the first time segment only; they may differ for subsequent time segments.

Traffic Demand

Demand Set Details

ID	Scenario name	Time Period name	Traffic profile type	Start time (HH:mm)	Finish time (HH:mm)	Time segment length (min)	Run automatically
D1	2023	AM	ONE HOUR	09:00	10:30	15	✓

Demand overview (Traffic)

Arm	Linked arm	Profile type	Use O-D data	Average Demand (Veh/hr)	Scaling Factor (%)
A		ONE HOUR	✓	420	100.000
B		ONE HOUR	✓	0	100.000
C		ONE HOUR	✓	530	100.000

Origin-Destination Data

Demand (Veh/hr)

		To			
		A	B	C	
From	A	0	0	420	
	B	0	0	0	
	C	530	0	0	

Proportions

		To			
		A	B	C	
From	A	0.00	0.00	1.00	
	B	0.33	0.33	0.33	
	C	1.00	0.00	0.00	

Vehicle Mix

HV data entry mode	PCU Factor for a HV (PCU)
HV Percentages	2.00

Heavy Vehicle %

		To			
		A	B	C	
From	A	0	0	0	
	B	0	0	0	
	C	0	0	0	

Average PCU Per Veh

		To			
		A	B	C	
From	A	1.000	1.000	1.000	
	B	1.000	1.000	1.000	
	C	1.000	1.000	1.000	

Detailed Demand Data

Demand for each time segment

Arm	Time Segment	Demand (Veh/hr)	Demand in PCU (PCU/hr)
A	09:00-09:15	316	316
	09:15-09:30	378	378
	09:30-09:45	462	462
	09:45-10:00	462	462
	10:00-10:15	378	378
	10:15-10:30	316	316
B	09:00-09:15	0	0
	09:15-09:30	0	0
	09:30-09:45	0	0
	09:45-10:00	0	0
	10:00-10:15	0	0
	10:15-10:30	0	0
C	09:00-09:15	399	399
	09:15-09:30	476	476
	09:30-09:45	584	584
	09:45-10:00	584	584
	10:00-10:15	476	476
	10:15-10:30	399	399

Results

Results Summary for whole modelled period

Stream	Max RFC	Max Delay (s)	Max Queue (Veh)	Max 95th percentile Queue (Veh)	Max LOS	Average Demand (Veh/hr)	Total Junction Arrivals (Veh)
B-AC	0.00	0.00	0.0	~1	A	0	0
C-AB	0.00	0.00	0.0	~1	A	0	0
C-A						486	730
A-B						0	0
A-C						385	578

Main Results for each time segment

09:00 - 09:15

Stream	Total Demand (Veh/hr)	Junction Arrivals (Veh)	Capacity (Veh/hr)	RFC	Throughput (Veh/hr)	Start queue (Veh)	End queue (Veh)	Delay (s)	Unsignalised level of service
B-AC	0	0	475	0.000	0	0.0	0.0	0.000	A
C-AB	0	0	1179	0.000	0	0.0	0.0	0.000	A
C-A	399	100			399				
A-B	0	0			0				
A-C	316	79			316				

09:15 - 09:30

--	--	--	--	--	--	--	--	--	--

Stream	Total Demand (Veh/hr)	Junction Arrivals (Veh)	Capacity (Veh/hr)	RFC	Throughput (Veh/hr)	Start queue (Veh)	End queue (Veh)	Delay (s)	Unsignalised level of service
B-AC	0	0	454	0.000	0	0.0	0.0	0.000	A
C-AB	0	0	1150	0.000	0	0.0	0.0	0.000	A
C-A	476	119			476				
A-B	0	0			0				
A-C	378	94			378				

09:30 - 09:45

Stream	Total Demand (Veh/hr)	Junction Arrivals (Veh)	Capacity (Veh/hr)	RFC	Throughput (Veh/hr)	Start queue (Veh)	End queue (Veh)	Delay (s)	Unsignalised level of service
B-AC	0	0	424	0.000	0	0.0	0.0	0.000	A
C-AB	0	0	1112	0.000	0	0.0	0.0	0.000	A
C-A	584	146			584				
A-B	0	0			0				
A-C	462	116			462				

09:45 - 10:00

Stream	Total Demand (Veh/hr)	Junction Arrivals (Veh)	Capacity (Veh/hr)	RFC	Throughput (Veh/hr)	Start queue (Veh)	End queue (Veh)	Delay (s)	Unsignalised level of service
B-AC	0	0	424	0.000	0	0.0	0.0	0.000	A
C-AB	0	0	1112	0.000	0	0.0	0.0	0.000	A
C-A	584	146			584				
A-B	0	0			0				
A-C	462	116			462				

10:00 - 10:15

Stream	Total Demand (Veh/hr)	Junction Arrivals (Veh)	Capacity (Veh/hr)	RFC	Throughput (Veh/hr)	Start queue (Veh)	End queue (Veh)	Delay (s)	Unsignalised level of service
B-AC	0	0	454	0.000	0	0.0	0.0	0.000	A
C-AB	0	0	1150	0.000	0	0.0	0.0	0.000	A
C-A	476	119			476				
A-B	0	0			0				
A-C	378	94			378				

10:15 - 10:30

Stream	Total Demand (Veh/hr)	Junction Arrivals (Veh)	Capacity (Veh/hr)	RFC	Throughput (Veh/hr)	Start queue (Veh)	End queue (Veh)	Delay (s)	Unsignalised level of service
B-AC	0	0	475	0.000	0	0.0	0.0	0.000	A
C-AB	0	0	1179	0.000	0	0.0	0.0	0.000	A
C-A	399	100			399				
A-B	0	0			0				
A-C	316	79			316				

Queue Variation Results for each time segment**09:00 - 09:15**

Stream	Mean (Veh)	Q05 (Veh)	Q50 (Veh)	Q90 (Veh)	Q95 (Veh)	Percentile message	Marker message	Probability of reaching or exceeding marker	Probability of exactly reaching marker
B-AC	0.00	0.00	0.00	0.00	0.00			N/A	N/A
C-AB	0.00	0.00	0.00	0.00	0.00			N/A	N/A

09:15 - 09:30

Stream	Mean (Veh)	Q05 (Veh)	Q50 (Veh)	Q90 (Veh)	Q95 (Veh)	Percentile message	Marker message	Probability of reaching or exceeding marker	Probability of exactly reaching marker
B-AC	0.00	0.00	0.00	0.00	0.00			N/A	N/A
C-AB	0.00	0.00	0.00	0.00	0.00			N/A	N/A

09:30 - 09:45

Stream	Mean (Veh)	Q05 (Veh)	Q50 (Veh)	Q90 (Veh)	Q95 (Veh)	Percentile message	Marker message	Probability of reaching or exceeding marker	Probability of exactly reaching marker
B-AC	0.00	0.00	0.00	0.00	0.00			N/A	N/A
C-AB	0.00	0.00	0.00	0.00	0.00			N/A	N/A

09:45 - 10:00

Stream	Mean (Veh)	Q05 (Veh)	Q50 (Veh)	Q90 (Veh)	Q95 (Veh)	Percentile message	Marker message	Probability of reaching or exceeding marker	Probability of exactly reaching marker
B-AC	0.00	0.00	0.00	0.00	0.00			N/A	N/A
C-AB	0.00	0.00	0.00	0.00	0.00			N/A	N/A

10:00 - 10:15

Stream	Mean (Veh)	Q05 (Veh)	Q50 (Veh)	Q90 (Veh)	Q95 (Veh)	Percentile message	Marker message	Probability of reaching or exceeding marker	Probability of exactly reaching marker
B-AC	0.00	0.00	0.00	0.00	0.00			N/A	N/A
C-AB	0.00	0.00	0.00	0.00	0.00			N/A	N/A

10:15 - 10:30

Stream	Mean (Veh)	Q05 (Veh)	Q50 (Veh)	Q90 (Veh)	Q95 (Veh)	Percentile message	Marker message	Probability of reaching or exceeding marker	Probability of exactly reaching marker
B-AC	0.00	0.00	0.00	0.00	0.00			N/A	N/A
C-AB	0.00	0.00	0.00	0.00	0.00			N/A	N/A

2027 - Opening Year, AM

Data Errors and Warnings

Severity	Area	Item	Description
Warning	Demand Set Relationship	D4 - 2027 + Development Flows, AM	Demand Set relationships are chained. This may slow down the file.
Warning	Vehicle Mix		HV% is zero for all movements / time segments. Vehicle Mix matrix should be completed whether working in PCUs or Vehs. If HV% at the junction is genuinely zero, please ignore this warning.
Warning	Queue variations	Analysis Options	Queue percentiles may be unreliable if the mean queue in any time segment is very low or very high.

Junction Network

Junctions

Junction	Name	Junction type	Arm A Direction	Arm B Direction	Arm C Direction	Use circulating lanes	Junction Delay (s)	Junction LOS
1	Development Access	T-Junction	Two-way	Two-way	Two-way		0.00	A

Junction Network

Driving side	Lighting	Network residual capacity (%)	First arm reaching threshold	Network delay (s)	Network LOS
Left	Normal/unknown	900		0.00	A

Traffic Demand

Demand Set Details

ID	Scenario name	Time Period name	Traffic profile type	Start time (HH:mm)	Finish time (HH:mm)	Time segment length (min)	Run automatically	Relationship type	Relationship
D2	2027 - Opening Year	AM	ONE HOUR	09:00	10:30	15	✓	Simple	D1*G1

Demand overview (Traffic)

Arm	Linked arm	Profile type	Use O-D data	Average Demand (Veh/hr)	Scaling Factor (%)
A		ONE HOUR	✓	441	100.000
B		ONE HOUR	✓	0	100.000
C		ONE HOUR	✓	556	100.000

Origin-Destination Data

Demand (Veh/hr)

		To		
		A	B	C
From	A	0	0	441
	B	0	0	0
	C	556	0	0

Proportions

		To		
		A	B	C
From	A	0.00	0.00	1.00
	B	0.33	0.33	0.33
	C	1.00	0.00	0.00

Vehicle Mix

HV data entry mode	PCU Factor for a HV (PCU)
HV Percentages	2.00

Heavy Vehicle %

		To		
		A	B	C
From	A	0	0	0
	B	0	0	0
	C	0	0	0

Average PCU Per Veh

		To		
		A	B	C
From	A	1.000	1.000	1.000
	B	1.000	1.000	1.000
	C	1.000	1.000	1.000

Detailed Demand Data

Demand for each time segment

Arm	Time Segment	Demand (Veh/hr)	Demand in PCU (PCU/hr)
A	09:00-09:15	332	332
	09:15-09:30	396	396
	09:30-09:45	485	485
	09:45-10:00	485	485
	10:00-10:15	396	396

	10:15-10:30	332	332
B	09:00-09:15	0	0
	09:15-09:30	0	0
	09:30-09:45	0	0
	09:45-10:00	0	0
	10:00-10:15	0	0
	10:15-10:30	0	0
C	09:00-09:15	419	419
	09:15-09:30	500	500
	09:30-09:45	612	612
	09:45-10:00	612	612
	10:00-10:15	500	500
	10:15-10:30	419	419

Results

Results Summary for whole modelled period

Stream	Max RFC	Max Delay (s)	Max Queue (Veh)	Max 95th percentile Queue (Veh)	Max LOS	Average Demand (Veh/hr)	Total Junction Arrivals (Veh)
B-AC	0.00	0.00	0.0	~1	A	0	0
C-AB	0.00	0.00	0.0	~1	A	0	0
C-A						510	765
A-B						0	0
A-C						404	606

Main Results for each time segment

09:00 - 09:15

Stream	Total Demand (Veh/hr)	Junction Arrivals (Veh)	Capacity (Veh/hr)	RFC	Throughput (Veh/hr)	Start queue (Veh)	End queue (Veh)	Delay (s)	Unsignalised level of service
B-AC	0	0	470	0.000	0	0.0	0.0	0.000	A
C-AB	0	0	1171	0.000	0	0.0	0.0	0.000	A
C-A	419	105			419				
A-B	0	0			0				
A-C	332	83			332				

09:15 - 09:30

Stream	Total Demand (Veh/hr)	Junction Arrivals (Veh)	Capacity (Veh/hr)	RFC	Throughput (Veh/hr)	Start queue (Veh)	End queue (Veh)	Delay (s)	Unsignalised level of service
B-AC	0	0	447	0.000	0	0.0	0.0	0.000	A
C-AB	0	0	1142	0.000	0	0.0	0.0	0.000	A
C-A	500	125			500				
A-B	0	0			0				
A-C	396	99			396				

09:30 - 09:45

Stream	Total Demand (Veh/hr)	Junction Arrivals (Veh)	Capacity (Veh/hr)	RFC	Throughput (Veh/hr)	Start queue (Veh)	End queue (Veh)	Delay (s)	Unsignalised level of service
B-AC	0	0	416	0.000	0	0.0	0.0	0.000	A
C-AB	0	0	1101	0.000	0	0.0	0.0	0.000	A
C-A	612	153			612				
A-B	0	0			0				
A-C	485	121			485				

09:45 - 10:00

Stream	Total Demand (Veh/hr)	Junction Arrivals (Veh)	Capacity (Veh/hr)	RFC	Throughput (Veh/hr)	Start queue (Veh)	End queue (Veh)	Delay (s)	Unsignalised level of service
B-AC	0	0	416	0.000	0	0.0	0.0	0.000	A
C-AB	0	0	1101	0.000	0	0.0	0.0	0.000	A
C-A	612	153			612				
A-B	0	0			0				
A-C	485	121			485				

10:00 - 10:15

Stream	Total Demand (Veh/hr)	Junction Arrivals (Veh)	Capacity (Veh/hr)	RFC	Throughput (Veh/hr)	Start queue (Veh)	End queue (Veh)	Delay (s)	Unsignalised level of service
B-AC	0	0	447	0.000	0	0.0	0.0	0.000	A
C-AB	0	0	1142	0.000	0	0.0	0.0	0.000	A
C-A	500	125			500				
A-B	0	0			0				
A-C	396	99			396				

10:15 - 10:30

Stream	Total Demand (Veh/hr)	Junction Arrivals (Veh)	Capacity (Veh/hr)	RFC	Throughput (Veh/hr)	Start queue (Veh)	End queue (Veh)	Delay (s)	Unsignalised level of service
B-AC	0	0	470	0.000	0	0.0	0.0	0.000	A
C-AB	0	0	1171	0.000	0	0.0	0.0	0.000	A
C-A	419	105			419				
A-B	0	0			0				
A-C	332	83			332				

Queue Variation Results for each time segment

09:00 - 09:15

Stream	Mean (Veh)	Q05 (Veh)	Q50 (Veh)	Q90 (Veh)	Q95 (Veh)	Percentile message	Marker message	Probability of reaching or exceeding marker	Probability of exactly reaching marker
B-AC	0.00	0.00	0.00	0.00	0.00			N/A	N/A
C-AB	0.00	0.00	0.00	0.00	0.00			N/A	N/A

09:15 - 09:30

Stream	Mean (Veh)	Q05 (Veh)	Q50 (Veh)	Q90 (Veh)	Q95 (Veh)	Percentile message	Marker message	Probability of reaching or exceeding marker	Probability of exactly reaching marker
B-AC	0.00	0.00	0.00	0.00	0.00			N/A	N/A
C-AB	0.00	0.00	0.00	0.00	0.00			N/A	N/A

09:30 - 09:45

Stream	Mean (Veh)	Q05 (Veh)	Q50 (Veh)	Q90 (Veh)	Q95 (Veh)	Percentile message	Marker message	Probability of reaching or exceeding marker	Probability of exactly reaching marker
B-AC	0.00	0.00	0.00	0.00	0.00			N/A	N/A
C-AB	0.00	0.00	0.00	0.00	0.00			N/A	N/A

09:45 - 10:00

Stream	Mean (Veh)	Q05 (Veh)	Q50 (Veh)	Q90 (Veh)	Q95 (Veh)	Percentile message	Marker message	Probability of reaching or exceeding marker	Probability of exactly reaching marker
B-AC	0.00	0.00	0.00	0.00	0.00			N/A	N/A
C-AB	0.00	0.00	0.00	0.00	0.00			N/A	N/A

10:00 - 10:15

Stream	Mean (Veh)	Q05 (Veh)	Q50 (Veh)	Q90 (Veh)	Q95 (Veh)	Percentile message	Marker message	Probability of reaching or exceeding marker	Probability of exactly reaching marker
B-AC	0.00	0.00	0.00	0.00	0.00			N/A	N/A
C-AB	0.00	0.00	0.00	0.00	0.00			N/A	N/A

10:15 - 10:30

Stream	Mean (Veh)	Q05 (Veh)	Q50 (Veh)	Q90 (Veh)	Q95 (Veh)	Percentile message	Marker message	Probability of reaching or exceeding marker	Probability of exactly reaching marker
B-AC	0.00	0.00	0.00	0.00	0.00			N/A	N/A
C-AB	0.00	0.00	0.00	0.00	0.00			N/A	N/A

Development Flows, AM

Data Errors and Warnings

Severity	Area	Item	Description
Warning	Demand Set Relationship	D4 - 2027 + Development Flows, AM	Demand Set relationships are chained. This may slow down the file.
Warning	Vehicle Mix		HV% is zero for all movements / time segments. Vehicle Mix matrix should be completed whether working in PCUs or Vehs. If HV% at the junction is genuinely zero, please ignore this warning.
Warning	Queue variations	Analysis Options	Queue percentiles may be unreliable if the mean queue in any time segment is very low or very high.

Junction Network

Junctions

Junction	Name	Junction type	Arm A Direction	Arm B Direction	Arm C Direction	Use circulating lanes	Junction Delay (s)	Junction LOS
1	Development Access	T-Junction	Two-way	Two-way	Two-way		4.61	A

Junction Network

Driving side	Lighting	Network residual capacity (%)	First arm reaching threshold	Network delay (s)	Network LOS
Left	Normal/unknown	900		4.61	A

Traffic Demand

Demand Set Details

ID	Scenario name	Time Period name	Traffic profile type	Start time (HH:mm)	Finish time (HH:mm)	Time segment length (min)	Run automatically
D3	Development Flows	AM	ONE HOUR	09:00	10:30	15	✓

Demand overview (Traffic)

Arm	Linked arm	Profile type	Use O-D data	Average Demand (Veh/hr)	Scaling Factor (%)
A		ONE HOUR	✓	7	100.000
B		ONE HOUR	✓	13	100.000
C		ONE HOUR	✓	12	100.000

Origin-Destination Data

Demand (Veh/hr)

		To		
		A	B	C
From	A	0	7	0
	B	5	0	8
	C	0	12	0

Proportions

		To		
		A	B	C
From	A	0.00	1.00	0.00
	B	0.38	0.00	0.62
	C	0.00	1.00	0.00

Vehicle Mix

HV data entry mode	PCU Factor for a HV (PCU)
HV Percentages	2.00

Heavy Vehicle %

		To		
		A	B	C
From	A	0	0	0
	B	0	0	0
	C	0	0	0

Average PCU Per Veh

		To		
		A	B	C
From	A	1.000	1.000	1.000
	B	1.000	1.000	1.000
	C	1.000	1.000	1.000

Detailed Demand Data

Demand for each time segment

Arm	Time Segment	Demand (Veh/hr)	Demand in PCU (PCU/hr)
A	09:00-09:15	5	5
	09:15-09:30	6	6
	09:30-09:45	8	8
	09:45-10:00	8	8
	10:00-10:15	6	6

	10:15-10:30	5	5
B	09:00-09:15	10	10
	09:15-09:30	12	12
	09:30-09:45	14	14
	09:45-10:00	14	14
	10:00-10:15	12	12
	10:15-10:30	10	10
C	09:00-09:15	9	9
	09:15-09:30	11	11
	09:30-09:45	13	13
	09:45-10:00	13	13
	10:00-10:15	11	11
	10:15-10:30	9	9

Results

Results Summary for whole modelled period

Stream	Max RFC	Max Delay (s)	Max Queue (Veh)	Max 95th percentile Queue (Veh)	Max LOS	Average Demand (Veh/hr)	Total Junction Arrivals (Veh)
B-AC	0.02	6.22	0.0	0.5	A	12	18
C-AB	0.02	5.57	0.0	0.5	A	11	17
C-A						0	0
A-B						6	10
A-C						0	0

Main Results for each time segment

09:00 - 09:15

Stream	Total Demand (Veh/hr)	Junction Arrivals (Veh)	Capacity (Veh/hr)	RFC	Throughput (Veh/hr)	Start queue (Veh)	End queue (Veh)	Delay (s)	Unsignalised level of service
B-AC	10	2	594	0.016	10	0.0	0.0	6.159	A
C-AB	9	2	660	0.014	9	0.0	0.0	5.527	A
C-A	0	0			0				
A-B	5	1			5				
A-C	0	0			0				

09:15 - 09:30

Stream	Total Demand (Veh/hr)	Junction Arrivals (Veh)	Capacity (Veh/hr)	RFC	Throughput (Veh/hr)	Start queue (Veh)	End queue (Veh)	Delay (s)	Unsignalised level of service
B-AC	12	3	594	0.020	12	0.0	0.0	6.183	A
C-AB	11	3	660	0.016	11	0.0	0.0	5.544	A
C-A	0	0			0				
A-B	6	2			6				
A-C	0	0			0				

09:30 - 09:45

Stream	Total Demand (Veh/hr)	Junction Arrivals (Veh)	Capacity (Veh/hr)	RFC	Throughput (Veh/hr)	Start queue (Veh)	End queue (Veh)	Delay (s)	Unsignalised level of service
B-AC	14	4	593	0.024	14	0.0	0.0	6.217	A
C-AB	13	3	660	0.020	13	0.0	0.0	5.567	A
C-A	0	0			0				
A-B	8	2			8				
A-C	0	0			0				

09:45 - 10:00

Stream	Total Demand (Veh/hr)	Junction Arrivals (Veh)	Capacity (Veh/hr)	RFC	Throughput (Veh/hr)	Start queue (Veh)	End queue (Veh)	Delay (s)	Unsignalised level of service
B-AC	14	4	593	0.024	14	0.0	0.0	6.217	A
C-AB	13	3	660	0.020	13	0.0	0.0	5.567	A
C-A	0	0			0				
A-B	8	2			8				
A-C	0	0			0				

10:00 - 10:15

Stream	Total Demand (Veh/hr)	Junction Arrivals (Veh)	Capacity (Veh/hr)	RFC	Throughput (Veh/hr)	Start queue (Veh)	End queue (Veh)	Delay (s)	Unsignalised level of service
B-AC	12	3	594	0.020	12	0.0	0.0	6.184	A
C-AB	11	3	660	0.016	11	0.0	0.0	5.544	A
C-A	0	0			0				
A-B	6	2			6				
A-C	0	0			0				

10:15 - 10:30

Stream	Total Demand (Veh/hr)	Junction Arrivals (Veh)	Capacity (Veh/hr)	RFC	Throughput (Veh/hr)	Start queue (Veh)	End queue (Veh)	Delay (s)	Unsignalised level of service
B-AC	10	2	594	0.016	10	0.0	0.0	6.160	A
C-AB	9	2	660	0.014	9	0.0	0.0	5.529	A
C-A	0	0			0				
A-B	5	1			5				
A-C	0	0			0				

Queue Variation Results for each time segment**09:00 - 09:15**

Stream	Mean (Veh)	Q05 (Veh)	Q50 (Veh)	Q90 (Veh)	Q95 (Veh)	Percentile message	Marker message	Probability of reaching or exceeding marker	Probability of exactly reaching marker
B-AC	0.02	0.00	0.00	0.02	0.02			N/A	N/A
C-AB	0.01	0.00	0.00	0.01	0.01			N/A	N/A

09:15 - 09:30

Stream	Mean (Veh)	Q05 (Veh)	Q50 (Veh)	Q90 (Veh)	Q95 (Veh)	Percentile message	Marker message	Probability of reaching or exceeding marker	Probability of exactly reaching marker
B-AC	0.02	0.02	0.25	0.45	0.48			N/A	N/A
C-AB	0.02	0.02	0.25	0.45	0.48			N/A	N/A

09:30 - 09:45

Stream	Mean (Veh)	Q05 (Veh)	Q50 (Veh)	Q90 (Veh)	Q95 (Veh)	Percentile message	Marker message	Probability of reaching or exceeding marker	Probability of exactly reaching marker
B-AC	0.02	0.00	0.00	0.02	0.02			N/A	N/A
C-AB	0.02	0.00	0.00	0.02	0.02			N/A	N/A

09:45 - 10:00

Stream	Mean (Veh)	Q05 (Veh)	Q50 (Veh)	Q90 (Veh)	Q95 (Veh)	Percentile message	Marker message	Probability of reaching or exceeding marker	Probability of exactly reaching marker
B-AC	0.02	0.00	0.00	0.02	0.02			N/A	N/A
C-AB	0.02	0.00	0.00	0.02	0.02			N/A	N/A

10:00 - 10:15

Stream	Mean (Veh)	Q05 (Veh)	Q50 (Veh)	Q90 (Veh)	Q95 (Veh)	Percentile message	Marker message	Probability of reaching or exceeding marker	Probability of exactly reaching marker
B-AC	0.02	0.00	0.00	0.02	0.02			N/A	N/A
C-AB	0.02	0.00	0.00	0.02	0.02			N/A	N/A

10:15 - 10:30

Stream	Mean (Veh)	Q05 (Veh)	Q50 (Veh)	Q90 (Veh)	Q95 (Veh)	Percentile message	Marker message	Probability of reaching or exceeding marker	Probability of exactly reaching marker
B-AC	0.02	0.00	0.00	0.02	0.02			N/A	N/A
C-AB	0.01	0.00	0.00	0.01	0.01			N/A	N/A

2027 + Development Flows, AM

Data Errors and Warnings

Severity	Area	Item	Description
Warning	Demand Set Relationship	D4 - 2027 + Development Flows, AM	Demand Set relationships are chained. This may slow down the file.
Warning	Vehicle Mix		HV% is zero for all movements / time segments. Vehicle Mix matrix should be completed whether working in PCUs or Vehs. If HV% at the junction is genuinely zero, please ignore this warning.
Warning	Queue variations	Analysis Options	Queue percentiles may be unreliable if the mean queue in any time segment is very low or very high.

Junction Network

Junctions

Junction	Name	Junction type	Arm A Direction	Arm B Direction	Arm C Direction	Use circulating lanes	Junction Delay (s)	Junction LOS
1	Development Access	T-Junction	Two-way	Two-way	Two-way		1.27	A

Junction Network

Driving side	Lighting	Network residual capacity (%)	First arm reaching threshold	Network delay (s)	Network LOS
Left	Normal/unknown	58	Stream B-AC	1.27	A

Traffic Demand

Demand Set Details

ID	Scenario name	Time Period name	Traffic profile type	Start time (HH:mm)	Finish time (HH:mm)	Time segment length (min)	Run automatically	Relationship type	Relationship
D4	2027 + Development Flows	AM	ONE HOUR	09:00	10:30	15	✓	Simple	D2+D3

Demand overview (Traffic)

Arm	Linked arm	Profile type	Use O-D data	Average Demand (Veh/hr)	Scaling Factor (%)
A		ONE HOUR	✓	448	100.000
B		ONE HOUR	✓	13	100.000
C		ONE HOUR	✓	568	100.000

Origin-Destination Data

Demand (Veh/hr)

		To		
		A	B	C
From	A	0	7	441
	B	5	0	8
	C	556	12	0

Proportions

		To		
		A	B	C
From	A	0.00	0.02	0.98
	B	0.38	0.00	0.62
	C	0.98	0.02	0.00

Vehicle Mix

HV data entry mode	PCU Factor for a HV (PCU)
HV Percentages	2.00

Heavy Vehicle %

		To		
		A	B	C
From	A	0	0	0
	B	0	0	0
	C	0	0	0

Average PCU Per Veh

		To		
		A	B	C
From	A	1.000	1.000	1.000
	B	1.000	1.000	1.000
	C	1.000	1.000	1.000

Detailed Demand Data

Demand for each time segment

Arm	Time Segment	Demand (Veh/hr)	Demand in PCU (PCU/hr)
A	09:00-09:15	337	337
	09:15-09:30	402	402
	09:30-09:45	493	493
	09:45-10:00	493	493
	10:00-10:15	402	402

	10:15-10:30	337	337
B	09:00-09:15	10	10
	09:15-09:30	12	12
	09:30-09:45	14	14
	09:45-10:00	14	14
	10:00-10:15	12	12
	10:15-10:30	10	10
C	09:00-09:15	428	428
	09:15-09:30	511	511
	09:30-09:45	625	625
	09:45-10:00	625	625
	10:00-10:15	511	511
	10:15-10:30	428	428

Results

Results Summary for whole modelled period

Stream	Max RFC	Max Delay (s)	Max Queue (Veh)	Max 95th percentile Queue (Veh)	Max LOS	Average Demand (Veh/hr)	Total Junction Arrivals (Veh)
B-AC	0.25	12.75	0.3	1.5	B	79	118
C-AB	0.11	7.57	0.1	0.5	A	51	77
C-A						510	765
A-B						50	74
A-C						404	606

Main Results for each time segment

09:00 - 09:15

Stream	Total Demand (Veh/hr)	Junction Arrivals (Veh)	Capacity (Veh/hr)	RFC	Throughput (Veh/hr)	Start queue (Veh)	End queue (Veh)	Delay (s)	Unsignalised level of service
B-AC	65	16	440	0.147	64	0.0	0.2	9.548	A
C-AB	42	11	576	0.073	42	0.0	0.1	6.731	A
C-A	419	105			419				
A-B	41	10			41				
A-C	332	83			332				

09:15 - 09:30

Stream	Total Demand (Veh/hr)	Junction Arrivals (Veh)	Capacity (Veh/hr)	RFC	Throughput (Veh/hr)	Start queue (Veh)	End queue (Veh)	Delay (s)	Unsignalised level of service
B-AC	77	19	414	0.187	77	0.2	0.2	10.674	B
C-AB	50	13	560	0.090	50	0.1	0.1	7.063	A
C-A	500	125			500				
A-B	49	12			49				
A-C	396	99			396				

09:30 - 09:45

Stream	Total Demand (Veh/hr)	Junction Arrivals (Veh)	Capacity (Veh/hr)	RFC	Throughput (Veh/hr)	Start queue (Veh)	End queue (Veh)	Delay (s)	Unsignalised level of service
B-AC	95	24	377	0.251	94	0.2	0.3	12.710	B
C-AB	62	15	537	0.115	62	0.1	0.1	7.566	A
C-A	612	153			612				
A-B	59	15			59				
A-C	485	121			485				

09:45 - 10:00

Stream	Total Demand (Veh/hr)	Junction Arrivals (Veh)	Capacity (Veh/hr)	RFC	Throughput (Veh/hr)	Start queue (Veh)	End queue (Veh)	Delay (s)	Unsignalised level of service
B-AC	95	24	377	0.251	95	0.3	0.3	12.749	B
C-AB	62	15	537	0.115	62	0.1	0.1	7.569	A
C-A	612	153			612				
A-B	59	15			59				
A-C	485	121			485				

10:00 - 10:15

Stream	Total Demand (Veh/hr)	Junction Arrivals (Veh)	Capacity (Veh/hr)	RFC	Throughput (Veh/hr)	Start queue (Veh)	End queue (Veh)	Delay (s)	Unsignalised level of service
B-AC	77	19	414	0.187	78	0.3	0.2	10.714	B
C-AB	50	13	560	0.090	50	0.1	0.1	7.066	A
C-A	500	125			500				
A-B	49	12			49				
A-C	396	99			396				

10:15 - 10:30

Stream	Total Demand (Veh/hr)	Junction Arrivals (Veh)	Capacity (Veh/hr)	RFC	Throughput (Veh/hr)	Start queue (Veh)	End queue (Veh)	Delay (s)	Unsignalised level of service
B-AC	65	16	440	0.147	65	0.2	0.2	9.596	A
C-AB	42	11	576	0.073	42	0.1	0.1	6.741	A
C-A	419	105			419				
A-B	41	10			41				
A-C	332	83			332				

Queue Variation Results for each time segment**09:00 - 09:15**

Stream	Mean (Veh)	Q05 (Veh)	Q50 (Veh)	Q90 (Veh)	Q95 (Veh)	Percentile message	Marker message	Probability of reaching or exceeding marker	Probability of exactly reaching marker
B-AC	0.17	0.00	0.00	0.17	0.17			N/A	N/A
C-AB	0.08	0.00	0.00	0.08	0.08			N/A	N/A

09:15 - 09:30

Stream	Mean (Veh)	Q05 (Veh)	Q50 (Veh)	Q90 (Veh)	Q95 (Veh)	Percentile message	Marker message	Probability of reaching or exceeding marker	Probability of exactly reaching marker
B-AC	0.23	0.00	0.00	0.23	0.23			N/A	N/A
C-AB	0.10	0.03	0.25	0.45	0.48			N/A	N/A

09:30 - 09:45

Stream	Mean (Veh)	Q05 (Veh)	Q50 (Veh)	Q90 (Veh)	Q95 (Veh)	Percentile message	Marker message	Probability of reaching or exceeding marker	Probability of exactly reaching marker
B-AC	0.33	0.03	0.26	0.46	0.49			N/A	N/A
C-AB	0.13	0.03	0.26	0.47	0.49			N/A	N/A

09:45 - 10:00

Stream	Mean (Veh)	Q05 (Veh)	Q50 (Veh)	Q90 (Veh)	Q95 (Veh)	Percentile message	Marker message	Probability of reaching or exceeding marker	Probability of exactly reaching marker
B-AC	0.33	0.03	0.31	1.16	1.48			N/A	N/A
C-AB	0.13	0.03	0.25	0.45	0.48			N/A	N/A

10:00 - 10:15

Stream	Mean (Veh)	Q05 (Veh)	Q50 (Veh)	Q90 (Veh)	Q95 (Veh)	Percentile message	Marker message	Probability of reaching or exceeding marker	Probability of exactly reaching marker
B-AC	0.23	0.00	0.00	0.23	0.23			N/A	N/A
C-AB	0.10	0.00	0.00	0.10	0.10			N/A	N/A

10:15 - 10:30

Stream	Mean (Veh)	Q05 (Veh)	Q50 (Veh)	Q90 (Veh)	Q95 (Veh)	Percentile message	Marker message	Probability of reaching or exceeding marker	Probability of exactly reaching marker
B-AC	0.17	0.00	0.00	0.17	0.17			N/A	N/A
C-AB	0.08	0.00	0.00	0.08	0.08			N/A	N/A

2032 Faactored Base + 5yrs, AM

Data Errors and Warnings

Severity	Area	Item	Description
Warning	Demand Set Relationship	D4 - 2027 + Development Flows, AM	Demand Set relationships are chained. This may slow down the file.
Warning	Vehicle Mix		HV% is zero for all movements / time segments. Vehicle Mix matrix should be completed whether working in PCUs or Vehs. If HV% at the junction is genuinely zero, please ignore this warning.
Warning	Queue variations	Analysis Options	Queue percentiles may be unreliable if the mean queue in any time segment is very low or very high.

Junction Network

Junctions

Junction	Name	Junction type	Arm A Direction	Arm B Direction	Arm C Direction	Use circulating lanes	Junction Delay (s)	Junction LOS
1	Development Access	T-Junction	Two-way	Two-way	Two-way		0.00	A

Junction Network

Driving side	Lighting	Network residual capacity (%)	First arm reaching threshold	Network delay (s)	Network LOS
Left	Normal/unknown	900		0.00	A

Traffic Demand

Demand Set Details

ID	Scenario name	Time Period name	Traffic profile type	Start time (HH:mm)	Finish time (HH:mm)	Time segment length (min)	Run automatically	Relationship type	Relationship
D5	2032 Faactored Base + 5yrs	AM	ONE HOUR	09:00	10:30	15	✓	Simple	D1*G2

Demand overview (Traffic)

Arm	Linked arm	Profile type	Use O-D data	Average Demand (Veh/hr)	Scaling Factor (%)
A		ONE HOUR	✓	455	100.000
B		ONE HOUR	✓	0	100.000
C		ONE HOUR	✓	574	100.000

Origin-Destination Data

Demand (Veh/hr)

	To			
	A	B	C	
From	A	0	0	455
	B	0	0	0
	C	574	0	0

Proportions

	To			
	A	B	C	
From	A	0.00	0.00	1.00
	B	0.33	0.33	0.33
	C	1.00	0.00	0.00

Vehicle Mix

HV data entry mode	PCU Factor for a HV (PCU)
HV Percentages	2.00

Heavy Vehicle %

	To			
	A	B	C	
From	A	0	0	0
	B	0	0	0
	C	0	0	0

Average PCU Per Veh

	To			
	A	B	C	
From	A	1.000	1.000	1.000
	B	1.000	1.000	1.000
	C	1.000	1.000	1.000

Detailed Demand Data

Demand for each time segment

Arm	Time Segment	Demand (Veh/hr)	Demand in PCU (PCU/hr)
A	09:00-09:15	342	342
	09:15-09:30	409	409
	09:30-09:45	501	501
	09:45-10:00	501	501
	10:00-10:15	409	409

	10:15-10:30	342	342
B	09:00-09:15	0	0
	09:15-09:30	0	0
	09:30-09:45	0	0
	09:45-10:00	0	0
	10:00-10:15	0	0
	10:15-10:30	0	0
C	09:00-09:15	432	432
	09:15-09:30	516	516
	09:30-09:45	632	632
	09:45-10:00	632	632
	10:00-10:15	516	516
	10:15-10:30	432	432

Results

Results Summary for whole modelled period

Stream	Max RFC	Max Delay (s)	Max Queue (Veh)	Max 95th percentile Queue (Veh)	Max LOS	Average Demand (Veh/hr)	Total Junction Arrivals (Veh)
B-AC	0.00	0.00	0.0	~1	A	0	0
C-AB	0.00	0.00	0.0	~1	A	0	0
C-A						527	790
A-B						0	0
A-C						417	626

Main Results for each time segment

09:00 - 09:15

Stream	Total Demand (Veh/hr)	Junction Arrivals (Veh)	Capacity (Veh/hr)	RFC	Throughput (Veh/hr)	Start queue (Veh)	End queue (Veh)	Delay (s)	Unsignalised level of service
B-AC	0	0	466	0.000	0	0.0	0.0	0.000	A
C-AB	0	0	1167	0.000	0	0.0	0.0	0.000	A
C-A	432	108			432				
A-B	0	0			0				
A-C	342	86			342				

09:15 - 09:30

Stream	Total Demand (Veh/hr)	Junction Arrivals (Veh)	Capacity (Veh/hr)	RFC	Throughput (Veh/hr)	Start queue (Veh)	End queue (Veh)	Delay (s)	Unsignalised level of service
B-AC	0	0	443	0.000	0	0.0	0.0	0.000	A
C-AB	0	0	1136	0.000	0	0.0	0.0	0.000	A
C-A	516	129			516				
A-B	0	0			0				
A-C	409	102			409				

09:30 - 09:45

Stream	Total Demand (Veh/hr)	Junction Arrivals (Veh)	Capacity (Veh/hr)	RFC	Throughput (Veh/hr)	Start queue (Veh)	End queue (Veh)	Delay (s)	Unsignalised level of service
B-AC	0	0	410	0.000	0	0.0	0.0	0.000	A
C-AB	0	0	1094	0.000	0	0.0	0.0	0.000	A
C-A	632	158			632				
A-B	0	0			0				
A-C	501	125			501				

09:45 - 10:00

Stream	Total Demand (Veh/hr)	Junction Arrivals (Veh)	Capacity (Veh/hr)	RFC	Throughput (Veh/hr)	Start queue (Veh)	End queue (Veh)	Delay (s)	Unsignalised level of service
B-AC	0	0	410	0.000	0	0.0	0.0	0.000	A
C-AB	0	0	1094	0.000	0	0.0	0.0	0.000	A
C-A	632	158			632				
A-B	0	0			0				
A-C	501	125			501				

10:00 - 10:15

Stream	Total Demand (Veh/hr)	Junction Arrivals (Veh)	Capacity (Veh/hr)	RFC	Throughput (Veh/hr)	Start queue (Veh)	End queue (Veh)	Delay (s)	Unsignalised level of service
B-AC	0	0	443	0.000	0	0.0	0.0	0.000	A
C-AB	0	0	1136	0.000	0	0.0	0.0	0.000	A
C-A	516	129			516				
A-B	0	0			0				
A-C	409	102			409				

10:15 - 10:30

Stream	Total Demand (Veh/hr)	Junction Arrivals (Veh)	Capacity (Veh/hr)	RFC	Throughput (Veh/hr)	Start queue (Veh)	End queue (Veh)	Delay (s)	Unsignalised level of service
B-AC	0	0	466	0.000	0	0.0	0.0	0.000	A
C-AB	0	0	1167	0.000	0	0.0	0.0	0.000	A
C-A	432	108			432				
A-B	0	0			0				
A-C	342	86			342				

Queue Variation Results for each time segment

09:00 - 09:15

Stream	Mean (Veh)	Q05 (Veh)	Q50 (Veh)	Q90 (Veh)	Q95 (Veh)	Percentile message	Marker message	Probability of reaching or exceeding marker	Probability of exactly reaching marker
B-AC	0.00	0.00	0.00	0.00	0.00			N/A	N/A
C-AB	0.00	0.00	0.00	0.00	0.00			N/A	N/A

09:15 - 09:30

Stream	Mean (Veh)	Q05 (Veh)	Q50 (Veh)	Q90 (Veh)	Q95 (Veh)	Percentile message	Marker message	Probability of reaching or exceeding marker	Probability of exactly reaching marker
B-AC	0.00	0.00	0.00	0.00	0.00			N/A	N/A
C-AB	0.00	0.00	0.00	0.00	0.00			N/A	N/A

09:30 - 09:45

Stream	Mean (Veh)	Q05 (Veh)	Q50 (Veh)	Q90 (Veh)	Q95 (Veh)	Percentile message	Marker message	Probability of reaching or exceeding marker	Probability of exactly reaching marker
B-AC	0.00	0.00	0.00	0.00	0.00			N/A	N/A
C-AB	0.00	0.00	0.00	0.00	0.00			N/A	N/A

09:45 - 10:00

Stream	Mean (Veh)	Q05 (Veh)	Q50 (Veh)	Q90 (Veh)	Q95 (Veh)	Percentile message	Marker message	Probability of reaching or exceeding marker	Probability of exactly reaching marker
B-AC	0.00	0.00	0.00	0.00	0.00			N/A	N/A
C-AB	0.00	0.00	0.00	0.00	0.00			N/A	N/A

10:00 - 10:15

Stream	Mean (Veh)	Q05 (Veh)	Q50 (Veh)	Q90 (Veh)	Q95 (Veh)	Percentile message	Marker message	Probability of reaching or exceeding marker	Probability of exactly reaching marker
B-AC	0.00	0.00	0.00	0.00	0.00			N/A	N/A
C-AB	0.00	0.00	0.00	0.00	0.00			N/A	N/A

10:15 - 10:30

Stream	Mean (Veh)	Q05 (Veh)	Q50 (Veh)	Q90 (Veh)	Q95 (Veh)	Percentile message	Marker message	Probability of reaching or exceeding marker	Probability of exactly reaching marker
B-AC	0.00	0.00	0.00	0.00	0.00			N/A	N/A
C-AB	0.00	0.00	0.00	0.00	0.00			N/A	N/A

2032 Faactored Base + Dev Flows = +5yrs, AM

Data Errors and Warnings

Severity	Area	Item	Description
Warning	Demand Set Relationship	D4 - 2027 + Development Flows, AM	Demand Set relationships are chained. This may slow down the file.
Warning	Vehicle Mix		HV% is zero for all movements / time segments. Vehicle Mix matrix should be completed whether working in PCUs or Vehs. If HV% at the junction is genuinely zero, please ignore this warning.
Warning	Queue variations	Analysis Options	Queue percentiles may be unreliable if the mean queue in any time segment is very low or very high.

Junction Network

Junctions

Junction	Name	Junction type	Arm A Direction	Arm B Direction	Arm C Direction	Use circulating lanes	Junction Delay (s)	Junction LOS
1	Development Access	T-Junction	Two-way	Two-way	Two-way		1.26	A

Junction Network

Driving side	Lighting	Network residual capacity (%)	First arm reaching threshold	Network delay (s)	Network LOS
Left	Normal/unknown	55	Stream B-AC	1.26	A

Traffic Demand

Demand Set Details

ID	Scenario name	Time Period name	Traffic profile type	Start time (HH:mm)	Finish time (HH:mm)	Time segment length (min)	Run automatically	Relationship type	Relationship
D6	2032 Faactored Base + Dev Flows = +5yrs	AM	ONE HOUR	09:00	10:30	15	✓	Simple	D3+D5

Demand overview (Traffic)

Arm	Linked arm	Profile type	Use O-D data	Average Demand (Veh/hr)	Scaling Factor (%)
A		ONE HOUR	✓	462	100.000
B		ONE HOUR	✓	13	100.000
C		ONE HOUR	✓	586	100.000

Origin-Destination Data

Demand (Veh/hr)

		To		
		A	B	C
From	A	0	7	455
	B	5	0	8
	C	574	12	0

Proportions

		To		
		A	B	C
From	A	0.00	0.02	0.98
	B	0.38	0.00	0.62
	C	0.98	0.02	0.00

Vehicle Mix

HV data entry mode	PCU Factor for a HV (PCU)
HV Percentages	2.00

Heavy Vehicle %

		To		
		A	B	C
From	A	0	0	0
	B	0	0	0
	C	0	0	0

Average PCU Per Veh

		To		
		A	B	C
From	A	1.000	1.000	1.000
	B	1.000	1.000	1.000
	C	1.000	1.000	1.000

Detailed Demand Data

Demand for each time segment

Arm	Time Segment	Demand (Veh/hr)	Demand in PCU (PCU/hr)
A	09:00-09:15	348	348
	09:15-09:30	415	415
	09:30-09:45	509	509

	09:45-10:00	509	509
	10:00-10:15	415	415
	10:15-10:30	348	348
B	09:00-09:15	10	10
	09:15-09:30	12	12
	09:30-09:45	14	14
	09:45-10:00	14	14
	10:00-10:15	12	12
	10:15-10:30	10	10
C	09:00-09:15	441	441
	09:15-09:30	527	527
	09:30-09:45	645	645
	09:45-10:00	645	645
	10:00-10:15	527	527
	10:15-10:30	441	441

Results

Results Summary for whole modelled period

Stream	Max RFC	Max Delay (s)	Max Queue (Veh)	Max 95th percentile Queue (Veh)	Max LOS	Average Demand (Veh/hr)	Total Junction Arrivals (Veh)
B-AC	0.26	13.02	0.3	1.0	B	79	118
C-AB	0.12	7.63	0.1	0.5	A	51	77
C-A						527	790
A-B						50	74
A-C						417	626

Main Results for each time segment

09:00 - 09:15

Stream	Total Demand (Veh/hr)	Junction Arrivals (Veh)	Capacity (Veh/hr)	RFC	Throughput (Veh/hr)	Start queue (Veh)	End queue (Veh)	Delay (s)	Unsignalised level of service
B-AC	65	16	437	0.148	64	0.0	0.2	9.648	A
C-AB	42	11	574	0.073	42	0.0	0.1	6.760	A
C-A	432	108			432				
A-B	41	10			41				
A-C	342	86			342				

09:15 - 09:30

Stream	Total Demand (Veh/hr)	Junction Arrivals (Veh)	Capacity (Veh/hr)	RFC	Throughput (Veh/hr)	Start queue (Veh)	End queue (Veh)	Delay (s)	Unsignalised level of service
B-AC	77	19	409	0.189	77	0.2	0.2	10.824	B
C-AB	50	13	557	0.090	50	0.1	0.1	7.104	A
C-A	516	129			516				
A-B	49	12			49				
A-C	409	102			409				

09:30 - 09:45

Stream	Total Demand (Veh/hr)	Junction Arrivals (Veh)	Capacity (Veh/hr)	RFC	Throughput (Veh/hr)	Start queue (Veh)	End queue (Veh)	Delay (s)	Unsignalised level of service
B-AC	95	24	371	0.255	94	0.2	0.3	12.962	B
C-AB	62	15	534	0.116	62	0.1	0.1	7.624	A
C-A	632	158			632				
A-B	59	15			59				
A-C	501	125			501				

09:45 - 10:00

Stream	Total Demand (Veh/hr)	Junction Arrivals (Veh)	Capacity (Veh/hr)	RFC	Throughput (Veh/hr)	Start queue (Veh)	End queue (Veh)	Delay (s)	Unsignalised level of service
B-AC	95	24	371	0.255	95	0.3	0.3	13.023	B
C-AB	62	15	534	0.116	62	0.1	0.1	7.627	A
C-A	632	158			632				
A-B	59	15			59				
A-C	501	125			501				

10:00 - 10:15

Stream	Total Demand (Veh/hr)	Junction Arrivals (Veh)	Capacity (Veh/hr)	RFC	Throughput (Veh/hr)	Start queue (Veh)	End queue (Veh)	Delay (s)	Unsignalised level of service
B-AC	77	19	409	0.189	78	0.3	0.2	10.870	B
C-AB	50	13	557	0.090	50	0.1	0.1	7.110	A
C-A	516	129			516				

A-B	49	12			49				
A-C	409	102			409				

10:15 - 10:30

Stream	Total Demand (Veh/hr)	Junction Arrivals (Veh)	Capacity (Veh/hr)	RFC	Throughput (Veh/hr)	Start queue (Veh)	End queue (Veh)	Delay (s)	Unsignalised level of service
B-AC	65	16	436	0.148	65	0.2	0.2	9.699	A
C-AB	42	11	574	0.073	42	0.1	0.1	6.770	A
C-A	432	108			432				
A-B	41	10			41				
A-C	342	86			342				

Queue Variation Results for each time segment**09:00 - 09:15**

Stream	Mean (Veh)	Q05 (Veh)	Q50 (Veh)	Q90 (Veh)	Q95 (Veh)	Percentile message	Marker message	Probability of reaching or exceeding marker	Probability of exactly reaching marker
B-AC	0.17	0.00	0.00	0.17	0.17			N/A	N/A
C-AB	0.08	0.00	0.00	0.08	0.08			N/A	N/A

09:15 - 09:30

Stream	Mean (Veh)	Q05 (Veh)	Q50 (Veh)	Q90 (Veh)	Q95 (Veh)	Percentile message	Marker message	Probability of reaching or exceeding marker	Probability of exactly reaching marker
B-AC	0.23	0.00	0.00	0.23	0.23			N/A	N/A
C-AB	0.10	0.03	0.25	0.45	0.48			N/A	N/A

09:30 - 09:45

Stream	Mean (Veh)	Q05 (Veh)	Q50 (Veh)	Q90 (Veh)	Q95 (Veh)	Percentile message	Marker message	Probability of reaching or exceeding marker	Probability of exactly reaching marker
B-AC	0.34	0.03	0.26	0.46	0.49			N/A	N/A
C-AB	0.13	0.03	0.26	0.47	0.49			N/A	N/A

09:45 - 10:00

Stream	Mean (Veh)	Q05 (Veh)	Q50 (Veh)	Q90 (Veh)	Q95 (Veh)	Percentile message	Marker message	Probability of reaching or exceeding marker	Probability of exactly reaching marker
B-AC	0.34	0.03	0.31	1.02	1.02			N/A	N/A
C-AB	0.13	0.03	0.25	0.45	0.48			N/A	N/A

10:00 - 10:15

Stream	Mean (Veh)	Q05 (Veh)	Q50 (Veh)	Q90 (Veh)	Q95 (Veh)	Percentile message	Marker message	Probability of reaching or exceeding marker	Probability of exactly reaching marker
B-AC	0.24	0.00	0.00	0.24	0.24			N/A	N/A
C-AB	0.10	0.00	0.00	0.10	0.10			N/A	N/A

10:15 - 10:30

Stream	Mean (Veh)	Q05 (Veh)	Q50 (Veh)	Q90 (Veh)	Q95 (Veh)	Percentile message	Marker message	Probability of reaching or exceeding marker	Probability of exactly reaching marker
B-AC	0.18	0.00	0.00	0.18	0.18			N/A	N/A
C-AB	0.08	0.00	0.00	0.08	0.08			N/A	N/A

2042 Faactored Base + 15yrs, AM

Data Errors and Warnings

Severity	Area	Item	Description
Warning	Demand Set Relationship	D4 - 2027 + Development Flows, AM	Demand Set relationships are chained. This may slow down the file.
Warning	Vehicle Mix		HV% is zero for all movements / time segments. Vehicle Mix matrix should be completed whether working in PCUs or Vehs. If HV% at the junction is genuinely zero, please ignore this warning.
Warning	Queue variations	Analysis Options	Queue percentiles may be unreliable if the mean queue in any time segment is very low or very high.

Junction Network

Junctions

Junction	Name	Junction type	Arm A Direction	Arm B Direction	Arm C Direction	Use circulating lanes	Junction Delay (s)	Junction LOS
1	Development Access	T-Junction	Two-way	Two-way	Two-way		0.00	A

Junction Network

Driving side	Lighting	Network residual capacity (%)	First arm reaching threshold	Network delay (s)	Network LOS
Left	Normal/unknown	900		0.00	A

Traffic Demand

Demand Set Details

ID	Scenario name	Time Period name	Traffic profile type	Start time (HH:mm)	Finish time (HH:mm)	Time segment length (min)	Run automatically	Relationship type	Relationship
D7	2042 Faactored Base + 15yrs	AM	ONE HOUR	09:00	10:30	15	✓	Simple	D1*G3

Demand overview (Traffic)

Arm	Linked arm	Profile type	Use O-D data	Average Demand (Veh/hr)	Scaling Factor (%)
A		ONE HOUR	✓	464	100.000
B		ONE HOUR	✓	0	100.000
C		ONE HOUR	✓	585	100.000

Origin-Destination Data

Demand (Veh/hr)

	To			
	A	B	C	
From	A	0	0	464
	B	0	0	0
	C	585	0	0

Proportions

	To			
	A	B	C	
From	A	0.00	0.00	1.00
	B	0.33	0.33	0.33
	C	1.00	0.00	0.00

Vehicle Mix

HV data entry mode	PCU Factor for a HV (PCU)
HV Percentages	2.00

Heavy Vehicle %

	To			
	A	B	C	
From	A	0	0	0
	B	0	0	0
	C	0	0	0

Average PCU Per Veh

	To			
	A	B	C	
From	A	1.000	1.000	1.000
	B	1.000	1.000	1.000
	C	1.000	1.000	1.000

Detailed Demand Data

Demand for each time segment

Arm	Time Segment	Demand (Veh/hr)	Demand in PCU (PCU/hr)
A	09:00-09:15	349	349
	09:15-09:30	417	417
	09:30-09:45	511	511
	09:45-10:00	511	511
	10:00-10:15	417	417

	10:15-10:30	349	349
B	09:00-09:15	0	0
	09:15-09:30	0	0
	09:30-09:45	0	0
	09:45-10:00	0	0
	10:00-10:15	0	0
	10:15-10:30	0	0
C	09:00-09:15	441	441
	09:15-09:30	526	526
	09:30-09:45	644	644
	09:45-10:00	644	644
	10:00-10:15	526	526
	10:15-10:30	441	441

Results

Results Summary for whole modelled period

Stream	Max RFC	Max Delay (s)	Max Queue (Veh)	Max 95th percentile Queue (Veh)	Max LOS	Average Demand (Veh/hr)	Total Junction Arrivals (Veh)
B-AC	0.00	0.00	0.0	~1	A	0	0
C-AB	0.00	0.00	0.0	~1	A	0	0
C-A						537	806
A-B						0	0
A-C						426	638

Main Results for each time segment

09:00 - 09:15

Stream	Total Demand (Veh/hr)	Junction Arrivals (Veh)	Capacity (Veh/hr)	RFC	Throughput (Veh/hr)	Start queue (Veh)	End queue (Veh)	Delay (s)	Unsignalised level of service
B-AC	0	0	464	0.000	0	0.0	0.0	0.000	A
C-AB	0	0	1163	0.000	0	0.0	0.0	0.000	A
C-A	441	110			441				
A-B	0	0			0				
A-C	349	87			349				

09:15 - 09:30

Stream	Total Demand (Veh/hr)	Junction Arrivals (Veh)	Capacity (Veh/hr)	RFC	Throughput (Veh/hr)	Start queue (Veh)	End queue (Veh)	Delay (s)	Unsignalised level of service
B-AC	0	0	440	0.000	0	0.0	0.0	0.000	A
C-AB	0	0	1132	0.000	0	0.0	0.0	0.000	A
C-A	526	132			526				
A-B	0	0			0				
A-C	417	104			417				

09:30 - 09:45

Stream	Total Demand (Veh/hr)	Junction Arrivals (Veh)	Capacity (Veh/hr)	RFC	Throughput (Veh/hr)	Start queue (Veh)	End queue (Veh)	Delay (s)	Unsignalised level of service
B-AC	0	0	407	0.000	0	0.0	0.0	0.000	A
C-AB	0	0	1090	0.000	0	0.0	0.0	0.000	A
C-A	644	161			644				
A-B	0	0			0				
A-C	511	128			511				

09:45 - 10:00

Stream	Total Demand (Veh/hr)	Junction Arrivals (Veh)	Capacity (Veh/hr)	RFC	Throughput (Veh/hr)	Start queue (Veh)	End queue (Veh)	Delay (s)	Unsignalised level of service
B-AC	0	0	407	0.000	0	0.0	0.0	0.000	A
C-AB	0	0	1090	0.000	0	0.0	0.0	0.000	A
C-A	644	161			644				
A-B	0	0			0				
A-C	511	128			511				

10:00 - 10:15

Stream	Total Demand (Veh/hr)	Junction Arrivals (Veh)	Capacity (Veh/hr)	RFC	Throughput (Veh/hr)	Start queue (Veh)	End queue (Veh)	Delay (s)	Unsignalised level of service
B-AC	0	0	440	0.000	0	0.0	0.0	0.000	A
C-AB	0	0	1132	0.000	0	0.0	0.0	0.000	A
C-A	526	132			526				
A-B	0	0			0				
A-C	417	104			417				

10:15 - 10:30

Stream	Total Demand (Veh/hr)	Junction Arrivals (Veh)	Capacity (Veh/hr)	RFC	Throughput (Veh/hr)	Start queue (Veh)	End queue (Veh)	Delay (s)	Unsignalised level of service
B-AC	0	0	464	0.000	0	0.0	0.0	0.000	A
C-AB	0	0	1163	0.000	0	0.0	0.0	0.000	A
C-A	441	110			441				
A-B	0	0			0				
A-C	349	87			349				

Queue Variation Results for each time segment

09:00 - 09:15

Stream	Mean (Veh)	Q05 (Veh)	Q50 (Veh)	Q90 (Veh)	Q95 (Veh)	Percentile message	Marker message	Probability of reaching or exceeding marker	Probability of exactly reaching marker
B-AC	0.00	0.00	0.00	0.00	0.00			N/A	N/A
C-AB	0.00	0.00	0.00	0.00	0.00			N/A	N/A

09:15 - 09:30

Stream	Mean (Veh)	Q05 (Veh)	Q50 (Veh)	Q90 (Veh)	Q95 (Veh)	Percentile message	Marker message	Probability of reaching or exceeding marker	Probability of exactly reaching marker
B-AC	0.00	0.00	0.00	0.00	0.00			N/A	N/A
C-AB	0.00	0.00	0.00	0.00	0.00			N/A	N/A

09:30 - 09:45

Stream	Mean (Veh)	Q05 (Veh)	Q50 (Veh)	Q90 (Veh)	Q95 (Veh)	Percentile message	Marker message	Probability of reaching or exceeding marker	Probability of exactly reaching marker
B-AC	0.00	0.00	0.00	0.00	0.00			N/A	N/A
C-AB	0.00	0.00	0.00	0.00	0.00			N/A	N/A

09:45 - 10:00

Stream	Mean (Veh)	Q05 (Veh)	Q50 (Veh)	Q90 (Veh)	Q95 (Veh)	Percentile message	Marker message	Probability of reaching or exceeding marker	Probability of exactly reaching marker
B-AC	0.00	0.00	0.00	0.00	0.00			N/A	N/A
C-AB	0.00	0.00	0.00	0.00	0.00			N/A	N/A

10:00 - 10:15

Stream	Mean (Veh)	Q05 (Veh)	Q50 (Veh)	Q90 (Veh)	Q95 (Veh)	Percentile message	Marker message	Probability of reaching or exceeding marker	Probability of exactly reaching marker
B-AC	0.00	0.00	0.00	0.00	0.00			N/A	N/A
C-AB	0.00	0.00	0.00	0.00	0.00			N/A	N/A

10:15 - 10:30

Stream	Mean (Veh)	Q05 (Veh)	Q50 (Veh)	Q90 (Veh)	Q95 (Veh)	Percentile message	Marker message	Probability of reaching or exceeding marker	Probability of exactly reaching marker
B-AC	0.00	0.00	0.00	0.00	0.00			N/A	N/A
C-AB	0.00	0.00	0.00	0.00	0.00			N/A	N/A

2042 Faactored Base + 15yrs + Dev Flows, AM

Data Errors and Warnings

Severity	Area	Item	Description
Warning	Demand Set Relationship	D4 - 2027 + Development Flows, AM	Demand Set relationships are chained. This may slow down the file.
Warning	Vehicle Mix		HV% is zero for all movements / time segments. Vehicle Mix matrix should be completed whether working in PCUs or Vehs. If HV% at the junction is genuinely zero, please ignore this warning.
Warning	Queue variations	Analysis Options	Queue percentiles may be unreliable if the mean queue in any time segment is very low or very high.

Junction Network

Junctions

Junction	Name	Junction type	Arm A Direction	Arm B Direction	Arm C Direction	Use circulating lanes	Junction Delay (s)	Junction LOS
1	Development Access	T-Junction	Two-way	Two-way	Two-way		1.26	A

Junction Network

Driving side	Lighting	Network residual capacity (%)	First arm reaching threshold	Network delay (s)	Network LOS
Left	Normal/unknown	53	Stream B-AC	1.26	A

Traffic Demand

Demand Set Details

ID	Scenario name	Time Period name	Traffic profile type	Start time (HH:mm)	Finish time (HH:mm)	Time segment length (min)	Run automatically	Relationship type	Relationship
D8	2042 Faactored Base + 15yrs + Dev Flows	AM	ONE HOUR	09:00	10:30	15	✓	Simple	D3+D7

Demand overview (Traffic)

Arm	Linked arm	Profile type	Use O-D data	Average Demand (Veh/hr)	Scaling Factor (%)
A		ONE HOUR	✓	471	100.000
B		ONE HOUR	✓	13	100.000
C		ONE HOUR	✓	597	100.000

Origin-Destination Data

Demand (Veh/hr)

		To		
		A	B	C
From	A	0	7	464
	B	5	0	8
	C	585	12	0

Proportions

		To		
		A	B	C
From	A	0.00	0.01	0.99
	B	0.38	0.00	0.62
	C	0.98	0.02	0.00

Vehicle Mix

HV data entry mode	PCU Factor for a HV (PCU)
HV Percentages	2.00

Heavy Vehicle %

		To		
		A	B	C
From	A	0	0	0
	B	0	0	0
	C	0	0	0

Average PCU Per Veh

		To		
		A	B	C
From	A	1.000	1.000	1.000
	B	1.000	1.000	1.000
	C	1.000	1.000	1.000

Detailed Demand Data

Demand for each time segment

Arm	Time Segment	Demand (Veh/hr)	Demand in PCU (PCU/hr)
A	09:00-09:15	354	354
	09:15-09:30	423	423
	09:30-09:45	518	518

	09:45-10:00	518	518
	10:00-10:15	423	423
	10:15-10:30	354	354
B	09:00-09:15	10	10
	09:15-09:30	12	12
	09:30-09:45	14	14
	09:45-10:00	14	14
	10:00-10:15	12	12
	10:15-10:30	10	10
C	09:00-09:15	450	450
	09:15-09:30	537	537
	09:30-09:45	658	658
	09:45-10:00	658	658
	10:00-10:15	537	537
	10:15-10:30	450	450

Results

Results Summary for whole modelled period

Stream	Max RFC	Max Delay (s)	Max Queue (Veh)	Max 95th percentile Queue (Veh)	Max LOS	Average Demand (Veh/hr)	Total Junction Arrivals (Veh)
B-AC	0.26	13.20	0.3	1.1	B	79	118
C-AB	0.12	7.66	0.1	0.5	A	51	77
C-A						537	806
A-B						50	74
A-C						426	638

Main Results for each time segment

09:00 - 09:15

Stream	Total Demand (Veh/hr)	Junction Arrivals (Veh)	Capacity (Veh/hr)	RFC	Throughput (Veh/hr)	Start queue (Veh)	End queue (Veh)	Delay (s)	Unsignalised level of service
B-AC	65	16	434	0.149	64	0.0	0.2	9.712	A
C-AB	42	11	572	0.074	42	0.0	0.1	6.780	A
C-A	441	110			441				
A-B	41	10			41				
A-C	349	87			349				

09:15 - 09:30

Stream	Total Demand (Veh/hr)	Junction Arrivals (Veh)	Capacity (Veh/hr)	RFC	Throughput (Veh/hr)	Start queue (Veh)	End queue (Veh)	Delay (s)	Unsignalised level of service
B-AC	77	19	406	0.190	77	0.2	0.2	10.922	B
C-AB	50	13	555	0.091	50	0.1	0.1	7.130	A
C-A	526	132			526				
A-B	49	12			49				
A-C	417	104			417				

09:30 - 09:45

Stream	Total Demand (Veh/hr)	Junction Arrivals (Veh)	Capacity (Veh/hr)	RFC	Throughput (Veh/hr)	Start queue (Veh)	End queue (Veh)	Delay (s)	Unsignalised level of service
B-AC	95	24	367	0.258	94	0.2	0.3	13.160	B
C-AB	62	15	531	0.116	62	0.1	0.1	7.660	A
C-A	644	161			644				
A-B	59	15			59				
A-C	511	128			511				

09:45 - 10:00

Stream	Total Demand (Veh/hr)	Junction Arrivals (Veh)	Capacity (Veh/hr)	RFC	Throughput (Veh/hr)	Start queue (Veh)	End queue (Veh)	Delay (s)	Unsignalised level of service
B-AC	95	24	367	0.258	95	0.3	0.3	13.202	B
C-AB	62	15	531	0.116	62	0.1	0.1	7.663	A
C-A	644	161			644				
A-B	59	15			59				
A-C	511	128			511				

10:00 - 10:15

Stream	Total Demand (Veh/hr)	Junction Arrivals (Veh)	Capacity (Veh/hr)	RFC	Throughput (Veh/hr)	Start queue (Veh)	End queue (Veh)	Delay (s)	Unsignalised level of service
B-AC	77	19	406	0.190	78	0.3	0.2	10.967	B
C-AB	50	13	555	0.091	50	0.1	0.1	7.133	A
C-A	526	132			526				

A-B	49	12			49				
A-C	417	104			417				

10:15 - 10:30

Stream	Total Demand (Veh/hr)	Junction Arrivals (Veh)	Capacity (Veh/hr)	RFC	Throughput (Veh/hr)	Start queue (Veh)	End queue (Veh)	Delay (s)	Unsignalised level of service
B-AC	65	16	434	0.149	65	0.2	0.2	9.762	A
C-AB	42	11	572	0.074	42	0.1	0.1	6.790	A
C-A	441	110			441				
A-B	41	10			41				
A-C	349	87			349				

Queue Variation Results for each time segment**09:00 - 09:15**

Stream	Mean (Veh)	Q05 (Veh)	Q50 (Veh)	Q90 (Veh)	Q95 (Veh)	Percentile message	Marker message	Probability of reaching or exceeding marker	Probability of exactly reaching marker
B-AC	0.17	0.00	0.00	0.17	0.17			N/A	N/A
C-AB	0.08	0.00	0.00	0.08	0.08			N/A	N/A

09:15 - 09:30

Stream	Mean (Veh)	Q05 (Veh)	Q50 (Veh)	Q90 (Veh)	Q95 (Veh)	Percentile message	Marker message	Probability of reaching or exceeding marker	Probability of exactly reaching marker
B-AC	0.23	0.00	0.00	0.23	0.23			N/A	N/A
C-AB	0.10	0.03	0.25	0.45	0.48			N/A	N/A

09:30 - 09:45

Stream	Mean (Veh)	Q05 (Veh)	Q50 (Veh)	Q90 (Veh)	Q95 (Veh)	Percentile message	Marker message	Probability of reaching or exceeding marker	Probability of exactly reaching marker
B-AC	0.34	0.03	0.26	0.46	0.49			N/A	N/A
C-AB	0.13	0.03	0.26	0.47	0.49			N/A	N/A

09:45 - 10:00

Stream	Mean (Veh)	Q05 (Veh)	Q50 (Veh)	Q90 (Veh)	Q95 (Veh)	Percentile message	Marker message	Probability of reaching or exceeding marker	Probability of exactly reaching marker
B-AC	0.34	0.03	0.31	1.08	1.08			N/A	N/A
C-AB	0.13	0.03	0.25	0.45	0.48			N/A	N/A

10:00 - 10:15

Stream	Mean (Veh)	Q05 (Veh)	Q50 (Veh)	Q90 (Veh)	Q95 (Veh)	Percentile message	Marker message	Probability of reaching or exceeding marker	Probability of exactly reaching marker
B-AC	0.24	0.00	0.00	0.24	0.24			N/A	N/A
C-AB	0.10	0.00	0.00	0.10	0.10			N/A	N/A

10:15 - 10:30

Stream	Mean (Veh)	Q05 (Veh)	Q50 (Veh)	Q90 (Veh)	Q95 (Veh)	Percentile message	Marker message	Probability of reaching or exceeding marker	Probability of exactly reaching marker
B-AC	0.18	0.00	0.00	0.18	0.18			N/A	N/A
C-AB	0.08	0.00	0.00	0.08	0.08			N/A	N/A

2042 Faactored Base + 15yrs + Dev Flows x 2, AM

Data Errors and Warnings

Severity	Area	Item	Description
Warning	Demand Set Relationship	D4 - 2027 + Development Flows, AM	Demand Set relationships are chained. This may slow down the file.
Warning	Vehicle Mix		HV% is zero for all movements / time segments. Vehicle Mix matrix should be completed whether working in PCUs or Vehs. If HV% at the junction is genuinely zero, please ignore this warning.
Warning	Queue variations	Analysis Options	Queue percentiles may be unreliable if the mean queue in any time segment is very low or very high.

Junction Network

Junctions

Junction	Name	Junction type	Arm A Direction	Arm B Direction	Arm C Direction	Use circulating lanes	Junction Delay (s)	Junction LOS
1	Development Access	T-Junction	Two-way	Two-way	Two-way		3.46	A

Junction Network

Driving side	Lighting	Network residual capacity (%)	First arm reaching threshold	Network delay (s)	Network LOS
Left	Normal/unknown	12	Stream B-AC	3.46	A

Traffic Demand

Demand Set Details

ID	Scenario name	Time Period name	Traffic profile type	Start time (HH:mm)	Finish time (HH:mm)	Time segment length (min)	Run automatically	Relationship type	Relationship
D9	2042 Faactored Base + 15yrs + Dev Flows x 2	AM	ONE HOUR	09:00	10:30	15	✓	Simple	(D3*2)+D7

Demand overview (Traffic)

Arm	Linked arm	Profile type	Use O-D data	Average Demand (Veh/hr)	Scaling Factor (%)
A		ONE HOUR	✓	478	100.000
B		ONE HOUR	✓	26	100.000
C		ONE HOUR	✓	609	100.000

Origin-Destination Data

Demand (Veh/hr)

		To		
		A	B	C
From	A	0	14	464
	B	10	0	16
	C	585	24	0

Proportions

		To		
		A	B	C
From	A	0.00	0.03	0.97
	B	0.38	0.00	0.62
	C	0.96	0.04	0.00

Vehicle Mix

HV data entry mode	PCU Factor for a HV (PCU)
HV Percentages	2.00

Heavy Vehicle %

		To		
		A	B	C
From	A	0	0	0
	B	0	0	0
	C	0	0	0

Average PCU Per Veh

		To		
		A	B	C
From	A	1.000	1.000	1.000
	B	1.000	1.000	1.000
	C	1.000	1.000	1.000

Detailed Demand Data

Demand for each time segment

Arm	Time Segment	Demand (Veh/hr)	Demand in PCU (PCU/hr)
A	09:00-09:15	360	360
	09:15-09:30	430	430
	09:30-09:45	526	526

	09:45-10:00	526	526
	10:00-10:15	430	430
	10:15-10:30	360	360
B	09:00-09:15	20	20
	09:15-09:30	23	23
	09:30-09:45	29	29
	09:45-10:00	29	29
	10:00-10:15	23	23
	10:15-10:30	20	20
C	09:00-09:15	459	459
	09:15-09:30	548	548
	09:30-09:45	671	671
	09:45-10:00	671	671
	10:00-10:15	548	548
	10:15-10:30	459	459

Results

Results Summary for whole modelled period

Stream	Max RFC	Max Delay (s)	Max Queue (Veh)	Max 95th percentile Queue (Veh)	Max LOS	Average Demand (Veh/hr)	Total Junction Arrivals (Veh)
B-AC	0.55	23.09	1.2	5.2	C	158	237
C-AB	0.24	9.09	0.3	1.4	A	103	154
C-A						537	805
A-B						99	149
A-C						426	638

Main Results for each time segment

09:00 - 09:15

Stream	Total Demand (Veh/hr)	Junction Arrivals (Veh)	Capacity (Veh/hr)	RFC	Throughput (Veh/hr)	Start queue (Veh)	End queue (Veh)	Delay (s)	Unsignalised level of service
B-AC	129	32	420	0.308	128	0.0	0.4	12.252	B
C-AB	84	21	563	0.150	84	0.0	0.2	7.494	A
C-A	441	110			441				
A-B	81	20			81				
A-C	349	87			349				

09:15 - 09:30

Stream	Total Demand (Veh/hr)	Junction Arrivals (Veh)	Capacity (Veh/hr)	RFC	Throughput (Veh/hr)	Start queue (Veh)	End queue (Veh)	Delay (s)	Unsignalised level of service
B-AC	155	39	389	0.398	154	0.4	0.6	15.255	C
C-AB	101	25	545	0.185	101	0.2	0.2	8.103	A
C-A	526	132			526				
A-B	97	24			97				
A-C	417	104			417				

09:30 - 09:45

Stream	Total Demand (Veh/hr)	Junction Arrivals (Veh)	Capacity (Veh/hr)	RFC	Throughput (Veh/hr)	Start queue (Veh)	End queue (Veh)	Delay (s)	Unsignalised level of service
B-AC	189	47	345	0.549	187	0.6	1.2	22.544	C
C-AB	124	31	520	0.238	123	0.2	0.3	9.077	A
C-A	644	161			644				
A-B	119	30			119				
A-C	511	128			511				

09:45 - 10:00

Stream	Total Demand (Veh/hr)	Junction Arrivals (Veh)	Capacity (Veh/hr)	RFC	Throughput (Veh/hr)	Start queue (Veh)	End queue (Veh)	Delay (s)	Unsignalised level of service
B-AC	189	47	345	0.549	189	1.2	1.2	23.091	C
C-AB	124	31	520	0.238	124	0.3	0.3	9.092	A
C-A	644	161			644				
A-B	119	30			119				
A-C	511	128			511				

10:00 - 10:15

Stream	Total Demand (Veh/hr)	Junction Arrivals (Veh)	Capacity (Veh/hr)	RFC	Throughput (Veh/hr)	Start queue (Veh)	End queue (Veh)	Delay (s)	Unsignalised level of service
B-AC	155	39	389	0.398	157	1.2	0.7	15.639	C
C-AB	101	25	545	0.185	101	0.3	0.2	8.122	A
C-A	526	132			526				

A-B	97	24			97				
A-C	417	104			417				

10:15 - 10:30

Stream	Total Demand (Veh/hr)	Junction Arrivals (Veh)	Capacity (Veh/hr)	RFC	Throughput (Veh/hr)	Start queue (Veh)	End queue (Veh)	Delay (s)	Unsignalised level of service
B-AC	129	32	420	0.309	130	0.7	0.5	12.481	B
C-AB	84	21	563	0.150	85	0.2	0.2	7.524	A
C-A	441	110			441				
A-B	81	20			81				
A-C	349	87			349				

Queue Variation Results for each time segment**09:00 - 09:15**

Stream	Mean (Veh)	Q05 (Veh)	Q50 (Veh)	Q90 (Veh)	Q95 (Veh)	Percentile message	Marker message	Probability of reaching or exceeding marker	Probability of exactly reaching marker
B-AC	0.44	0.00	0.00	0.44	0.44			N/A	N/A
C-AB	0.17	0.00	0.00	0.17	0.17			N/A	N/A

09:15 - 09:30

Stream	Mean (Veh)	Q05 (Veh)	Q50 (Veh)	Q90 (Veh)	Q95 (Veh)	Percentile message	Marker message	Probability of reaching or exceeding marker	Probability of exactly reaching marker
B-AC	0.64	0.16	0.91	1.38	1.44			N/A	N/A
C-AB	0.22	0.00	0.00	0.22	0.22			N/A	N/A

09:30 - 09:45

Stream	Mean (Veh)	Q05 (Veh)	Q50 (Veh)	Q90 (Veh)	Q95 (Veh)	Percentile message	Marker message	Probability of reaching or exceeding marker	Probability of exactly reaching marker
B-AC	1.16	0.03	0.28	1.16	3.79			N/A	N/A
C-AB	0.31	0.03	0.26	0.46	0.49			N/A	N/A

09:45 - 10:00

Stream	Mean (Veh)	Q05 (Veh)	Q50 (Veh)	Q90 (Veh)	Q95 (Veh)	Percentile message	Marker message	Probability of reaching or exceeding marker	Probability of exactly reaching marker
B-AC	1.19	0.03	0.29	1.49	5.21			N/A	N/A
C-AB	0.31	0.03	0.31	1.10	1.41			N/A	N/A

10:00 - 10:15

Stream	Mean (Veh)	Q05 (Veh)	Q50 (Veh)	Q90 (Veh)	Q95 (Veh)	Percentile message	Marker message	Probability of reaching or exceeding marker	Probability of exactly reaching marker
B-AC	0.68	0.05	0.58	1.43	1.43			N/A	N/A
C-AB	0.23	0.00	0.00	0.23	0.23			N/A	N/A

10:15 - 10:30

Stream	Mean (Veh)	Q05 (Veh)	Q50 (Veh)	Q90 (Veh)	Q95 (Veh)	Percentile message	Marker message	Probability of reaching or exceeding marker	Probability of exactly reaching marker
B-AC	0.45	0.04	0.37	1.29	1.46			N/A	N/A
C-AB	0.18	0.00	0.00	0.18	0.18			N/A	N/A

2023, PM

Data Errors and Warnings

Severity	Area	Item	Description
Warning	Demand Set Relationship	D4 - 2027 + Development Flows, AM	Demand Set relationships are chained. This may slow down the file.
Warning	Vehicle Mix		HV% is zero for all movements / time segments. Vehicle Mix matrix should be completed whether working in PCUs or Vehs. If HV% at the junction is genuinely zero, please ignore this warning.
Warning	Queue variations	Analysis Options	Queue percentiles may be unreliable if the mean queue in any time segment is very low or very high.

Junction Network

Junctions

Junction	Name	Junction type	Arm A Direction	Arm B Direction	Arm C Direction	Use circulating lanes	Junction Delay (s)	Junction LOS
1	Development Access	T-Junction	Two-way	Two-way	Two-way		0.00	A

Junction Network

Driving side	Lighting	Network residual capacity (%)	First arm reaching threshold	Network delay (s)	Network LOS
Left	Normal/unknown	900		0.00	A

Traffic Demand

Demand Set Details

ID	Scenario name	Time Period name	Traffic profile type	Start time (HH:mm)	Finish time (HH:mm)	Time segment length (min)	Run automatically
D10	2023	PM	ONE HOUR	15:00	16:30	15	✓

Demand overview (Traffic)

Arm	Linked arm	Profile type	Use O-D data	Average Demand (Veh/hr)	Scaling Factor (%)
A		ONE HOUR	✓	501	100.000
B		ONE HOUR	✓	0	100.000
C		ONE HOUR	✓	820	100.000

Origin-Destination Data

Demand (Veh/hr)

		To		
		A	B	C
From	A	0	0	501
	B	0	0	0
	C	820	0	0

Proportions

		To		
		A	B	C
From	A	0.00	0.00	1.00
	B	0.33	0.33	0.33
	C	1.00	0.00	0.00

Vehicle Mix

HV data entry mode	PCU Factor for a HV (PCU)
HV Percentages	2.00

Heavy Vehicle %

		To		
		A	B	C
From	A	0	0	0
	B	0	0	0
	C	0	0	0

Average PCU Per Veh

		To		
		A	B	C
From	A	1.000	1.000	1.000
	B	1.000	1.000	1.000
	C	1.000	1.000	1.000

Detailed Demand Data

Demand for each time segment

Arm	Time Segment	Demand (Veh/hr)	Demand in PCU (PCU/hr)
A	15:00-15:15	377	377
	15:15-15:30	450	450
	15:30-15:45	552	552
	15:45-16:00	552	552
	16:00-16:15	450	450

	16:15-16:30	377	377
B	15:00-15:15	0	0
	15:15-15:30	0	0
	15:30-15:45	0	0
	15:45-16:00	0	0
	16:00-16:15	0	0
	16:15-16:30	0	0
C	15:00-15:15	617	617
	15:15-15:30	737	737
	15:30-15:45	903	903
	15:45-16:00	903	903
	16:00-16:15	737	737
	16:15-16:30	617	617

Results

Results Summary for whole modelled period

Stream	Max RFC	Max Delay (s)	Max Queue (Veh)	Max 95th percentile Queue (Veh)	Max LOS	Average Demand (Veh/hr)	Total Junction Arrivals (Veh)
B-AC	0.00	0.00	0.0	~1	A	0	0
C-AB	0.00	0.00	0.0	~1	A	0	0
C-A						752	1129
A-B						0	0
A-C						460	690

Main Results for each time segment

15:00 - 15:15

Stream	Total Demand (Veh/hr)	Junction Arrivals (Veh)	Capacity (Veh/hr)	RFC	Throughput (Veh/hr)	Start queue (Veh)	End queue (Veh)	Delay (s)	Unsignalised level of service
B-AC	0	0	440	0.000	0	0.0	0.0	0.000	A
C-AB	0	0	1151	0.000	0	0.0	0.0	0.000	A
C-A	617	154			617				
A-B	0	0			0				
A-C	377	94			377				

15:15 - 15:30

Stream	Total Demand (Veh/hr)	Junction Arrivals (Veh)	Capacity (Veh/hr)	RFC	Throughput (Veh/hr)	Start queue (Veh)	End queue (Veh)	Delay (s)	Unsignalised level of service
B-AC	0	0	411	0.000	0	0.0	0.0	0.000	A
C-AB	0	0	1117	0.000	0	0.0	0.0	0.000	A
C-A	737	184			737				
A-B	0	0			0				
A-C	450	113			450				

15:30 - 15:45

Stream	Total Demand (Veh/hr)	Junction Arrivals (Veh)	Capacity (Veh/hr)	RFC	Throughput (Veh/hr)	Start queue (Veh)	End queue (Veh)	Delay (s)	Unsignalised level of service
B-AC	0	0	369	0.000	0	0.0	0.0	0.000	A
C-AB	0	0	1071	0.000	0	0.0	0.0	0.000	A
C-A	903	226			903				
A-B	0	0			0				
A-C	552	138			552				

15:45 - 16:00

Stream	Total Demand (Veh/hr)	Junction Arrivals (Veh)	Capacity (Veh/hr)	RFC	Throughput (Veh/hr)	Start queue (Veh)	End queue (Veh)	Delay (s)	Unsignalised level of service
B-AC	0	0	369	0.000	0	0.0	0.0	0.000	A
C-AB	0	0	1071	0.000	0	0.0	0.0	0.000	A
C-A	903	226			903				
A-B	0	0			0				
A-C	552	138			552				

16:00 - 16:15

Stream	Total Demand (Veh/hr)	Junction Arrivals (Veh)	Capacity (Veh/hr)	RFC	Throughput (Veh/hr)	Start queue (Veh)	End queue (Veh)	Delay (s)	Unsignalised level of service
B-AC	0	0	411	0.000	0	0.0	0.0	0.000	A
C-AB	0	0	1117	0.000	0	0.0	0.0	0.000	A
C-A	737	184			737				
A-B	0	0			0				
A-C	450	113			450				

16:15 - 16:30

Stream	Total Demand (Veh/hr)	Junction Arrivals (Veh)	Capacity (Veh/hr)	RFC	Throughput (Veh/hr)	Start queue (Veh)	End queue (Veh)	Delay (s)	Unsignalised level of service
B-AC	0	0	440	0.000	0	0.0	0.0	0.000	A
C-AB	0	0	1151	0.000	0	0.0	0.0	0.000	A
C-A	617	154			617				
A-B	0	0			0				
A-C	377	94			377				

Queue Variation Results for each time segment

15:00 - 15:15

Stream	Mean (Veh)	Q05 (Veh)	Q50 (Veh)	Q90 (Veh)	Q95 (Veh)	Percentile message	Marker message	Probability of reaching or exceeding marker	Probability of exactly reaching marker
B-AC	0.00	0.00	0.00	0.00	0.00			N/A	N/A
C-AB	0.00	0.00	0.00	0.00	0.00			N/A	N/A

15:15 - 15:30

Stream	Mean (Veh)	Q05 (Veh)	Q50 (Veh)	Q90 (Veh)	Q95 (Veh)	Percentile message	Marker message	Probability of reaching or exceeding marker	Probability of exactly reaching marker
B-AC	0.00	0.00	0.00	0.00	0.00			N/A	N/A
C-AB	0.00	0.00	0.00	0.00	0.00			N/A	N/A

15:30 - 15:45

Stream	Mean (Veh)	Q05 (Veh)	Q50 (Veh)	Q90 (Veh)	Q95 (Veh)	Percentile message	Marker message	Probability of reaching or exceeding marker	Probability of exactly reaching marker
B-AC	0.00	0.00	0.00	0.00	0.00			N/A	N/A
C-AB	0.00	0.00	0.00	0.00	0.00			N/A	N/A

15:45 - 16:00

Stream	Mean (Veh)	Q05 (Veh)	Q50 (Veh)	Q90 (Veh)	Q95 (Veh)	Percentile message	Marker message	Probability of reaching or exceeding marker	Probability of exactly reaching marker
B-AC	0.00	0.00	0.00	0.00	0.00			N/A	N/A
C-AB	0.00	0.00	0.00	0.00	0.00			N/A	N/A

16:00 - 16:15

Stream	Mean (Veh)	Q05 (Veh)	Q50 (Veh)	Q90 (Veh)	Q95 (Veh)	Percentile message	Marker message	Probability of reaching or exceeding marker	Probability of exactly reaching marker
B-AC	0.00	0.00	0.00	0.00	0.00			N/A	N/A
C-AB	0.00	0.00	0.00	0.00	0.00			N/A	N/A

16:15 - 16:30

Stream	Mean (Veh)	Q05 (Veh)	Q50 (Veh)	Q90 (Veh)	Q95 (Veh)	Percentile message	Marker message	Probability of reaching or exceeding marker	Probability of exactly reaching marker
B-AC	0.00	0.00	0.00	0.00	0.00			N/A	N/A
C-AB	0.00	0.00	0.00	0.00	0.00			N/A	N/A

2027 - Opening Year, PM

Data Errors and Warnings

Severity	Area	Item	Description
Warning	Demand Set Relationship	D4 - 2027 + Development Flows, AM	Demand Set relationships are chained. This may slow down the file.
Warning	Vehicle Mix		HV% is zero for all movements / time segments. Vehicle Mix matrix should be completed whether working in PCUs or Vehs. If HV% at the junction is genuinely zero, please ignore this warning.
Warning	Queue variations	Analysis Options	Queue percentiles may be unreliable if the mean queue in any time segment is very low or very high.

Junction Network

Junctions

Junction	Name	Junction type	Arm A Direction	Arm B Direction	Arm C Direction	Use circulating lanes	Junction Delay (s)	Junction LOS
1	Development Access	T-Junction	Two-way	Two-way	Two-way		0.00	A

Junction Network

Driving side	Lighting	Network residual capacity (%)	First arm reaching threshold	Network delay (s)	Network LOS
Left	Normal/unknown	900		0.00	A

Traffic Demand

Demand Set Details

ID	Scenario name	Time Period name	Traffic profile type	Start time (HH:mm)	Finish time (HH:mm)	Time segment length (min)	Run automatically	Relationship type	Relationship
D11	2027 - Opening Year	PM	ONE HOUR	15:00	16:30	15	✓	Simple	D10*G1

Demand overview (Traffic)

Arm	Linked arm	Profile type	Use O-D data	Average Demand (Veh/hr)	Scaling Factor (%)
A		ONE HOUR	✓	526	100.000
B		ONE HOUR	✓	0	100.000
C		ONE HOUR	✓	860	100.000

Origin-Destination Data

Demand (Veh/hr)

	To			
	A	B	C	
From	A	0	0	526
	B	0	0	0
	C	860	0	0

Proportions

	To			
	A	B	C	
From	A	0.00	0.00	1.00
	B	0.33	0.33	0.33
	C	1.00	0.00	0.00

Vehicle Mix

HV data entry mode	PCU Factor for a HV (PCU)
HV Percentages	2.00

Heavy Vehicle %

	To			
	A	B	C	
From	A	0	0	0
	B	0	0	0
	C	0	0	0

Average PCU Per Veh

	To			
	A	B	C	
From	A	1.000	1.000	1.000
	B	1.000	1.000	1.000
	C	1.000	1.000	1.000

Detailed Demand Data

Demand for each time segment

Arm	Time Segment	Demand (Veh/hr)	Demand in PCU (PCU/hr)
A	15:00-15:15	396	396
	15:15-15:30	472	472
	15:30-15:45	579	579
	15:45-16:00	579	579
	16:00-16:15	472	472

	16:15-16:30	396	396
B	15:00-15:15	0	0
	15:15-15:30	0	0
	15:30-15:45	0	0
	15:45-16:00	0	0
	16:00-16:15	0	0
	16:15-16:30	0	0
C	15:00-15:15	648	648
	15:15-15:30	773	773
	15:30-15:45	947	947
	15:45-16:00	947	947
	16:00-16:15	773	773
	16:15-16:30	648	648

Results

Results Summary for whole modelled period

Stream	Max RFC	Max Delay (s)	Max Queue (Veh)	Max 95th percentile Queue (Veh)	Max LOS	Average Demand (Veh/hr)	Total Junction Arrivals (Veh)
B-AC	0.00	0.00	0.0	~1	A	0	0
C-AB	0.00	0.00	0.0	~1	A	0	0
C-A						789	1184
A-B						0	0
A-C						482	723

Main Results for each time segment

15:00 - 15:15

Stream	Total Demand (Veh/hr)	Junction Arrivals (Veh)	Capacity (Veh/hr)	RFC	Throughput (Veh/hr)	Start queue (Veh)	End queue (Veh)	Delay (s)	Unsignalised level of service
B-AC	0	0	433	0.000	0	0.0	0.0	0.000	A
C-AB	0	0	1142	0.000	0	0.0	0.0	0.000	A
C-A	648	162			648				
A-B	0	0			0				
A-C	396	99			396				

15:15 - 15:30

Stream	Total Demand (Veh/hr)	Junction Arrivals (Veh)	Capacity (Veh/hr)	RFC	Throughput (Veh/hr)	Start queue (Veh)	End queue (Veh)	Delay (s)	Unsignalised level of service
B-AC	0	0	402	0.000	0	0.0	0.0	0.000	A
C-AB	0	0	1107	0.000	0	0.0	0.0	0.000	A
C-A	773	193			773				
A-B	0	0			0				
A-C	472	118			472				

15:30 - 15:45

Stream	Total Demand (Veh/hr)	Junction Arrivals (Veh)	Capacity (Veh/hr)	RFC	Throughput (Veh/hr)	Start queue (Veh)	End queue (Veh)	Delay (s)	Unsignalised level of service
B-AC	0	0	357	0.000	0	0.0	0.0	0.000	A
C-AB	0	0	1059	0.000	0	0.0	0.0	0.000	A
C-A	947	237			947				
A-B	0	0			0				
A-C	579	145			579				

15:45 - 16:00

Stream	Total Demand (Veh/hr)	Junction Arrivals (Veh)	Capacity (Veh/hr)	RFC	Throughput (Veh/hr)	Start queue (Veh)	End queue (Veh)	Delay (s)	Unsignalised level of service
B-AC	0	0	357	0.000	0	0.0	0.0	0.000	A
C-AB	0	0	1059	0.000	0	0.0	0.0	0.000	A
C-A	947	237			947				
A-B	0	0			0				
A-C	579	145			579				

16:00 - 16:15

Stream	Total Demand (Veh/hr)	Junction Arrivals (Veh)	Capacity (Veh/hr)	RFC	Throughput (Veh/hr)	Start queue (Veh)	End queue (Veh)	Delay (s)	Unsignalised level of service
B-AC	0	0	402	0.000	0	0.0	0.0	0.000	A
C-AB	0	0	1107	0.000	0	0.0	0.0	0.000	A
C-A	773	193			773				
A-B	0	0			0				
A-C	472	118			472				

16:15 - 16:30

Stream	Total Demand (Veh/hr)	Junction Arrivals (Veh)	Capacity (Veh/hr)	RFC	Throughput (Veh/hr)	Start queue (Veh)	End queue (Veh)	Delay (s)	Unsignalised level of service
B-AC	0	0	433	0.000	0	0.0	0.0	0.000	A
C-AB	0	0	1142	0.000	0	0.0	0.0	0.000	A
C-A	648	162			648				
A-B	0	0			0				
A-C	396	99			396				

Queue Variation Results for each time segment

15:00 - 15:15

Stream	Mean (Veh)	Q05 (Veh)	Q50 (Veh)	Q90 (Veh)	Q95 (Veh)	Percentile message	Marker message	Probability of reaching or exceeding marker	Probability of exactly reaching marker
B-AC	0.00	0.00	0.00	0.00	0.00			N/A	N/A
C-AB	0.00	0.00	0.00	0.00	0.00			N/A	N/A

15:15 - 15:30

Stream	Mean (Veh)	Q05 (Veh)	Q50 (Veh)	Q90 (Veh)	Q95 (Veh)	Percentile message	Marker message	Probability of reaching or exceeding marker	Probability of exactly reaching marker
B-AC	0.00	0.00	0.00	0.00	0.00			N/A	N/A
C-AB	0.00	0.00	0.00	0.00	0.00			N/A	N/A

15:30 - 15:45

Stream	Mean (Veh)	Q05 (Veh)	Q50 (Veh)	Q90 (Veh)	Q95 (Veh)	Percentile message	Marker message	Probability of reaching or exceeding marker	Probability of exactly reaching marker
B-AC	0.00	0.00	0.00	0.00	0.00			N/A	N/A
C-AB	0.00	0.00	0.00	0.00	0.00			N/A	N/A

15:45 - 16:00

Stream	Mean (Veh)	Q05 (Veh)	Q50 (Veh)	Q90 (Veh)	Q95 (Veh)	Percentile message	Marker message	Probability of reaching or exceeding marker	Probability of exactly reaching marker
B-AC	0.00	0.00	0.00	0.00	0.00			N/A	N/A
C-AB	0.00	0.00	0.00	0.00	0.00			N/A	N/A

16:00 - 16:15

Stream	Mean (Veh)	Q05 (Veh)	Q50 (Veh)	Q90 (Veh)	Q95 (Veh)	Percentile message	Marker message	Probability of reaching or exceeding marker	Probability of exactly reaching marker
B-AC	0.00	0.00	0.00	0.00	0.00			N/A	N/A
C-AB	0.00	0.00	0.00	0.00	0.00			N/A	N/A

16:15 - 16:30

Stream	Mean (Veh)	Q05 (Veh)	Q50 (Veh)	Q90 (Veh)	Q95 (Veh)	Percentile message	Marker message	Probability of reaching or exceeding marker	Probability of exactly reaching marker
B-AC	0.00	0.00	0.00	0.00	0.00			N/A	N/A
C-AB	0.00	0.00	0.00	0.00	0.00			N/A	N/A

Development Flows, PM

Data Errors and Warnings

Severity	Area	Item	Description
Warning	Demand Set Relationship	D4 - 2027 + Development Flows, AM	Demand Set relationships are chained. This may slow down the file.
Warning	Vehicle Mix		HV% is zero for all movements / time segments. Vehicle Mix matrix should be completed whether working in PCUs or Vehs. If HV% at the junction is genuinely zero, please ignore this warning.
Warning	Queue variations	Analysis Options	Queue percentiles may be unreliable if the mean queue in any time segment is very low or very high.

Junction Network

Junctions

Junction	Name	Junction type	Arm A Direction	Arm B Direction	Arm C Direction	Use circulating lanes	Junction Delay (s)	Junction LOS
1	Development Access	T-Junction	Two-way	Two-way	Two-way		4.96	A

Junction Network

Driving side	Lighting	Network residual capacity (%)	First arm reaching threshold	Network delay (s)	Network LOS
Left	Normal/unknown	678	Stream C-AB	4.96	A

Traffic Demand

Demand Set Details

ID	Scenario name	Time Period name	Traffic profile type	Start time (HH:mm)	Finish time (HH:mm)	Time segment length (min)	Run automatically
D12	Development Flows	PM	ONE HOUR	15:00	16:30	15	✓

Demand overview (Traffic)

Arm	Linked arm	Profile type	Use O-D data	Average Demand (Veh/hr)	Scaling Factor (%)
A		ONE HOUR	✓	18	100.000
B		ONE HOUR	✓	13	100.000
C		ONE HOUR	✓	62	100.000

Origin-Destination Data

Demand (Veh/hr)

		To		
		A	B	C
From	A	0	18	0
	B	5	0	8
	C	0	62	0

Proportions

		To		
		A	B	C
From	A	0.00	1.00	0.00
	B	0.38	0.00	0.62
	C	0.00	1.00	0.00

Vehicle Mix

HV data entry mode	PCU Factor for a HV (PCU)
HV Percentages	2.00

Heavy Vehicle %

		To		
		A	B	C
From	A	0	0	0
	B	0	0	0
	C	0	0	0

Average PCU Per Veh

		To		
		A	B	C
From	A	1.000	1.000	1.000
	B	1.000	1.000	1.000
	C	1.000	1.000	1.000

Detailed Demand Data

Demand for each time segment

Arm	Time Segment	Demand (Veh/hr)	Demand in PCU (PCU/hr)
A	15:00-15:15	14	14
	15:15-15:30	16	16
	15:30-15:45	20	20
	15:45-16:00	20	20
	16:00-16:15	16	16

	16:15-16:30	14	14
B	15:00-15:15	10	10
	15:15-15:30	12	12
	15:30-15:45	14	14
	15:45-16:00	14	14
	16:00-16:15	12	12
	16:15-16:30	10	10
C	15:00-15:15	47	47
	15:15-15:30	56	56
	15:30-15:45	68	68
	15:45-16:00	68	68
	16:00-16:15	56	56
	16:15-16:30	47	47

Results

Results Summary for whole modelled period

Stream	Max RFC	Max Delay (s)	Max Queue (Veh)	Max 95th percentile Queue (Veh)	Max LOS	Average Demand (Veh/hr)	Total Junction Arrivals (Veh)
B-AC	0.02	6.32	0.0	0.5	A	12	18
C-AB	0.10	6.11	0.1	0.5	A	57	85
C-A						0	0
A-B						17	25
A-C						0	0

Main Results for each time segment

15:00 - 15:15

Stream	Total Demand (Veh/hr)	Junction Arrivals (Veh)	Capacity (Veh/hr)	RFC	Throughput (Veh/hr)	Start queue (Veh)	End queue (Veh)	Delay (s)	Unsignalised level of service
B-AC	10	2	588	0.017	10	0.0	0.0	6.229	A
C-AB	47	12	658	0.071	46	0.0	0.1	5.879	A
C-A	0	0			0				
A-B	14	3			14				
A-C	0	0			0				

15:15 - 15:30

Stream	Total Demand (Veh/hr)	Junction Arrivals (Veh)	Capacity (Veh/hr)	RFC	Throughput (Veh/hr)	Start queue (Veh)	End queue (Veh)	Delay (s)	Unsignalised level of service
B-AC	12	3	586	0.020	12	0.0	0.0	6.269	A
C-AB	56	14	658	0.085	56	0.1	0.1	5.978	A
C-A	0	0			0				
A-B	16	4			16				
A-C	0	0			0				

15:30 - 15:45

Stream	Total Demand (Veh/hr)	Junction Arrivals (Veh)	Capacity (Veh/hr)	RFC	Throughput (Veh/hr)	Start queue (Veh)	End queue (Veh)	Delay (s)	Unsignalised level of service
B-AC	14	4	584	0.025	14	0.0	0.0	6.323	A
C-AB	68	17	657	0.104	68	0.1	0.1	6.114	A
C-A	0	0			0				
A-B	20	5			20				
A-C	0	0			0				

15:45 - 16:00

Stream	Total Demand (Veh/hr)	Junction Arrivals (Veh)	Capacity (Veh/hr)	RFC	Throughput (Veh/hr)	Start queue (Veh)	End queue (Veh)	Delay (s)	Unsignalised level of service
B-AC	14	4	584	0.025	14	0.0	0.0	6.323	A
C-AB	68	17	657	0.104	68	0.1	0.1	6.114	A
C-A	0	0			0				
A-B	20	5			20				
A-C	0	0			0				

16:00 - 16:15

Stream	Total Demand (Veh/hr)	Junction Arrivals (Veh)	Capacity (Veh/hr)	RFC	Throughput (Veh/hr)	Start queue (Veh)	End queue (Veh)	Delay (s)	Unsignalised level of service
B-AC	12	3	586	0.020	12	0.0	0.0	6.272	A
C-AB	56	14	658	0.085	56	0.1	0.1	5.980	A
C-A	0	0			0				
A-B	16	4			16				
A-C	0	0			0				

16:15 - 16:30

Stream	Total Demand (Veh/hr)	Junction Arrivals (Veh)	Capacity (Veh/hr)	RFC	Throughput (Veh/hr)	Start queue (Veh)	End queue (Veh)	Delay (s)	Unsignalised level of service
B-AC	10	2	588	0.017	10	0.0	0.0	6.233	A
C-AB	47	12	658	0.071	47	0.1	0.1	5.888	A
C-A	0	0			0				
A-B	14	3			14				
A-C	0	0			0				

Queue Variation Results for each time segment

15:00 - 15:15

Stream	Mean (Veh)	Q05 (Veh)	Q50 (Veh)	Q90 (Veh)	Q95 (Veh)	Percentile message	Marker message	Probability of reaching or exceeding marker	Probability of exactly reaching marker
B-AC	0.02	0.00	0.00	0.02	0.02			N/A	N/A
C-AB	0.08	0.00	0.00	0.08	0.08			N/A	N/A

15:15 - 15:30

Stream	Mean (Veh)	Q05 (Veh)	Q50 (Veh)	Q90 (Veh)	Q95 (Veh)	Percentile message	Marker message	Probability of reaching or exceeding marker	Probability of exactly reaching marker
B-AC	0.02	0.02	0.25	0.45	0.48			N/A	N/A
C-AB	0.09	0.03	0.25	0.46	0.48			N/A	N/A

15:30 - 15:45

Stream	Mean (Veh)	Q05 (Veh)	Q50 (Veh)	Q90 (Veh)	Q95 (Veh)	Percentile message	Marker message	Probability of reaching or exceeding marker	Probability of exactly reaching marker
B-AC	0.02	0.00	0.00	0.02	0.02			N/A	N/A
C-AB	0.12	0.03	0.26	0.46	0.49			N/A	N/A

15:45 - 16:00

Stream	Mean (Veh)	Q05 (Veh)	Q50 (Veh)	Q90 (Veh)	Q95 (Veh)	Percentile message	Marker message	Probability of reaching or exceeding marker	Probability of exactly reaching marker
B-AC	0.03	0.00	0.00	0.03	0.03			N/A	N/A
C-AB	0.12	0.03	0.25	0.45	0.48			N/A	N/A

16:00 - 16:15

Stream	Mean (Veh)	Q05 (Veh)	Q50 (Veh)	Q90 (Veh)	Q95 (Veh)	Percentile message	Marker message	Probability of reaching or exceeding marker	Probability of exactly reaching marker
B-AC	0.02	0.00	0.00	0.02	0.02			N/A	N/A
C-AB	0.09	0.00	0.00	0.09	0.09			N/A	N/A

16:15 - 16:30

Stream	Mean (Veh)	Q05 (Veh)	Q50 (Veh)	Q90 (Veh)	Q95 (Veh)	Percentile message	Marker message	Probability of reaching or exceeding marker	Probability of exactly reaching marker
B-AC	0.02	0.00	0.00	0.02	0.02			N/A	N/A
C-AB	0.08	0.00	0.00	0.08	0.08			N/A	N/A

2027 + Development Flows, PM

Data Errors and Warnings

Severity	Area	Item	Description
Warning	Demand Set Relationship	D4 - 2027 + Development Flows, AM	Demand Set relationships are chained. This may slow down the file.
Warning	Vehicle Mix		HV% is zero for all movements / time segments. Vehicle Mix matrix should be completed whether working in PCUs or Vehs. If HV% at the junction is genuinely zero, please ignore this warning.
Warning	Queue variations	Analysis Options	Queue percentiles may be unreliable if the mean queue in any time segment is very low or very high.

Junction Network

Junctions

Junction	Name	Junction type	Arm A Direction	Arm B Direction	Arm C Direction	Use circulating lanes	Junction Delay (s)	Junction LOS
1	Development Access	T-Junction	Two-way	Two-way	Two-way		0.87	A

Junction Network

Driving side	Lighting	Network residual capacity (%)	First arm reaching threshold	Network delay (s)	Network LOS
Left	Normal/unknown	41	Stream B-AC	0.87	A

Traffic Demand

Demand Set Details

ID	Scenario name	Time Period name	Traffic profile type	Start time (HH:mm)	Finish time (HH:mm)	Time segment length (min)	Run automatically	Relationship type	Relationship
D13	2027 + Development Flows	PM	ONE HOUR	15:00	16:30	15	✓	Simple	D11+D12

Demand overview (Traffic)

Arm	Linked arm	Profile type	Use O-D data	Average Demand (Veh/hr)	Scaling Factor (%)
A		ONE HOUR	✓	544	100.000
B		ONE HOUR	✓	13	100.000
C		ONE HOUR	✓	922	100.000

Origin-Destination Data

Demand (Veh/hr)

		To		
		A	B	C
From	A	0	18	526
	B	5	0	8
	C	860	62	0

Proportions

		To		
		A	B	C
From	A	0.00	0.03	0.97
	B	0.38	0.00	0.62
	C	0.93	0.07	0.00

Vehicle Mix

HV data entry mode	PCU Factor for a HV (PCU)
HV Percentages	2.00

Heavy Vehicle %

		To		
		A	B	C
From	A	0	0	0
	B	0	0	0
	C	0	0	0

Average PCU Per Veh

		To		
		A	B	C
From	A	1.000	1.000	1.000
	B	1.000	1.000	1.000
	C	1.000	1.000	1.000

Detailed Demand Data

Demand for each time segment

Arm	Time Segment	Demand (Veh/hr)	Demand in PCU (PCU/hr)
A	15:00-15:15	409	409
	15:15-15:30	489	489
	15:30-15:45	598	598
	15:45-16:00	598	598
	16:00-16:15	489	489

	16:15-16:30	409	409
B	15:00-15:15	10	10
	15:15-15:30	12	12
	15:30-15:45	14	14
	15:45-16:00	14	14
	16:00-16:15	12	12
	16:15-16:30	10	10
C	15:00-15:15	694	694
	15:15-15:30	829	829
	15:30-15:45	1015	1015
	15:45-16:00	1015	1015
	16:00-16:15	829	829
	16:15-16:30	694	694

Results

Results Summary for whole modelled period

Stream	Max RFC	Max Delay (s)	Max Queue (Veh)	Max 95th percentile Queue (Veh)	Max LOS	Average Demand (Veh/hr)	Total Junction Arrivals (Veh)
B-AC	0.21	13.81	0.3	1.2	B	58	87
C-AB	0.13	8.08	0.2	0.5	A	57	85
C-A						789	1184
A-B						57	85
A-C						482	723

Main Results for each time segment

15:00 - 15:15

Stream	Total Demand (Veh/hr)	Junction Arrivals (Veh)	Capacity (Veh/hr)	RFC	Throughput (Veh/hr)	Start queue (Veh)	End queue (Veh)	Delay (s)	Unsignalised level of service
B-AC	47	12	416	0.114	47	0.0	0.1	9.749	A
C-AB	47	12	560	0.083	46	0.0	0.1	6.997	A
C-A	648	162			648				
A-B	47	12			47				
A-C	396	99			396				

15:15 - 15:30

Stream	Total Demand (Veh/hr)	Junction Arrivals (Veh)	Capacity (Veh/hr)	RFC	Throughput (Veh/hr)	Start queue (Veh)	End queue (Veh)	Delay (s)	Unsignalised level of service
B-AC	57	14	381	0.149	56	0.1	0.2	11.094	B
C-AB	56	14	541	0.103	56	0.1	0.1	7.416	A
C-A	773	193			773				
A-B	56	14			56				
A-C	472	118			472				

15:30 - 15:45

Stream	Total Demand (Veh/hr)	Junction Arrivals (Veh)	Capacity (Veh/hr)	RFC	Throughput (Veh/hr)	Start queue (Veh)	End queue (Veh)	Delay (s)	Unsignalised level of service
B-AC	69	17	330	0.210	69	0.2	0.3	13.771	B
C-AB	68	17	514	0.133	68	0.1	0.2	8.072	A
C-A	947	237			947				
A-B	68	17			68				
A-C	579	145			579				

15:45 - 16:00

Stream	Total Demand (Veh/hr)	Junction Arrivals (Veh)	Capacity (Veh/hr)	RFC	Throughput (Veh/hr)	Start queue (Veh)	End queue (Veh)	Delay (s)	Unsignalised level of service
B-AC	69	17	330	0.210	69	0.3	0.3	13.811	B
C-AB	68	17	514	0.133	68	0.2	0.2	8.076	A
C-A	947	237			947				
A-B	68	17			68				
A-C	579	145			579				

16:00 - 16:15

Stream	Total Demand (Veh/hr)	Junction Arrivals (Veh)	Capacity (Veh/hr)	RFC	Throughput (Veh/hr)	Start queue (Veh)	End queue (Veh)	Delay (s)	Unsignalised level of service
B-AC	57	14	381	0.149	57	0.3	0.2	11.131	B
C-AB	56	14	541	0.103	56	0.2	0.1	7.426	A
C-A	773	193			773				
A-B	56	14			56				
A-C	472	118			472				

16:15 - 16:30

Stream	Total Demand (Veh/hr)	Junction Arrivals (Veh)	Capacity (Veh/hr)	RFC	Throughput (Veh/hr)	Start queue (Veh)	End queue (Veh)	Delay (s)	Unsignalised level of service
B-AC	47	12	416	0.114	48	0.2	0.1	9.787	A
C-AB	47	12	560	0.083	47	0.1	0.1	7.008	A
C-A	648	162			648				
A-B	47	12			47				
A-C	396	99			396				

Queue Variation Results for each time segment

15:00 - 15:15

Stream	Mean (Veh)	Q05 (Veh)	Q50 (Veh)	Q90 (Veh)	Q95 (Veh)	Percentile message	Marker message	Probability of reaching or exceeding marker	Probability of exactly reaching marker
B-AC	0.13	0.00	0.00	0.13	0.13			N/A	N/A
C-AB	0.09	0.00	0.00	0.09	0.09			N/A	N/A

15:15 - 15:30

Stream	Mean (Veh)	Q05 (Veh)	Q50 (Veh)	Q90 (Veh)	Q95 (Veh)	Percentile message	Marker message	Probability of reaching or exceeding marker	Probability of exactly reaching marker
B-AC	0.17	0.00	0.00	0.17	0.17			N/A	N/A
C-AB	0.11	0.00	0.00	0.11	0.11			N/A	N/A

15:30 - 15:45

Stream	Mean (Veh)	Q05 (Veh)	Q50 (Veh)	Q90 (Veh)	Q95 (Veh)	Percentile message	Marker message	Probability of reaching or exceeding marker	Probability of exactly reaching marker
B-AC	0.26	0.03	0.26	0.47	0.49			N/A	N/A
C-AB	0.15	0.03	0.26	0.46	0.49			N/A	N/A

15:45 - 16:00

Stream	Mean (Veh)	Q05 (Veh)	Q50 (Veh)	Q90 (Veh)	Q95 (Veh)	Percentile message	Marker message	Probability of reaching or exceeding marker	Probability of exactly reaching marker
B-AC	0.26	0.03	0.30	0.91	1.24			N/A	N/A
C-AB	0.15	0.03	0.25	0.45	0.48			N/A	N/A

16:00 - 16:15

Stream	Mean (Veh)	Q05 (Veh)	Q50 (Veh)	Q90 (Veh)	Q95 (Veh)	Percentile message	Marker message	Probability of reaching or exceeding marker	Probability of exactly reaching marker
B-AC	0.18	0.00	0.00	0.18	0.18			N/A	N/A
C-AB	0.12	0.00	0.00	0.12	0.12			N/A	N/A

16:15 - 16:30

Stream	Mean (Veh)	Q05 (Veh)	Q50 (Veh)	Q90 (Veh)	Q95 (Veh)	Percentile message	Marker message	Probability of reaching or exceeding marker	Probability of exactly reaching marker
B-AC	0.13	0.00	0.00	0.13	0.13			N/A	N/A
C-AB	0.09	0.00	0.00	0.09	0.09			N/A	N/A

2032 Faactored Base + 5yrs, PM

Data Errors and Warnings

Severity	Area	Item	Description
Warning	Demand Set Relationship	D4 - 2027 + Development Flows, AM	Demand Set relationships are chained. This may slow down the file.
Warning	Vehicle Mix		HV% is zero for all movements / time segments. Vehicle Mix matrix should be completed whether working in PCUs or Vehs. If HV% at the junction is genuinely zero, please ignore this warning.
Warning	Queue variations	Analysis Options	Queue percentiles may be unreliable if the mean queue in any time segment is very low or very high.

Junction Network

Junctions

Junction	Name	Junction type	Arm A Direction	Arm B Direction	Arm C Direction	Use circulating lanes	Junction Delay (s)	Junction LOS
1	Development Access	T-Junction	Two-way	Two-way	Two-way		0.00	A

Junction Network

Driving side	Lighting	Network residual capacity (%)	First arm reaching threshold	Network delay (s)	Network LOS
Left	Normal/unknown	900		0.00	A

Traffic Demand

Demand Set Details

ID	Scenario name	Time Period name	Traffic profile type	Start time (HH:mm)	Finish time (HH:mm)	Time segment length (min)	Run automatically	Relationship type	Relationship
D14	2032 Faactored Base + 5yrs	PM	ONE HOUR	15:00	16:30	15	✓	Simple	D10*G2

Demand overview (Traffic)

Arm	Linked arm	Profile type	Use O-D data	Average Demand (Veh/hr)	Scaling Factor (%)
A		ONE HOUR	✓	543	100.000
B		ONE HOUR	✓	0	100.000
C		ONE HOUR	✓	888	100.000

Origin-Destination Data

Demand (Veh/hr)

	To			
	A	B	C	
From	A	0	0	543
	B	0	0	0
	C	888	0	0

Proportions

	To			
	A	B	C	
From	A	0.00	0.00	1.00
	B	0.33	0.33	0.33
	C	1.00	0.00	0.00

Vehicle Mix

HV data entry mode	PCU Factor for a HV (PCU)
HV Percentages	2.00

Heavy Vehicle %

	To			
	A	B	C	
From	A	0	0	0
	B	0	0	0
	C	0	0	0

Average PCU Per Veh

	To			
	A	B	C	
From	A	1.000	1.000	1.000
	B	1.000	1.000	1.000
	C	1.000	1.000	1.000

Detailed Demand Data

Demand for each time segment

Arm	Time Segment	Demand (Veh/hr)	Demand in PCU (PCU/hr)
A	15:00-15:15	408	408
	15:15-15:30	488	488
	15:30-15:45	597	597
	15:45-16:00	597	597
	16:00-16:15	488	488

	16:15-16:30	408	408
B	15:00-15:15	0	0
	15:15-15:30	0	0
	15:30-15:45	0	0
	15:45-16:00	0	0
	16:00-16:15	0	0
	16:15-16:30	0	0
C	15:00-15:15	669	669
	15:15-15:30	798	798
	15:30-15:45	978	978
	15:45-16:00	978	978
	16:00-16:15	798	798
	16:15-16:30	669	669

Results

Results Summary for whole modelled period

Stream	Max RFC	Max Delay (s)	Max Queue (Veh)	Max 95th percentile Queue (Veh)	Max LOS	Average Demand (Veh/hr)	Total Junction Arrivals (Veh)
B-AC	0.00	0.00	0.0	~1	A	0	0
C-AB	0.00	0.00	0.0	~1	A	0	0
C-A						815	1222
A-B						0	0
A-C						498	747

Main Results for each time segment

15:00 - 15:15

Stream	Total Demand (Veh/hr)	Junction Arrivals (Veh)	Capacity (Veh/hr)	RFC	Throughput (Veh/hr)	Start queue (Veh)	End queue (Veh)	Delay (s)	Unsignalised level of service
B-AC	0	0	428	0.000	0	0.0	0.0	0.000	A
C-AB	0	0	1136	0.000	0	0.0	0.0	0.000	A
C-A	669	167			669				
A-B	0	0			0				
A-C	408	102			408				

15:15 - 15:30

Stream	Total Demand (Veh/hr)	Junction Arrivals (Veh)	Capacity (Veh/hr)	RFC	Throughput (Veh/hr)	Start queue (Veh)	End queue (Veh)	Delay (s)	Unsignalised level of service
B-AC	0	0	396	0.000	0	0.0	0.0	0.000	A
C-AB	0	0	1100	0.000	0	0.0	0.0	0.000	A
C-A	798	200			798				
A-B	0	0			0				
A-C	488	122			488				

15:30 - 15:45

Stream	Total Demand (Veh/hr)	Junction Arrivals (Veh)	Capacity (Veh/hr)	RFC	Throughput (Veh/hr)	Start queue (Veh)	End queue (Veh)	Delay (s)	Unsignalised level of service
B-AC	0	0	349	0.000	0	0.0	0.0	0.000	A
C-AB	0	0	1050	0.000	0	0.0	0.0	0.000	A
C-A	978	244			978				
A-B	0	0			0				
A-C	597	149			597				

15:45 - 16:00

Stream	Total Demand (Veh/hr)	Junction Arrivals (Veh)	Capacity (Veh/hr)	RFC	Throughput (Veh/hr)	Start queue (Veh)	End queue (Veh)	Delay (s)	Unsignalised level of service
B-AC	0	0	349	0.000	0	0.0	0.0	0.000	A
C-AB	0	0	1050	0.000	0	0.0	0.0	0.000	A
C-A	978	244			978				
A-B	0	0			0				
A-C	597	149			597				

16:00 - 16:15

Stream	Total Demand (Veh/hr)	Junction Arrivals (Veh)	Capacity (Veh/hr)	RFC	Throughput (Veh/hr)	Start queue (Veh)	End queue (Veh)	Delay (s)	Unsignalised level of service
B-AC	0	0	396	0.000	0	0.0	0.0	0.000	A
C-AB	0	0	1100	0.000	0	0.0	0.0	0.000	A
C-A	798	200			798				
A-B	0	0			0				
A-C	488	122			488				

16:15 - 16:30

Stream	Total Demand (Veh/hr)	Junction Arrivals (Veh)	Capacity (Veh/hr)	RFC	Throughput (Veh/hr)	Start queue (Veh)	End queue (Veh)	Delay (s)	Unsignalised level of service
B-AC	0	0	428	0.000	0	0.0	0.0	0.000	A
C-AB	0	0	1136	0.000	0	0.0	0.0	0.000	A
C-A	669	167			669				
A-B	0	0			0				
A-C	408	102			408				

Queue Variation Results for each time segment

15:00 - 15:15

Stream	Mean (Veh)	Q05 (Veh)	Q50 (Veh)	Q90 (Veh)	Q95 (Veh)	Percentile message	Marker message	Probability of reaching or exceeding marker	Probability of exactly reaching marker
B-AC	0.00	0.00	0.00	0.00	0.00			N/A	N/A
C-AB	0.00	0.00	0.00	0.00	0.00			N/A	N/A

15:15 - 15:30

Stream	Mean (Veh)	Q05 (Veh)	Q50 (Veh)	Q90 (Veh)	Q95 (Veh)	Percentile message	Marker message	Probability of reaching or exceeding marker	Probability of exactly reaching marker
B-AC	0.00	0.00	0.00	0.00	0.00			N/A	N/A
C-AB	0.00	0.00	0.00	0.00	0.00			N/A	N/A

15:30 - 15:45

Stream	Mean (Veh)	Q05 (Veh)	Q50 (Veh)	Q90 (Veh)	Q95 (Veh)	Percentile message	Marker message	Probability of reaching or exceeding marker	Probability of exactly reaching marker
B-AC	0.00	0.00	0.00	0.00	0.00			N/A	N/A
C-AB	0.00	0.00	0.00	0.00	0.00			N/A	N/A

15:45 - 16:00

Stream	Mean (Veh)	Q05 (Veh)	Q50 (Veh)	Q90 (Veh)	Q95 (Veh)	Percentile message	Marker message	Probability of reaching or exceeding marker	Probability of exactly reaching marker
B-AC	0.00	0.00	0.00	0.00	0.00			N/A	N/A
C-AB	0.00	0.00	0.00	0.00	0.00			N/A	N/A

16:00 - 16:15

Stream	Mean (Veh)	Q05 (Veh)	Q50 (Veh)	Q90 (Veh)	Q95 (Veh)	Percentile message	Marker message	Probability of reaching or exceeding marker	Probability of exactly reaching marker
B-AC	0.00	0.00	0.00	0.00	0.00			N/A	N/A
C-AB	0.00	0.00	0.00	0.00	0.00			N/A	N/A

16:15 - 16:30

Stream	Mean (Veh)	Q05 (Veh)	Q50 (Veh)	Q90 (Veh)	Q95 (Veh)	Percentile message	Marker message	Probability of reaching or exceeding marker	Probability of exactly reaching marker
B-AC	0.00	0.00	0.00	0.00	0.00			N/A	N/A
C-AB	0.00	0.00	0.00	0.00	0.00			N/A	N/A

2032 Faactored Base + Dev Flows = +5yrs, PM

Data Errors and Warnings

Severity	Area	Item	Description
Warning	Demand Set Relationship	D4 - 2027 + Development Flows, AM	Demand Set relationships are chained. This may slow down the file.
Warning	Vehicle Mix		HV% is zero for all movements / time segments. Vehicle Mix matrix should be completed whether working in PCUs or Vehs. If HV% at the junction is genuinely zero, please ignore this warning.
Warning	Queue variations	Analysis Options	Queue percentiles may be unreliable if the mean queue in any time segment is very low or very high.

Junction Network

Junctions

Junction	Name	Junction type	Arm A Direction	Arm B Direction	Arm C Direction	Use circulating lanes	Junction Delay (s)	Junction LOS
1	Development Access	T-Junction	Two-way	Two-way	Two-way		0.87	A

Junction Network

Driving side	Lighting	Network residual capacity (%)	First arm reaching threshold	Network delay (s)	Network LOS
Left	Normal/unknown	38	Stream B-AC	0.87	A

Traffic Demand

Demand Set Details

ID	Scenario name	Time Period name	Traffic profile type	Start time (HH:mm)	Finish time (HH:mm)	Time segment length (min)	Run automatically	Relationship type	Relationship
D15	2032 Faactored Base + Dev Flows = +5yrs	PM	ONE HOUR	15:00	16:30	15	✓	Simple	D12+D14

Demand overview (Traffic)

Arm	Linked arm	Profile type	Use O-D data	Average Demand (Veh/hr)	Scaling Factor (%)
A		ONE HOUR	✓	561	100.000
B		ONE HOUR	✓	13	100.000
C		ONE HOUR	✓	950	100.000

Origin-Destination Data

Demand (Veh/hr)

		To		
		A	B	C
From	A	0	18	543
	B	5	0	8
	C	888	62	0

Proportions

		To		
		A	B	C
From	A	0.00	0.03	0.97
	B	0.38	0.00	0.62
	C	0.93	0.07	0.00

Vehicle Mix

HV data entry mode	PCU Factor for a HV (PCU)
HV Percentages	2.00

Heavy Vehicle %

		To		
		A	B	C
From	A	0	0	0
	B	0	0	0
	C	0	0	0

Average PCU Per Veh

		To		
		A	B	C
From	A	1.000	1.000	1.000
	B	1.000	1.000	1.000
	C	1.000	1.000	1.000

Detailed Demand Data

Demand for each time segment

Arm	Time Segment	Demand (Veh/hr)	Demand in PCU (PCU/hr)
A	15:00-15:15	422	422
	15:15-15:30	504	504
	15:30-15:45	617	617

	15:45-16:00	617	617
	16:00-16:15	504	504
	16:15-16:30	422	422
B	15:00-15:15	10	10
	15:15-15:30	12	12
	15:30-15:45	14	14
	15:45-16:00	14	14
	16:00-16:15	12	12
	16:15-16:30	10	10
C	15:00-15:15	715	715
	15:15-15:30	854	854
	15:30-15:45	1046	1046
	15:45-16:00	1046	1046
	16:00-16:15	854	854
	16:15-16:30	715	715

Results

Results Summary for whole modelled period

Stream	Max RFC	Max Delay (s)	Max Queue (Veh)	Max 95th percentile Queue (Veh)	Max LOS	Average Demand (Veh/hr)	Total Junction Arrivals (Veh)
B-AC	0.22	14.27	0.3	1.3	B	58	87
C-AB	0.13	8.15	0.2	0.5	A	57	85
C-A						815	1222
A-B						57	85
A-C						498	747

Main Results for each time segment

15:00 - 15:15

Stream	Total Demand (Veh/hr)	Junction Arrivals (Veh)	Capacity (Veh/hr)	RFC	Throughput (Veh/hr)	Start queue (Veh)	End queue (Veh)	Delay (s)	Unsignalised level of service
B-AC	47	12	411	0.116	47	0.0	0.1	9.886	A
C-AB	47	12	558	0.084	46	0.0	0.1	7.037	A
C-A	669	167			669				
A-B	47	12			47				
A-C	408	102			408				

15:15 - 15:30

Stream	Total Demand (Veh/hr)	Junction Arrivals (Veh)	Capacity (Veh/hr)	RFC	Throughput (Veh/hr)	Start queue (Veh)	End queue (Veh)	Delay (s)	Unsignalised level of service
B-AC	57	14	374	0.151	56	0.1	0.2	11.318	B
C-AB	56	14	537	0.104	56	0.1	0.1	7.470	A
C-A	798	200			798				
A-B	56	14			56				
A-C	488	122			488				

15:30 - 15:45

Stream	Total Demand (Veh/hr)	Junction Arrivals (Veh)	Capacity (Veh/hr)	RFC	Throughput (Veh/hr)	Start queue (Veh)	End queue (Veh)	Delay (s)	Unsignalised level of service
B-AC	69	17	322	0.216	69	0.2	0.3	14.231	B
C-AB	68	17	510	0.134	68	0.1	0.2	8.150	A
C-A	978	244			978				
A-B	68	17			68				
A-C	597	149			597				

15:45 - 16:00

Stream	Total Demand (Veh/hr)	Junction Arrivals (Veh)	Capacity (Veh/hr)	RFC	Throughput (Veh/hr)	Start queue (Veh)	End queue (Veh)	Delay (s)	Unsignalised level of service
B-AC	69	17	322	0.216	69	0.3	0.3	14.275	B
C-AB	68	17	510	0.134	68	0.2	0.2	8.154	A
C-A	978	244			978				
A-B	68	17			68				
A-C	597	149			597				

16:00 - 16:15

Stream	Total Demand (Veh/hr)	Junction Arrivals (Veh)	Capacity (Veh/hr)	RFC	Throughput (Veh/hr)	Start queue (Veh)	End queue (Veh)	Delay (s)	Unsignalised level of service
B-AC	57	14	374	0.151	57	0.3	0.2	11.360	B
C-AB	56	14	537	0.104	56	0.2	0.1	7.477	A
C-A	798	200			798				

A-B	56	14			56				
A-C	488	122			488				

16:15 - 16:30

Stream	Total Demand (Veh/hr)	Junction Arrivals (Veh)	Capacity (Veh/hr)	RFC	Throughput (Veh/hr)	Start queue (Veh)	End queue (Veh)	Delay (s)	Unsignalised level of service
B-AC	47	12	410	0.116	48	0.2	0.1	9.929	A
C-AB	47	12	558	0.084	47	0.1	0.1	7.051	A
C-A	669	167			669				
A-B	47	12			47				
A-C	408	102			408				

Queue Variation Results for each time segment**15:00 - 15:15**

Stream	Mean (Veh)	Q05 (Veh)	Q50 (Veh)	Q90 (Veh)	Q95 (Veh)	Percentile message	Marker message	Probability of reaching or exceeding marker	Probability of exactly reaching marker
B-AC	0.13	0.00	0.00	0.13	0.13			N/A	N/A
C-AB	0.09	0.00	0.00	0.09	0.09			N/A	N/A

15:15 - 15:30

Stream	Mean (Veh)	Q05 (Veh)	Q50 (Veh)	Q90 (Veh)	Q95 (Veh)	Percentile message	Marker message	Probability of reaching or exceeding marker	Probability of exactly reaching marker
B-AC	0.18	0.00	0.00	0.18	0.18			N/A	N/A
C-AB	0.11	0.00	0.00	0.11	0.11			N/A	N/A

15:30 - 15:45

Stream	Mean (Veh)	Q05 (Veh)	Q50 (Veh)	Q90 (Veh)	Q95 (Veh)	Percentile message	Marker message	Probability of reaching or exceeding marker	Probability of exactly reaching marker
B-AC	0.27	0.03	0.26	0.47	0.49			N/A	N/A
C-AB	0.15	0.03	0.26	0.46	0.49			N/A	N/A

15:45 - 16:00

Stream	Mean (Veh)	Q05 (Veh)	Q50 (Veh)	Q90 (Veh)	Q95 (Veh)	Percentile message	Marker message	Probability of reaching or exceeding marker	Probability of exactly reaching marker
B-AC	0.27	0.03	0.30	0.96	1.27			N/A	N/A
C-AB	0.15	0.03	0.25	0.45	0.48			N/A	N/A

16:00 - 16:15

Stream	Mean (Veh)	Q05 (Veh)	Q50 (Veh)	Q90 (Veh)	Q95 (Veh)	Percentile message	Marker message	Probability of reaching or exceeding marker	Probability of exactly reaching marker
B-AC	0.18	0.00	0.00	0.18	0.18			N/A	N/A
C-AB	0.12	0.00	0.00	0.12	0.12			N/A	N/A

16:15 - 16:30

Stream	Mean (Veh)	Q05 (Veh)	Q50 (Veh)	Q90 (Veh)	Q95 (Veh)	Percentile message	Marker message	Probability of reaching or exceeding marker	Probability of exactly reaching marker
B-AC	0.13	0.00	0.00	0.13	0.13			N/A	N/A
C-AB	0.09	0.00	0.00	0.09	0.09			N/A	N/A

2042 Faactored Base + 15yrs, PM

Data Errors and Warnings

Severity	Area	Item	Description
Warning	Demand Set Relationship	D4 - 2027 + Development Flows, AM	Demand Set relationships are chained. This may slow down the file.
Warning	Vehicle Mix		HV% is zero for all movements / time segments. Vehicle Mix matrix should be completed whether working in PCUs or Vehs. If HV% at the junction is genuinely zero, please ignore this warning.
Warning	Queue variations	Analysis Options	Queue percentiles may be unreliable if the mean queue in any time segment is very low or very high.

Junction Network

Junctions

Junction	Name	Junction type	Arm A Direction	Arm B Direction	Arm C Direction	Use circulating lanes	Junction Delay (s)	Junction LOS
1	Development Access	T-Junction	Two-way	Two-way	Two-way		0.00	A

Junction Network

Driving side	Lighting	Network residual capacity (%)	First arm reaching threshold	Network delay (s)	Network LOS
Left	Normal/unknown	900		0.00	A

Traffic Demand

Demand Set Details

ID	Scenario name	Time Period name	Traffic profile type	Start time (HH:mm)	Finish time (HH:mm)	Time segment length (min)	Run automatically	Relationship type	Relationship
D16	2042 Faactored Base + 15yrs	PM	ONE HOUR	15:00	16:30	15	✓	Simple	D10*G3

Demand overview (Traffic)

Arm	Linked arm	Profile type	Use O-D data	Average Demand (Veh/hr)	Scaling Factor (%)
A		ONE HOUR	✓	553	100.000
B		ONE HOUR	✓	0	100.000
C		ONE HOUR	✓	906	100.000

Origin-Destination Data

Demand (Veh/hr)

	To			
	A	B	C	
From	A	0	0	553
	B	0	0	0
	C	906	0	0

Proportions

	To			
	A	B	C	
From	A	0.00	0.00	1.00
	B	0.33	0.33	0.33
	C	1.00	0.00	0.00

Vehicle Mix

HV data entry mode	PCU Factor for a HV (PCU)
HV Percentages	2.00

Heavy Vehicle %

	To			
	A	B	C	
From	A	0	0	0
	B	0	0	0
	C	0	0	0

Average PCU Per Veh

	To			
	A	B	C	
From	A	1.000	1.000	1.000
	B	1.000	1.000	1.000
	C	1.000	1.000	1.000

Detailed Demand Data

Demand for each time segment

Arm	Time Segment	Demand (Veh/hr)	Demand in PCU (PCU/hr)
A	15:00-15:15	417	417
	15:15-15:30	497	497
	15:30-15:45	609	609
	15:45-16:00	609	609
	16:00-16:15	497	497

	16:15-16:30	417	417
B	15:00-15:15	0	0
	15:15-15:30	0	0
	15:30-15:45	0	0
	15:45-16:00	0	0
	16:00-16:15	0	0
	16:15-16:30	0	0
C	15:00-15:15	682	682
	15:15-15:30	814	814
	15:30-15:45	997	997
	15:45-16:00	997	997
	16:00-16:15	814	814
	16:15-16:30	682	682

Results

Results Summary for whole modelled period

Stream	Max RFC	Max Delay (s)	Max Queue (Veh)	Max 95th percentile Queue (Veh)	Max LOS	Average Demand (Veh/hr)	Total Junction Arrivals (Veh)
B-AC	0.00	0.00	0.0	~1	A	0	0
C-AB	0.00	0.00	0.0	~1	A	0	0
C-A						831	1247
A-B						0	0
A-C						508	762

Main Results for each time segment

15:00 - 15:15

Stream	Total Demand (Veh/hr)	Junction Arrivals (Veh)	Capacity (Veh/hr)	RFC	Throughput (Veh/hr)	Start queue (Veh)	End queue (Veh)	Delay (s)	Unsignalised level of service
B-AC	0	0	424	0.000	0	0.0	0.0	0.000	A
C-AB	0	0	1133	0.000	0	0.0	0.0	0.000	A
C-A	682	170			682				
A-B	0	0			0				
A-C	417	104			417				

15:15 - 15:30

Stream	Total Demand (Veh/hr)	Junction Arrivals (Veh)	Capacity (Veh/hr)	RFC	Throughput (Veh/hr)	Start queue (Veh)	End queue (Veh)	Delay (s)	Unsignalised level of service
B-AC	0	0	392	0.000	0	0.0	0.0	0.000	A
C-AB	0	0	1096	0.000	0	0.0	0.0	0.000	A
C-A	814	204			814				
A-B	0	0			0				
A-C	497	124			497				

15:30 - 15:45

Stream	Total Demand (Veh/hr)	Junction Arrivals (Veh)	Capacity (Veh/hr)	RFC	Throughput (Veh/hr)	Start queue (Veh)	End queue (Veh)	Delay (s)	Unsignalised level of service
B-AC	0	0	344	0.000	0	0.0	0.0	0.000	A
C-AB	0	0	1045	0.000	0	0.0	0.0	0.000	A
C-A	997	249			997				
A-B	0	0			0				
A-C	609	152			609				

15:45 - 16:00

Stream	Total Demand (Veh/hr)	Junction Arrivals (Veh)	Capacity (Veh/hr)	RFC	Throughput (Veh/hr)	Start queue (Veh)	End queue (Veh)	Delay (s)	Unsignalised level of service
B-AC	0	0	344	0.000	0	0.0	0.0	0.000	A
C-AB	0	0	1045	0.000	0	0.0	0.0	0.000	A
C-A	997	249			997				
A-B	0	0			0				
A-C	609	152			609				

16:00 - 16:15

Stream	Total Demand (Veh/hr)	Junction Arrivals (Veh)	Capacity (Veh/hr)	RFC	Throughput (Veh/hr)	Start queue (Veh)	End queue (Veh)	Delay (s)	Unsignalised level of service
B-AC	0	0	392	0.000	0	0.0	0.0	0.000	A
C-AB	0	0	1096	0.000	0	0.0	0.0	0.000	A
C-A	814	204			814				
A-B	0	0			0				
A-C	497	124			497				

16:15 - 16:30

Stream	Total Demand (Veh/hr)	Junction Arrivals (Veh)	Capacity (Veh/hr)	RFC	Throughput (Veh/hr)	Start queue (Veh)	End queue (Veh)	Delay (s)	Unsignalised level of service
B-AC	0	0	424	0.000	0	0.0	0.0	0.000	A
C-AB	0	0	1133	0.000	0	0.0	0.0	0.000	A
C-A	682	170			682				
A-B	0	0			0				
A-C	417	104			417				

Queue Variation Results for each time segment

15:00 - 15:15

Stream	Mean (Veh)	Q05 (Veh)	Q50 (Veh)	Q90 (Veh)	Q95 (Veh)	Percentile message	Marker message	Probability of reaching or exceeding marker	Probability of exactly reaching marker
B-AC	0.00	0.00	0.00	0.00	0.00			N/A	N/A
C-AB	0.00	0.00	0.00	0.00	0.00			N/A	N/A

15:15 - 15:30

Stream	Mean (Veh)	Q05 (Veh)	Q50 (Veh)	Q90 (Veh)	Q95 (Veh)	Percentile message	Marker message	Probability of reaching or exceeding marker	Probability of exactly reaching marker
B-AC	0.00	0.00	0.00	0.00	0.00			N/A	N/A
C-AB	0.00	0.00	0.00	0.00	0.00			N/A	N/A

15:30 - 15:45

Stream	Mean (Veh)	Q05 (Veh)	Q50 (Veh)	Q90 (Veh)	Q95 (Veh)	Percentile message	Marker message	Probability of reaching or exceeding marker	Probability of exactly reaching marker
B-AC	0.00	0.00	0.00	0.00	0.00			N/A	N/A
C-AB	0.00	0.00	0.00	0.00	0.00			N/A	N/A

15:45 - 16:00

Stream	Mean (Veh)	Q05 (Veh)	Q50 (Veh)	Q90 (Veh)	Q95 (Veh)	Percentile message	Marker message	Probability of reaching or exceeding marker	Probability of exactly reaching marker
B-AC	0.00	0.00	0.00	0.00	0.00			N/A	N/A
C-AB	0.00	0.00	0.00	0.00	0.00			N/A	N/A

16:00 - 16:15

Stream	Mean (Veh)	Q05 (Veh)	Q50 (Veh)	Q90 (Veh)	Q95 (Veh)	Percentile message	Marker message	Probability of reaching or exceeding marker	Probability of exactly reaching marker
B-AC	0.00	0.00	0.00	0.00	0.00			N/A	N/A
C-AB	0.00	0.00	0.00	0.00	0.00			N/A	N/A

16:15 - 16:30

Stream	Mean (Veh)	Q05 (Veh)	Q50 (Veh)	Q90 (Veh)	Q95 (Veh)	Percentile message	Marker message	Probability of reaching or exceeding marker	Probability of exactly reaching marker
B-AC	0.00	0.00	0.00	0.00	0.00			N/A	N/A
C-AB	0.00	0.00	0.00	0.00	0.00			N/A	N/A

2042 Faactored Base + 15yrs + Dev Flows, PM

Data Errors and Warnings

Severity	Area	Item	Description
Warning	Demand Set Relationship	D4 - 2027 + Development Flows, AM	Demand Set relationships are chained. This may slow down the file.
Warning	Vehicle Mix		HV% is zero for all movements / time segments. Vehicle Mix matrix should be completed whether working in PCUs or Vehs. If HV% at the junction is genuinely zero, please ignore this warning.
Warning	Queue variations	Analysis Options	Queue percentiles may be unreliable if the mean queue in any time segment is very low or very high.

Junction Network

Junctions

Junction	Name	Junction type	Arm A Direction	Arm B Direction	Arm C Direction	Use circulating lanes	Junction Delay (s)	Junction LOS
1	Development Access	T-Junction	Two-way	Two-way	Two-way		0.87	A

Junction Network

Driving side	Lighting	Network residual capacity (%)	First arm reaching threshold	Network delay (s)	Network LOS
Left	Normal/unknown	36	Stream B-AC	0.87	A

Traffic Demand

Demand Set Details

ID	Scenario name	Time Period name	Traffic profile type	Start time (HH:mm)	Finish time (HH:mm)	Time segment length (min)	Run automatically	Relationship type	Relationship
D17	2042 Faactored Base + 15yrs + Dev Flows	PM	ONE HOUR	15:00	16:30	15	✓	Simple	D12+D16

Demand overview (Traffic)

Arm	Linked arm	Profile type	Use O-D data	Average Demand (Veh/hr)	Scaling Factor (%)
A		ONE HOUR	✓	571	100.000
B		ONE HOUR	✓	13	100.000
C		ONE HOUR	✓	968	100.000

Origin-Destination Data

Demand (Veh/hr)

		To		
		A	B	C
From	A	0	18	553
	B	5	0	8
	C	906	62	0

Proportions

		To		
		A	B	C
From	A	0.00	0.03	0.97
	B	0.38	0.00	0.62
	C	0.94	0.06	0.00

Vehicle Mix

HV data entry mode	PCU Factor for a HV (PCU)
HV Percentages	2.00

Heavy Vehicle %

		To		
		A	B	C
From	A	0	0	0
	B	0	0	0
	C	0	0	0

Average PCU Per Veh

		To		
		A	B	C
From	A	1.000	1.000	1.000
	B	1.000	1.000	1.000
	C	1.000	1.000	1.000

Detailed Demand Data

Demand for each time segment

Arm	Time Segment	Demand (Veh/hr)	Demand in PCU (PCU/hr)
A	15:00-15:15	430	430
	15:15-15:30	514	514
	15:30-15:45	629	629

	15:45-16:00	629	629
	16:00-16:15	514	514
	16:15-16:30	430	430
B	15:00-15:15	10	10
	15:15-15:30	12	12
	15:30-15:45	14	14
	15:45-16:00	14	14
	16:00-16:15	12	12
	16:15-16:30	10	10
C	15:00-15:15	728	728
	15:15-15:30	870	870
	15:30-15:45	1065	1065
	15:45-16:00	1065	1065
	16:00-16:15	870	870
	16:15-16:30	728	728

Results

Results Summary for whole modelled period

Stream	Max RFC	Max Delay (s)	Max Queue (Veh)	Max 95th percentile Queue (Veh)	Max LOS	Average Demand (Veh/hr)	Total Junction Arrivals (Veh)
B-AC	0.22	14.59	0.3	1.3	B	58	87
C-AB	0.13	8.20	0.2	0.5	A	57	85
C-A						831	1246
A-B						57	85
A-C						508	762

Main Results for each time segment

15:00 - 15:15

Stream	Total Demand (Veh/hr)	Junction Arrivals (Veh)	Capacity (Veh/hr)	RFC	Throughput (Veh/hr)	Start queue (Veh)	End queue (Veh)	Delay (s)	Unsignalised level of service
B-AC	47	12	407	0.116	47	0.0	0.1	9.977	A
C-AB	47	12	556	0.084	46	0.0	0.1	7.063	A
C-A	682	170			682				
A-B	47	12			47				
A-C	417	104			417				

15:15 - 15:30

Stream	Total Demand (Veh/hr)	Junction Arrivals (Veh)	Capacity (Veh/hr)	RFC	Throughput (Veh/hr)	Start queue (Veh)	End queue (Veh)	Delay (s)	Unsignalised level of service
B-AC	57	14	370	0.153	56	0.1	0.2	11.466	B
C-AB	56	14	535	0.104	56	0.1	0.1	7.504	A
C-A	814	204			814				
A-B	56	14			56				
A-C	497	124			497				

15:30 - 15:45

Stream	Total Demand (Veh/hr)	Junction Arrivals (Veh)	Capacity (Veh/hr)	RFC	Throughput (Veh/hr)	Start queue (Veh)	End queue (Veh)	Delay (s)	Unsignalised level of service
B-AC	69	17	316	0.219	69	0.2	0.3	14.538	B
C-AB	68	17	507	0.135	68	0.1	0.2	8.199	A
C-A	997	249			997				
A-B	68	17			68				
A-C	609	152			609				

15:45 - 16:00

Stream	Total Demand (Veh/hr)	Junction Arrivals (Veh)	Capacity (Veh/hr)	RFC	Throughput (Veh/hr)	Start queue (Veh)	End queue (Veh)	Delay (s)	Unsignalised level of service
B-AC	69	17	316	0.219	69	0.3	0.3	14.586	B
C-AB	68	17	507	0.135	68	0.2	0.2	8.204	A
C-A	997	249			997				
A-B	68	17			68				
A-C	609	152			609				

16:00 - 16:15

Stream	Total Demand (Veh/hr)	Junction Arrivals (Veh)	Capacity (Veh/hr)	RFC	Throughput (Veh/hr)	Start queue (Veh)	End queue (Veh)	Delay (s)	Unsignalised level of service
B-AC	57	14	370	0.153	57	0.3	0.2	11.512	B
C-AB	56	14	535	0.104	56	0.2	0.1	7.514	A
C-A	814	204			814				

A-B	56	14			56				
A-C	497	124			497				

16:15 - 16:30

Stream	Total Demand (Veh/hr)	Junction Arrivals (Veh)	Capacity (Veh/hr)	RFC	Throughput (Veh/hr)	Start queue (Veh)	End queue (Veh)	Delay (s)	Unsignalised level of service
B-AC	47	12	407	0.117	48	0.2	0.1	10.018	B
C-AB	47	12	556	0.084	47	0.1	0.1	7.074	A
C-A	682	170			682				
A-B	47	12			47				
A-C	417	104			417				

Queue Variation Results for each time segment**15:00 - 15:15**

Stream	Mean (Veh)	Q05 (Veh)	Q50 (Veh)	Q90 (Veh)	Q95 (Veh)	Percentile message	Marker message	Probability of reaching or exceeding marker	Probability of exactly reaching marker
B-AC	0.13	0.00	0.00	0.13	0.13			N/A	N/A
C-AB	0.09	0.00	0.00	0.09	0.09			N/A	N/A

15:15 - 15:30

Stream	Mean (Veh)	Q05 (Veh)	Q50 (Veh)	Q90 (Veh)	Q95 (Veh)	Percentile message	Marker message	Probability of reaching or exceeding marker	Probability of exactly reaching marker
B-AC	0.18	0.00	0.00	0.18	0.18			N/A	N/A
C-AB	0.12	0.00	0.00	0.12	0.12			N/A	N/A

15:30 - 15:45

Stream	Mean (Veh)	Q05 (Veh)	Q50 (Veh)	Q90 (Veh)	Q95 (Veh)	Percentile message	Marker message	Probability of reaching or exceeding marker	Probability of exactly reaching marker
B-AC	0.28	0.03	0.26	0.47	0.49			N/A	N/A
C-AB	0.15	0.03	0.26	0.46	0.49			N/A	N/A

15:45 - 16:00

Stream	Mean (Veh)	Q05 (Veh)	Q50 (Veh)	Q90 (Veh)	Q95 (Veh)	Percentile message	Marker message	Probability of reaching or exceeding marker	Probability of exactly reaching marker
B-AC	0.28	0.03	0.30	0.98	1.29			N/A	N/A
C-AB	0.15	0.03	0.25	0.45	0.48			N/A	N/A

16:00 - 16:15

Stream	Mean (Veh)	Q05 (Veh)	Q50 (Veh)	Q90 (Veh)	Q95 (Veh)	Percentile message	Marker message	Probability of reaching or exceeding marker	Probability of exactly reaching marker
B-AC	0.18	0.00	0.00	0.18	0.18			N/A	N/A
C-AB	0.12	0.00	0.00	0.12	0.12			N/A	N/A

16:15 - 16:30

Stream	Mean (Veh)	Q05 (Veh)	Q50 (Veh)	Q90 (Veh)	Q95 (Veh)	Percentile message	Marker message	Probability of reaching or exceeding marker	Probability of exactly reaching marker
B-AC	0.13	0.00	0.00	0.13	0.13			N/A	N/A
C-AB	0.09	0.00	0.00	0.09	0.09			N/A	N/A

2042 Faactored Base + 15yrs + Dev Flows x 2, PM

Data Errors and Warnings

Severity	Area	Item	Description
Warning	Demand Set Relationship	D4 - 2027 + Development Flows, AM	Demand Set relationships are chained. This may slow down the file.
Warning	Vehicle Mix		HV% is zero for all movements / time segments. Vehicle Mix matrix should be completed whether working in PCUs or Vehs. If HV% at the junction is genuinely zero, please ignore this warning.
Warning	Queue variations	Analysis Options	Queue percentiles may be unreliable if the mean queue in any time segment is very low or very high.

Junction Network

Junctions

Junction	Name	Junction type	Arm A Direction	Arm B Direction	Arm C Direction	Use circulating lanes	Junction Delay (s)	Junction LOS
1	Development Access	T-Junction	Two-way	Two-way	Two-way		2.33	A

Junction Network

Driving side	Lighting	Network residual capacity (%)	First arm reaching threshold	Network delay (s)	Network LOS
Left	Normal/unknown	10	Stream B-AC	2.33	A

Traffic Demand

Demand Set Details

ID	Scenario name	Time Period name	Traffic profile type	Start time (HH:mm)	Finish time (HH:mm)	Time segment length (min)	Run automatically	Relationship type	Relationship
D18	2042 Faactored Base + 15yrs + Dev Flows x 2	PM	ONE HOUR	15:00	16:30	15	✓	Simple	(D12*2)+D16

Demand overview (Traffic)

Arm	Linked arm	Profile type	Use O-D data	Average Demand (Veh/hr)	Scaling Factor (%)
A		ONE HOUR	✓	589	100.000
B		ONE HOUR	✓	26	100.000
C		ONE HOUR	✓	1030	100.000

Origin-Destination Data

Demand (Veh/hr)

		To		
		A	B	C
From	A	0	36	553
	B	10	0	16
	C	906	124	0

Proportions

		To		
		A	B	C
From	A	0.00	0.06	0.94
	B	0.38	0.00	0.62
	C	0.88	0.12	0.00

Vehicle Mix

HV data entry mode	PCU Factor for a HV (PCU)
HV Percentages	2.00

Heavy Vehicle %

		To		
		A	B	C
From	A	0	0	0
	B	0	0	0
	C	0	0	0

Average PCU Per Veh

		To		
		A	B	C
From	A	1.000	1.000	1.000
	B	1.000	1.000	1.000
	C	1.000	1.000	1.000

Detailed Demand Data

Demand for each time segment

Arm	Time Segment	Demand (Veh/hr)	Demand in PCU (PCU/hr)
A	15:00-15:15	444	444
	15:15-15:30	530	530
	15:30-15:45	649	649

	15:45-16:00	649	649
	16:00-16:15	530	530
	16:15-16:30	444	444
B	15:00-15:15	20	20
	15:15-15:30	23	23
	15:30-15:45	29	29
	15:45-16:00	29	29
	16:00-16:15	23	23
	16:15-16:30	20	20
C	15:00-15:15	775	775
	15:15-15:30	926	926
	15:30-15:45	1134	1134
	15:45-16:00	1134	1134
	16:00-16:15	926	926
	16:15-16:30	775	775

Results

Results Summary for whole modelled period

Stream	Max RFC	Max Delay (s)	Max Queue (Veh)	Max 95th percentile Queue (Veh)	Max LOS	Average Demand (Veh/hr)	Total Junction Arrivals (Veh)
B-AC	0.48	23.98	0.9	4.4	C	116	173
C-AB	0.28	10.03	0.4	1.5	B	114	172
C-A						830	1245
A-B						114	171
A-C						508	762

Main Results for each time segment

15:00 - 15:15

Stream	Total Demand (Veh/hr)	Junction Arrivals (Veh)	Capacity (Veh/hr)	RFC	Throughput (Veh/hr)	Start queue (Veh)	End queue (Veh)	Delay (s)	Unsignalised level of service
B-AC	95	24	391	0.242	94	0.0	0.3	12.046	B
C-AB	93	23	546	0.171	93	0.0	0.2	7.933	A
C-A	682	170			682				
A-B	93	23			93				
A-C	417	104			417				

15:15 - 15:30

Stream	Total Demand (Veh/hr)	Junction Arrivals (Veh)	Capacity (Veh/hr)	RFC	Throughput (Veh/hr)	Start queue (Veh)	End queue (Veh)	Delay (s)	Unsignalised level of service
B-AC	113	28	350	0.324	113	0.3	0.5	15.142	C
C-AB	112	28	524	0.213	112	0.2	0.3	8.721	A
C-A	814	203			814				
A-B	111	28			111				
A-C	497	124			497				

15:30 - 15:45

Stream	Total Demand (Veh/hr)	Junction Arrivals (Veh)	Capacity (Veh/hr)	RFC	Throughput (Veh/hr)	Start queue (Veh)	End queue (Veh)	Delay (s)	Unsignalised level of service
B-AC	139	35	289	0.481	137	0.5	0.9	23.483	C
C-AB	138	35	497	0.278	138	0.3	0.4	10.006	B
C-A	995	249			995				
A-B	137	34			137				
A-C	609	152			609				

15:45 - 16:00

Stream	Total Demand (Veh/hr)	Junction Arrivals (Veh)	Capacity (Veh/hr)	RFC	Throughput (Veh/hr)	Start queue (Veh)	End queue (Veh)	Delay (s)	Unsignalised level of service
B-AC	139	35	289	0.481	139	0.9	0.9	23.978	C
C-AB	138	35	497	0.278	138	0.4	0.4	10.029	B
C-A	995	249			995				
A-B	137	34			137				
A-C	609	152			609				

16:00 - 16:15

Stream	Total Demand (Veh/hr)	Junction Arrivals (Veh)	Capacity (Veh/hr)	RFC	Throughput (Veh/hr)	Start queue (Veh)	End queue (Veh)	Delay (s)	Unsignalised level of service
B-AC	113	28	350	0.324	115	0.9	0.5	15.445	C
C-AB	112	28	524	0.213	112	0.4	0.3	8.752	A
C-A	814	203			814				

A-B	111	28			111				
A-C	497	124			497				

16:15 - 16:30

Stream	Total Demand (Veh/hr)	Junction Arrivals (Veh)	Capacity (Veh/hr)	RFC	Throughput (Veh/hr)	Start queue (Veh)	End queue (Veh)	Delay (s)	Unsignalised level of service
B-AC	95	24	391	0.243	96	0.5	0.3	12.214	B
C-AB	93	23	546	0.171	94	0.3	0.2	7.971	A
C-A	682	170			682				
A-B	93	23			93				
A-C	417	104			417				

Queue Variation Results for each time segment**15:00 - 15:15**

Stream	Mean (Veh)	Q05 (Veh)	Q50 (Veh)	Q90 (Veh)	Q95 (Veh)	Percentile message	Marker message	Probability of reaching or exceeding marker	Probability of exactly reaching marker
B-AC	0.31	0.00	0.00	0.31	0.31			N/A	N/A
C-AB	0.20	0.00	0.00	0.20	0.20			N/A	N/A

15:15 - 15:30

Stream	Mean (Veh)	Q05 (Veh)	Q50 (Veh)	Q90 (Veh)	Q95 (Veh)	Percentile message	Marker message	Probability of reaching or exceeding marker	Probability of exactly reaching marker
B-AC	0.47	0.00	0.00	0.47	0.47			N/A	N/A
C-AB	0.27	0.00	0.00	0.27	0.27			N/A	N/A

15:30 - 15:45

Stream	Mean (Veh)	Q05 (Veh)	Q50 (Veh)	Q90 (Veh)	Q95 (Veh)	Percentile message	Marker message	Probability of reaching or exceeding marker	Probability of exactly reaching marker
B-AC	0.88	0.03	0.27	0.88	1.54			N/A	N/A
C-AB	0.38	0.03	0.26	0.46	0.49			N/A	N/A

15:45 - 16:00

Stream	Mean (Veh)	Q05 (Veh)	Q50 (Veh)	Q90 (Veh)	Q95 (Veh)	Percentile message	Marker message	Probability of reaching or exceeding marker	Probability of exactly reaching marker
B-AC	0.90	0.03	0.30	1.34	4.41			N/A	N/A
C-AB	0.39	0.03	0.31	1.27	1.49			N/A	N/A

16:00 - 16:15

Stream	Mean (Veh)	Q05 (Veh)	Q50 (Veh)	Q90 (Veh)	Q95 (Veh)	Percentile message	Marker message	Probability of reaching or exceeding marker	Probability of exactly reaching marker
B-AC	0.49	0.04	0.43	1.27	1.39			N/A	N/A
C-AB	0.28	0.00	0.00	0.28	0.28			N/A	N/A

16:15 - 16:30

Stream	Mean (Veh)	Q05 (Veh)	Q50 (Veh)	Q90 (Veh)	Q95 (Veh)	Percentile message	Marker message	Probability of reaching or exceeding marker	Probability of exactly reaching marker
B-AC	0.33	0.03	0.31	0.97	1.24			N/A	N/A
C-AB	0.21	0.00	0.00	0.21	0.21			N/A	N/A

<h1>Junctions 10</h1>
PICADY 10 - Priority Intersection Module
Version: 10.1.0.1820 © Copyright TRL Software Limited, 2023
For sales and distribution information, program advice and maintenance, contact TRL Software: +44 (0)1344 379777 software@trl.co.uk trlsoftware.com
The users of this computer program for the solution of an engineering problem are in no way relieved of their responsibility for the correctness of the solution

Filename: 240304_Site_Access_All_Traffic.j10
 Path: C:\Users\MartinHoy\Hoy & Dorman Ltd\Hoy Dorman - Documents\Civils\2023001_Cavan_Sports_Facility\2.0 Work\2.2 Traffic
 Report generation date: 06/03/2024 13:25:17

- »2023, AM
- »2027 - Opening Year, AM
- »Development Flows, AM
- »2027 + Development Flows, AM
- »2032 Faactored Base + 5yrs, AM
- »2032 Faactored Base + Dev Flows = +5yrs, AM
- »2042 Faactored Base + 15yrs, AM
- »2042 Faactored Base + 15yrs + Dev Flows, AM
- »2042 Faactored Base + 15yrs + Dev Flows x 2, AM
- »2023, PM
- »2027 - Opening Year, PM
- »Development Flows, PM
- »2027 + Development Flows, PM
- »2032 Faactored Base + 5yrs, PM
- »2032 Faactored Base + Dev Flows = +5yrs, PM
- »2042 Faactored Base + 15yrs, PM
- »2042 Faactored Base + 15yrs + Dev Flows, PM
- »2042 Faactored Base + 15yrs + Dev Flows x 2, PM

Summary of junction performance

	AM									PM								
	Set ID	Queue (Veh)	95% Queue (Veh)	Delay (s)	RFC	LOS	Junction Delay (s)	Junction LOS	Network Residual Capacity	Set ID	Queue (Veh)	95% Queue (Veh)	Delay (s)	RFC	LOS	Junction Delay (s)	Junction LOS	Network Residual Capacity
2023																		
Stream B-AC	D1	0.0	~1	0.00	0.00	A	0.00	A	900 %	D10	0.0	~1	0.00	0.00	A	0.00	A	900 %
Stream C-AB		0.0	~1	0.00	0.00	A					0.0	~1	0.00	0.00	A			
2027 - Opening Year																		
Stream B-AC	D2	0.0	~1	0.00	0.00	A	0.00	A	900 %	D11	0.0	~1	0.00	0.00	A	0.00	A	900 %
Stream C-AB		0.0	~1	0.00	0.00	A					0.0	~1	0.00	0.00	A			
Development Flows																		
Stream B-AC	D3	0.2	0.8	7.89	0.17	A	5.22	A	314 % [Stream B-AC]	D12	0.1	0.5	7.32	0.12	A	4.53	A	435 % [Stream B-AC]
Stream C-AB		0.1	0.5	6.14	0.10	A					0.1	0.5	6.23	0.11	A			
2027 + Development Flows																		
Stream B-AC	D4	0.3	1.5	12.75	0.25	B	1.27	A	58 % [Stream B-AC]	D13	0.3	1.2	13.81	0.21	B	0.87	A	41 % [Stream B-AC]
Stream C-AB		0.1	0.5	7.57	0.11	A					0.2	0.5	8.08	0.13	A			
2032 Faactored Base + 5yrs																		
Stream B-AC	D5	0.0	~1	0.00	0.00	A	0.00	A	900 %	D14	0.0	~1	0.00	0.00	A	0.00	A	900 %
Stream C-AB		0.0	~1	0.00	0.00	A					0.0	~1	0.00	0.00	A			
2032 Faactored Base + Dev Flows = +5yrs																		
Stream B-AC	D6	0.3	1.0	13.02	0.26	B	1.26	A	55 % [Stream B-AC]	D15	0.3	1.3	14.27	0.22	B	0.87	A	38 % [Stream B-AC]
Stream C-AB		0.1	0.5	7.63	0.12	A					0.2	0.5	8.15	0.13	A			
2042 Faactored Base + 15yrs																		
Stream B-AC	D7	0.0	~1	0.00	0.00	A	0.00	A	900 %	D16	0.0	~1	0.00	0.00	A	0.00	A	900 %
Stream C-AB		0.0	~1	0.00	0.00	A					0.0	~1	0.00	0.00	A			
2042 Faactored Base + 15yrs + Dev Flows																		
Stream B-AC	D8	0.3	1.1	13.20	0.26	B	1.26	A	53 % [Stream B-AC]	D17	0.3	1.3	14.59	0.22	B	0.87	A	36 % [Stream B-AC]
Stream C-AB		0.1	0.5	7.66	0.12	A					0.2	0.5	8.20	0.13	A			
2042 Faactored Base + 15yrs + Dev Flows x 2																		
									12 %									
									10 %									

Stream B-AC	D9	1.2	5.2	23.09	0.55	C	3.46	A	[Stream B-AC]	D18	0.9	4.4	23.98	0.48	C	2.33	A	[Stream B-AC]
Stream C-AB		0.3	1.4	9.09	0.24	A					0.4	1.5	10.03	0.28	B			

There are warnings associated with one or more model runs - see the 'Data Errors and Warnings' tables for each Analysis or Demand Set.

Values shown are the highest values encountered over all time segments. Delay is the maximum value of average delay per arriving vehicle. Junction LOS and Junction Delay are demand-weighted averages. Network Residual Capacity indicates the amount by which network flow could be increased before a user-definable threshold (see Analysis Options) is met.

File summary

File Description

Title	
Location	
Site number	
Date	07/11/2023
Version	
Status	(new file)
Identifier	
Client	
Jobnumber	
Enumerator	AzureAD\MartinHoy
Description	

Units

Distance units	Speed units	Traffic units input	Traffic units results	Flow units	Average delay units	Total delay units	Rate of delay units
m	kph	Veh	Veh	perHour	s	-Min	perMin

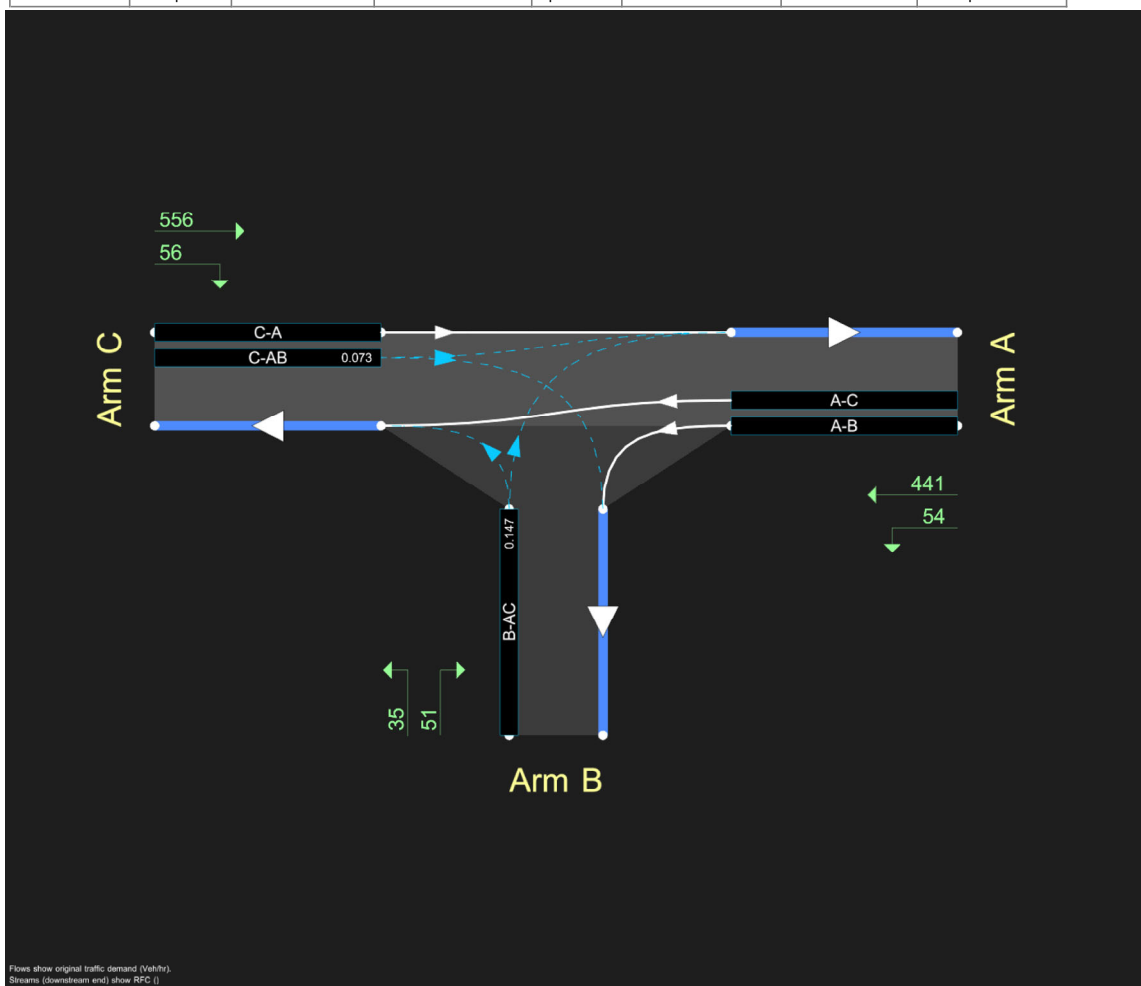

The junction diagram reflects the last run of Junctions.

Analysis Options

Vehicle length (m)	Calculate Queue Percentiles	Calculate detailed queueing delay	Show lane queues in feet / metres	Show all PICADY stream intercepts	Calculate residual capacity	Residual capacity criteria type	RFC Threshold	Average Delay threshold (s)	Queue threshold (PCU)	Use iterations with HCM roundabouts	Max number of iterations for roundabouts
5.75	✓				✓	Delay	0.85	36.00	20.00		500

Demand Set Summary

--	--	--	--	--	--	--	--	--	--	--	--

ID	Scenario name	Time Period name	Traffic profile type	Start time (HH:mm)	Finish time (HH:mm)	Time segment length (min)	Run automatically	Relationship type	Relationship
D1	2023	AM	ONE HOUR	09:00	10:30	15	✓		
D2	2027 - Opening Year	AM	ONE HOUR	09:00	10:30	15	✓	Simple	D1*G1
D3	Development Flows	AM	ONE HOUR	09:00	10:30	15	✓		
D4	2027 + Development Flows	AM	ONE HOUR	09:00	10:30	15	✓	Simple	D2+D3
D5	2032 Faactored Base + 5yrs	AM	ONE HOUR	09:00	10:30	15	✓	Simple	D1*G2
D6	2032 Faactored Base + Dev Flows = +5yrs	AM	ONE HOUR	09:00	10:30	15	✓	Simple	D3+D5
D7	2042 Faactored Base + 15yrs	AM	ONE HOUR	09:00	10:30	15	✓	Simple	D1*G3
D8	2042 Faactored Base + 15yrs + Dev Flows	AM	ONE HOUR	09:00	10:30	15	✓	Simple	D3+D7
D9	2042 Faactored Base + 15yrs + Dev Flows x 2	AM	ONE HOUR	09:00	10:30	15	✓	Simple	(D3*2)+D7
D10	2023	PM	ONE HOUR	15:00	16:30	15	✓		
D11	2027 - Opening Year	PM	ONE HOUR	15:00	16:30	15	✓	Simple	D10*G1
D12	Development Flows	PM	ONE HOUR	15:00	16:30	15	✓		
D13	2027 + Development Flows	PM	ONE HOUR	15:00	16:30	15	✓	Simple	D11+D12
D14	2032 Faactored Base + 5yrs	PM	ONE HOUR	15:00	16:30	15	✓	Simple	D10*G2
D15	2032 Faactored Base + Dev Flows = +5yrs	PM	ONE HOUR	15:00	16:30	15	✓	Simple	D12+D14
D16	2042 Faactored Base + 15yrs	PM	ONE HOUR	15:00	16:30	15	✓	Simple	D10*G3
D17	2042 Faactored Base + 15yrs + Dev Flows	PM	ONE HOUR	15:00	16:30	15	✓	Simple	D12+D16
D18	2042 Faactored Base + 15yrs + Dev Flows x 2	PM	ONE HOUR	15:00	16:30	15	✓	Simple	(D12*2)+D16

Growth Factors

ID	Description	Use TEMPRO	Growth Factor
G1			1.0490
G2			1.0830
G3			1.1044

Growth factors are only active if the Demand Set references them in a Relationship.

Analysis Set Details

ID	Include in report	Network flow scaling factor (%)	Network capacity scaling factor (%)
A1	✓	100.000	100.000

2023, AM

Data Errors and Warnings

Severity	Area	Item	Description
Warning	Demand Set Relationship	D4 - 2027 + Development Flows, AM	Demand Set relationships are chained. This may slow down the file.
Warning	Vehicle Mix		HV% is zero for all movements / time segments. Vehicle Mix matrix should be completed whether working in PCUs or Vehs. If HV% at the junction is genuinely zero, please ignore this warning.
Warning	Queue variations	Analysis Options	Queue percentiles may be unreliable if the mean queue in any time segment is very low or very high.

Junction Network

Junctions

Junction	Name	Junction type	Arm A Direction	Arm B Direction	Arm C Direction	Use circulating lanes	Junction Delay (s)	Junction LOS
1	Development Access	T-Junction	Two-way	Two-way	Two-way		0.00	A

Junction Network

Driving side	Lighting	Network residual capacity (%)	First arm reaching threshold	Network delay (s)	Network LOS
Left	Normal/unknown	900		0.00	A

Arms

Arms

Arm	Name	Description	Arm type
A	untitled		Major
B	untitled		Minor
C	untitled		Major

Major Arm Geometry

Arm	Width of carriageway (m)	Has kerbed central reserve	Has right-turn storage	Width for right-turn storage (m)	Visibility for right turn (m)	Blocks?	Blocking queue (PCU)
C	8.50		✓	2.50	115.0	✓	4.00

Geometries for Arm C are measured opposite Arm B. Geometries for Arm A (if relevant) are measured opposite Arm D.

Minor Arm Geometry

Arm	Minor arm type	Lane width (m)	Visibility to left (m)	Visibility to right (m)
B	One lane	3.00	77	44

Slope / Intercept / Capacity

Priority Intersection Slopes and Intercepts

Stream	Intercept (Veh/hr)	Slope for A-B	Slope for A-C	Slope for C-A	Slope for C-B
B-A	524	0.085	0.215	0.135	0.307
B-C	652	0.089	0.225	-	-
C-B	661	0.228	0.228	-	-

The slopes and intercepts shown above include custom intercept adjustments only.

Streams may be combined, in which case capacity will be adjusted.

Values are shown for the first time segment only; they may differ for subsequent time segments.

Traffic Demand

Demand Set Details

ID	Scenario name	Time Period name	Traffic profile type	Start time (HH:mm)	Finish time (HH:mm)	Time segment length (min)	Run automatically
D1	2023	AM	ONE HOUR	09:00	10:30	15	✓

Demand overview (Traffic)

Arm	Linked arm	Profile type	Use O-D data	Average Demand (Veh/hr)	Scaling Factor (%)
A		ONE HOUR	✓	420	100.000
B		ONE HOUR	✓	0	100.000
C		ONE HOUR	✓	530	100.000

Origin-Destination Data

Demand (Veh/hr)

		To			
		A	B	C	
From	A	0	0	420	
	B	0	0	0	
	C	530	0	0	

Proportions

		To			
		A	B	C	
From	A	0.00	0.00	1.00	
	B	0.33	0.33	0.33	
	C	1.00	0.00	0.00	

Vehicle Mix

HV data entry mode	PCU Factor for a HV (PCU)
HV Percentages	2.00

Heavy Vehicle %

		To			
		A	B	C	
From	A	0	0	0	
	B	0	0	0	
	C	0	0	0	

Average PCU Per Veh

		To			
		A	B	C	
From	A	1.000	1.000	1.000	
	B	1.000	1.000	1.000	
	C	1.000	1.000	1.000	

Detailed Demand Data

Demand for each time segment

Arm	Time Segment	Demand (Veh/hr)	Demand in PCU (PCU/hr)
A	09:00-09:15	316	316
	09:15-09:30	378	378
	09:30-09:45	462	462
	09:45-10:00	462	462
	10:00-10:15	378	378
	10:15-10:30	316	316
B	09:00-09:15	0	0
	09:15-09:30	0	0
	09:30-09:45	0	0
	09:45-10:00	0	0
	10:00-10:15	0	0
	10:15-10:30	0	0
C	09:00-09:15	399	399
	09:15-09:30	476	476
	09:30-09:45	584	584
	09:45-10:00	584	584
	10:00-10:15	476	476
	10:15-10:30	399	399

Results

Results Summary for whole modelled period

Stream	Max RFC	Max Delay (s)	Max Queue (Veh)	Max 95th percentile Queue (Veh)	Max LOS	Average Demand (Veh/hr)	Total Junction Arrivals (Veh)
B-AC	0.00	0.00	0.0	~1	A	0	0
C-AB	0.00	0.00	0.0	~1	A	0	0
C-A						486	730
A-B						0	0
A-C						385	578

Main Results for each time segment

09:00 - 09:15

Stream	Total Demand (Veh/hr)	Junction Arrivals (Veh)	Capacity (Veh/hr)	RFC	Throughput (Veh/hr)	Start queue (Veh)	End queue (Veh)	Delay (s)	Unsignalised level of service
B-AC	0	0	475	0.000	0	0.0	0.0	0.000	A
C-AB	0	0	1179	0.000	0	0.0	0.0	0.000	A
C-A	399	100			399				
A-B	0	0			0				
A-C	316	79			316				

09:15 - 09:30

--	--	--	--	--	--	--	--	--	--

Stream	Total Demand (Veh/hr)	Junction Arrivals (Veh)	Capacity (Veh/hr)	RFC	Throughput (Veh/hr)	Start queue (Veh)	End queue (Veh)	Delay (s)	Unsignalised level of service
B-AC	0	0	454	0.000	0	0.0	0.0	0.000	A
C-AB	0	0	1150	0.000	0	0.0	0.0	0.000	A
C-A	476	119			476				
A-B	0	0			0				
A-C	378	94			378				

09:30 - 09:45

Stream	Total Demand (Veh/hr)	Junction Arrivals (Veh)	Capacity (Veh/hr)	RFC	Throughput (Veh/hr)	Start queue (Veh)	End queue (Veh)	Delay (s)	Unsignalised level of service
B-AC	0	0	424	0.000	0	0.0	0.0	0.000	A
C-AB	0	0	1112	0.000	0	0.0	0.0	0.000	A
C-A	584	146			584				
A-B	0	0			0				
A-C	462	116			462				

09:45 - 10:00

Stream	Total Demand (Veh/hr)	Junction Arrivals (Veh)	Capacity (Veh/hr)	RFC	Throughput (Veh/hr)	Start queue (Veh)	End queue (Veh)	Delay (s)	Unsignalised level of service
B-AC	0	0	424	0.000	0	0.0	0.0	0.000	A
C-AB	0	0	1112	0.000	0	0.0	0.0	0.000	A
C-A	584	146			584				
A-B	0	0			0				
A-C	462	116			462				

10:00 - 10:15

Stream	Total Demand (Veh/hr)	Junction Arrivals (Veh)	Capacity (Veh/hr)	RFC	Throughput (Veh/hr)	Start queue (Veh)	End queue (Veh)	Delay (s)	Unsignalised level of service
B-AC	0	0	454	0.000	0	0.0	0.0	0.000	A
C-AB	0	0	1150	0.000	0	0.0	0.0	0.000	A
C-A	476	119			476				
A-B	0	0			0				
A-C	378	94			378				

10:15 - 10:30

Stream	Total Demand (Veh/hr)	Junction Arrivals (Veh)	Capacity (Veh/hr)	RFC	Throughput (Veh/hr)	Start queue (Veh)	End queue (Veh)	Delay (s)	Unsignalised level of service
B-AC	0	0	475	0.000	0	0.0	0.0	0.000	A
C-AB	0	0	1179	0.000	0	0.0	0.0	0.000	A
C-A	399	100			399				
A-B	0	0			0				
A-C	316	79			316				

Queue Variation Results for each time segment

09:00 - 09:15

Stream	Mean (Veh)	Q05 (Veh)	Q50 (Veh)	Q90 (Veh)	Q95 (Veh)	Percentile message	Marker message	Probability of reaching or exceeding marker	Probability of exactly reaching marker
B-AC	0.00	0.00	0.00	0.00	0.00			N/A	N/A
C-AB	0.00	0.00	0.00	0.00	0.00			N/A	N/A

09:15 - 09:30

Stream	Mean (Veh)	Q05 (Veh)	Q50 (Veh)	Q90 (Veh)	Q95 (Veh)	Percentile message	Marker message	Probability of reaching or exceeding marker	Probability of exactly reaching marker
B-AC	0.00	0.00	0.00	0.00	0.00			N/A	N/A
C-AB	0.00	0.00	0.00	0.00	0.00			N/A	N/A

09:30 - 09:45

Stream	Mean (Veh)	Q05 (Veh)	Q50 (Veh)	Q90 (Veh)	Q95 (Veh)	Percentile message	Marker message	Probability of reaching or exceeding marker	Probability of exactly reaching marker
B-AC	0.00	0.00	0.00	0.00	0.00			N/A	N/A
C-AB	0.00	0.00	0.00	0.00	0.00			N/A	N/A

09:45 - 10:00

Stream	Mean (Veh)	Q05 (Veh)	Q50 (Veh)	Q90 (Veh)	Q95 (Veh)	Percentile message	Marker message	Probability of reaching or exceeding marker	Probability of exactly reaching marker
B-AC	0.00	0.00	0.00	0.00	0.00			N/A	N/A
C-AB	0.00	0.00	0.00	0.00	0.00			N/A	N/A

10:00 - 10:15

Stream	Mean (Veh)	Q05 (Veh)	Q50 (Veh)	Q90 (Veh)	Q95 (Veh)	Percentile message	Marker message	Probability of reaching or exceeding marker	Probability of exactly reaching marker
B-AC	0.00	0.00	0.00	0.00	0.00			N/A	N/A
C-AB	0.00	0.00	0.00	0.00	0.00			N/A	N/A

10:15 - 10:30

Stream	Mean (Veh)	Q05 (Veh)	Q50 (Veh)	Q90 (Veh)	Q95 (Veh)	Percentile message	Marker message	Probability of reaching or exceeding marker	Probability of exactly reaching marker
B-AC	0.00	0.00	0.00	0.00	0.00			N/A	N/A
C-AB	0.00	0.00	0.00	0.00	0.00			N/A	N/A

2027 - Opening Year, AM

Data Errors and Warnings

Severity	Area	Item	Description
Warning	Demand Set Relationship	D4 - 2027 + Development Flows, AM	Demand Set relationships are chained. This may slow down the file.
Warning	Vehicle Mix		HV% is zero for all movements / time segments. Vehicle Mix matrix should be completed whether working in PCUs or Vehs. If HV% at the junction is genuinely zero, please ignore this warning.
Warning	Queue variations	Analysis Options	Queue percentiles may be unreliable if the mean queue in any time segment is very low or very high.

Junction Network

Junctions

Junction	Name	Junction type	Arm A Direction	Arm B Direction	Arm C Direction	Use circulating lanes	Junction Delay (s)	Junction LOS
1	Development Access	T-Junction	Two-way	Two-way	Two-way		0.00	A

Junction Network

Driving side	Lighting	Network residual capacity (%)	First arm reaching threshold	Network delay (s)	Network LOS
Left	Normal/unknown	900		0.00	A

Traffic Demand

Demand Set Details

ID	Scenario name	Time Period name	Traffic profile type	Start time (HH:mm)	Finish time (HH:mm)	Time segment length (min)	Run automatically	Relationship type	Relationship
D2	2027 - Opening Year	AM	ONE HOUR	09:00	10:30	15	✓	Simple	D1*G1

Demand overview (Traffic)

Arm	Linked arm	Profile type	Use O-D data	Average Demand (Veh/hr)	Scaling Factor (%)
A		ONE HOUR	✓	441	100.000
B		ONE HOUR	✓	0	100.000
C		ONE HOUR	✓	556	100.000

Origin-Destination Data

Demand (Veh/hr)

	To			
	A	B	C	
From	A	0	0	441
	B	0	0	0
	C	556	0	0

Proportions

	To			
	A	B	C	
From	A	0.00	0.00	1.00
	B	0.33	0.33	0.33
	C	1.00	0.00	0.00

Vehicle Mix

HV data entry mode	PCU Factor for a HV (PCU)
HV Percentages	2.00

Heavy Vehicle %

	To			
	A	B	C	
From	A	0	0	0
	B	0	0	0
	C	0	0	0

Average PCU Per Veh

	To			
	A	B	C	
From	A	1.000	1.000	1.000
	B	1.000	1.000	1.000
	C	1.000	1.000	1.000

Detailed Demand Data

Demand for each time segment

Arm	Time Segment	Demand (Veh/hr)	Demand in PCU (PCU/hr)
A	09:00-09:15	332	332
	09:15-09:30	396	396
	09:30-09:45	485	485
	09:45-10:00	485	485
	10:00-10:15	396	396

	10:15-10:30	332	332
B	09:00-09:15	0	0
	09:15-09:30	0	0
	09:30-09:45	0	0
	09:45-10:00	0	0
	10:00-10:15	0	0
	10:15-10:30	0	0
C	09:00-09:15	419	419
	09:15-09:30	500	500
	09:30-09:45	612	612
	09:45-10:00	612	612
	10:00-10:15	500	500
	10:15-10:30	419	419

Results

Results Summary for whole modelled period

Stream	Max RFC	Max Delay (s)	Max Queue (Veh)	Max 95th percentile Queue (Veh)	Max LOS	Average Demand (Veh/hr)	Total Junction Arrivals (Veh)
B-AC	0.00	0.00	0.0	~1	A	0	0
C-AB	0.00	0.00	0.0	~1	A	0	0
C-A						510	765
A-B						0	0
A-C						404	606

Main Results for each time segment

09:00 - 09:15

Stream	Total Demand (Veh/hr)	Junction Arrivals (Veh)	Capacity (Veh/hr)	RFC	Throughput (Veh/hr)	Start queue (Veh)	End queue (Veh)	Delay (s)	Unsignalised level of service
B-AC	0	0	470	0.000	0	0.0	0.0	0.000	A
C-AB	0	0	1171	0.000	0	0.0	0.0	0.000	A
C-A	419	105			419				
A-B	0	0			0				
A-C	332	83			332				

09:15 - 09:30

Stream	Total Demand (Veh/hr)	Junction Arrivals (Veh)	Capacity (Veh/hr)	RFC	Throughput (Veh/hr)	Start queue (Veh)	End queue (Veh)	Delay (s)	Unsignalised level of service
B-AC	0	0	447	0.000	0	0.0	0.0	0.000	A
C-AB	0	0	1142	0.000	0	0.0	0.0	0.000	A
C-A	500	125			500				
A-B	0	0			0				
A-C	396	99			396				

09:30 - 09:45

Stream	Total Demand (Veh/hr)	Junction Arrivals (Veh)	Capacity (Veh/hr)	RFC	Throughput (Veh/hr)	Start queue (Veh)	End queue (Veh)	Delay (s)	Unsignalised level of service
B-AC	0	0	416	0.000	0	0.0	0.0	0.000	A
C-AB	0	0	1101	0.000	0	0.0	0.0	0.000	A
C-A	612	153			612				
A-B	0	0			0				
A-C	485	121			485				

09:45 - 10:00

Stream	Total Demand (Veh/hr)	Junction Arrivals (Veh)	Capacity (Veh/hr)	RFC	Throughput (Veh/hr)	Start queue (Veh)	End queue (Veh)	Delay (s)	Unsignalised level of service
B-AC	0	0	416	0.000	0	0.0	0.0	0.000	A
C-AB	0	0	1101	0.000	0	0.0	0.0	0.000	A
C-A	612	153			612				
A-B	0	0			0				
A-C	485	121			485				

10:00 - 10:15

Stream	Total Demand (Veh/hr)	Junction Arrivals (Veh)	Capacity (Veh/hr)	RFC	Throughput (Veh/hr)	Start queue (Veh)	End queue (Veh)	Delay (s)	Unsignalised level of service
B-AC	0	0	447	0.000	0	0.0	0.0	0.000	A
C-AB	0	0	1142	0.000	0	0.0	0.0	0.000	A
C-A	500	125			500				
A-B	0	0			0				
A-C	396	99			396				

10:15 - 10:30

Stream	Total Demand (Veh/hr)	Junction Arrivals (Veh)	Capacity (Veh/hr)	RFC	Throughput (Veh/hr)	Start queue (Veh)	End queue (Veh)	Delay (s)	Unsignalised level of service
B-AC	0	0	470	0.000	0	0.0	0.0	0.000	A
C-AB	0	0	1171	0.000	0	0.0	0.0	0.000	A
C-A	419	105			419				
A-B	0	0			0				
A-C	332	83			332				

Queue Variation Results for each time segment**09:00 - 09:15**

Stream	Mean (Veh)	Q05 (Veh)	Q50 (Veh)	Q90 (Veh)	Q95 (Veh)	Percentile message	Marker message	Probability of reaching or exceeding marker	Probability of exactly reaching marker
B-AC	0.00	0.00	0.00	0.00	0.00			N/A	N/A
C-AB	0.00	0.00	0.00	0.00	0.00			N/A	N/A

09:15 - 09:30

Stream	Mean (Veh)	Q05 (Veh)	Q50 (Veh)	Q90 (Veh)	Q95 (Veh)	Percentile message	Marker message	Probability of reaching or exceeding marker	Probability of exactly reaching marker
B-AC	0.00	0.00	0.00	0.00	0.00			N/A	N/A
C-AB	0.00	0.00	0.00	0.00	0.00			N/A	N/A

09:30 - 09:45

Stream	Mean (Veh)	Q05 (Veh)	Q50 (Veh)	Q90 (Veh)	Q95 (Veh)	Percentile message	Marker message	Probability of reaching or exceeding marker	Probability of exactly reaching marker
B-AC	0.00	0.00	0.00	0.00	0.00			N/A	N/A
C-AB	0.00	0.00	0.00	0.00	0.00			N/A	N/A

09:45 - 10:00

Stream	Mean (Veh)	Q05 (Veh)	Q50 (Veh)	Q90 (Veh)	Q95 (Veh)	Percentile message	Marker message	Probability of reaching or exceeding marker	Probability of exactly reaching marker
B-AC	0.00	0.00	0.00	0.00	0.00			N/A	N/A
C-AB	0.00	0.00	0.00	0.00	0.00			N/A	N/A

10:00 - 10:15

Stream	Mean (Veh)	Q05 (Veh)	Q50 (Veh)	Q90 (Veh)	Q95 (Veh)	Percentile message	Marker message	Probability of reaching or exceeding marker	Probability of exactly reaching marker
B-AC	0.00	0.00	0.00	0.00	0.00			N/A	N/A
C-AB	0.00	0.00	0.00	0.00	0.00			N/A	N/A

10:15 - 10:30

Stream	Mean (Veh)	Q05 (Veh)	Q50 (Veh)	Q90 (Veh)	Q95 (Veh)	Percentile message	Marker message	Probability of reaching or exceeding marker	Probability of exactly reaching marker
B-AC	0.00	0.00	0.00	0.00	0.00			N/A	N/A
C-AB	0.00	0.00	0.00	0.00	0.00			N/A	N/A

Development Flows, AM

Data Errors and Warnings

Severity	Area	Item	Description
Warning	Demand Set Relationship	D4 - 2027 + Development Flows, AM	Demand Set relationships are chained. This may slow down the file.
Warning	Vehicle Mix		HV% is zero for all movements / time segments. Vehicle Mix matrix should be completed whether working in PCUs or Vehs. If HV% at the junction is genuinely zero, please ignore this warning.
Warning	Queue variations	Analysis Options	Queue percentiles may be unreliable if the mean queue in any time segment is very low or very high.

Junction Network

Junctions

Junction	Name	Junction type	Arm A Direction	Arm B Direction	Arm C Direction	Use circulating lanes	Junction Delay (s)	Junction LOS
1	Development Access	T-Junction	Two-way	Two-way	Two-way		5.22	A

Junction Network

Driving side	Lighting	Network residual capacity (%)	First arm reaching threshold	Network delay (s)	Network LOS
Left	Normal/unknown	314	Stream B-AC	5.22	A

Traffic Demand

Demand Set Details

ID	Scenario name	Time Period name	Traffic profile type	Start time (HH:mm)	Finish time (HH:mm)	Time segment length (min)	Run automatically
D3	Development Flows	AM	ONE HOUR	09:00	10:30	15	✓

Demand overview (Traffic)

Arm	Linked arm	Profile type	Use O-D data	Average Demand (Veh/hr)	Scaling Factor (%)
A		ONE HOUR	✓	54	100.000
B		ONE HOUR	✓	86	100.000
C		ONE HOUR	✓	56	100.000

Origin-Destination Data

Demand (Veh/hr)

		To		
		A	B	C
From	A	0	54	0
	B	51	0	35
	C	0	56	0

Proportions

		To		
		A	B	C
From	A	0.00	1.00	0.00
	B	0.59	0.00	0.41
	C	0.00	1.00	0.00

Vehicle Mix

HV data entry mode	PCU Factor for a HV (PCU)
HV Percentages	2.00

Heavy Vehicle %

		To		
		A	B	C
From	A	0	0	0
	B	0	0	0
	C	0	0	0

Average PCU Per Veh

		To		
		A	B	C
From	A	1.000	1.000	1.000
	B	1.000	1.000	1.000
	C	1.000	1.000	1.000

Detailed Demand Data

Demand for each time segment

Arm	Time Segment	Demand (Veh/hr)	Demand in PCU (PCU/hr)
A	09:00-09:15	41	41
	09:15-09:30	49	49
	09:30-09:45	59	59
	09:45-10:00	59	59
	10:00-10:15	49	49

	10:15-10:30	41	41
B	09:00-09:15	65	65
	09:15-09:30	77	77
	09:30-09:45	95	95
	09:45-10:00	95	95
	10:00-10:15	77	77
	10:15-10:30	65	65
C	09:00-09:15	42	42
	09:15-09:30	50	50
	09:30-09:45	62	62
	09:45-10:00	62	62
	10:00-10:15	50	50
	10:15-10:30	42	42

Results

Results Summary for whole modelled period

Stream	Max RFC	Max Delay (s)	Max Queue (Veh)	Max 95th percentile Queue (Veh)	Max LOS	Average Demand (Veh/hr)	Total Junction Arrivals (Veh)
B-AC	0.17	7.89	0.2	0.8	A	79	118
C-AB	0.10	6.14	0.1	0.5	A	51	77
C-A						0	0
A-B						50	74
A-C						0	0

Main Results for each time segment

09:00 - 09:15

Stream	Total Demand (Veh/hr)	Junction Arrivals (Veh)	Capacity (Veh/hr)	RFC	Throughput (Veh/hr)	Start queue (Veh)	End queue (Veh)	Delay (s)	Unsignalised level of service
B-AC	65	16	557	0.116	64	0.0	0.1	7.298	A
C-AB	42	11	652	0.065	42	0.0	0.1	5.896	A
C-A	0	0			0				
A-B	41	10			41				
A-C	0	0			0				

09:15 - 09:30

Stream	Total Demand (Veh/hr)	Junction Arrivals (Veh)	Capacity (Veh/hr)	RFC	Throughput (Veh/hr)	Start queue (Veh)	End queue (Veh)	Delay (s)	Unsignalised level of service
B-AC	77	19	554	0.139	77	0.1	0.2	7.541	A
C-AB	50	13	650	0.077	50	0.1	0.1	5.998	A
C-A	0	0			0				
A-B	49	12			49				
A-C	0	0			0				

09:30 - 09:45

Stream	Total Demand (Veh/hr)	Junction Arrivals (Veh)	Capacity (Veh/hr)	RFC	Throughput (Veh/hr)	Start queue (Veh)	End queue (Veh)	Delay (s)	Unsignalised level of service
B-AC	95	24	551	0.172	95	0.2	0.2	7.883	A
C-AB	62	15	648	0.095	62	0.1	0.1	6.140	A
C-A	0	0			0				
A-B	59	15			59				
A-C	0	0			0				

09:45 - 10:00

Stream	Total Demand (Veh/hr)	Junction Arrivals (Veh)	Capacity (Veh/hr)	RFC	Throughput (Veh/hr)	Start queue (Veh)	End queue (Veh)	Delay (s)	Unsignalised level of service
B-AC	95	24	551	0.172	95	0.2	0.2	7.890	A
C-AB	62	15	648	0.095	62	0.1	0.1	6.140	A
C-A	0	0			0				
A-B	59	15			59				
A-C	0	0			0				

10:00 - 10:15

Stream	Total Demand (Veh/hr)	Junction Arrivals (Veh)	Capacity (Veh/hr)	RFC	Throughput (Veh/hr)	Start queue (Veh)	End queue (Veh)	Delay (s)	Unsignalised level of service
B-AC	77	19	554	0.139	77	0.2	0.2	7.550	A
C-AB	50	13	650	0.077	50	0.1	0.1	6.002	A
C-A	0	0			0				
A-B	49	12			49				
A-C	0	0			0				

10:15 - 10:30

Stream	Total Demand (Veh/hr)	Junction Arrivals (Veh)	Capacity (Veh/hr)	RFC	Throughput (Veh/hr)	Start queue (Veh)	End queue (Veh)	Delay (s)	Unsignalised level of service
B-AC	65	16	557	0.116	65	0.2	0.1	7.320	A
C-AB	42	11	652	0.065	42	0.1	0.1	5.901	A
C-A	0	0			0				
A-B	41	10			41				
A-C	0	0			0				

Queue Variation Results for each time segment

09:00 - 09:15

Stream	Mean (Veh)	Q05 (Veh)	Q50 (Veh)	Q90 (Veh)	Q95 (Veh)	Percentile message	Marker message	Probability of reaching or exceeding marker	Probability of exactly reaching marker
B-AC	0.13	0.00	0.00	0.13	0.13			N/A	N/A
C-AB	0.07	0.00	0.00	0.07	0.07			N/A	N/A

09:15 - 09:30

Stream	Mean (Veh)	Q05 (Veh)	Q50 (Veh)	Q90 (Veh)	Q95 (Veh)	Percentile message	Marker message	Probability of reaching or exceeding marker	Probability of exactly reaching marker
B-AC	0.16	0.00	0.00	0.16	0.16			N/A	N/A
C-AB	0.08	0.03	0.26	0.46	0.49			N/A	N/A

09:30 - 09:45

Stream	Mean (Veh)	Q05 (Veh)	Q50 (Veh)	Q90 (Veh)	Q95 (Veh)	Percentile message	Marker message	Probability of reaching or exceeding marker	Probability of exactly reaching marker
B-AC	0.21	0.03	0.26	0.46	0.49			N/A	N/A
C-AB	0.10	0.03	0.26	0.47	0.49			N/A	N/A

09:45 - 10:00

Stream	Mean (Veh)	Q05 (Veh)	Q50 (Veh)	Q90 (Veh)	Q95 (Veh)	Percentile message	Marker message	Probability of reaching or exceeding marker	Probability of exactly reaching marker
B-AC	0.21	0.03	0.27	0.48	0.77			N/A	N/A
C-AB	0.10	0.03	0.25	0.45	0.48			N/A	N/A

10:00 - 10:15

Stream	Mean (Veh)	Q05 (Veh)	Q50 (Veh)	Q90 (Veh)	Q95 (Veh)	Percentile message	Marker message	Probability of reaching or exceeding marker	Probability of exactly reaching marker
B-AC	0.16	0.00	0.00	0.16	0.16			N/A	N/A
C-AB	0.08	0.00	0.00	0.08	0.08			N/A	N/A

10:15 - 10:30

Stream	Mean (Veh)	Q05 (Veh)	Q50 (Veh)	Q90 (Veh)	Q95 (Veh)	Percentile message	Marker message	Probability of reaching or exceeding marker	Probability of exactly reaching marker
B-AC	0.13	0.00	0.00	0.13	0.13			N/A	N/A
C-AB	0.07	0.00	0.00	0.07	0.07			N/A	N/A

2027 + Development Flows, AM

Data Errors and Warnings

Severity	Area	Item	Description
Warning	Demand Set Relationship	D4 - 2027 + Development Flows, AM	Demand Set relationships are chained. This may slow down the file.
Warning	Vehicle Mix		HV% is zero for all movements / time segments. Vehicle Mix matrix should be completed whether working in PCUs or Vehs. If HV% at the junction is genuinely zero, please ignore this warning.
Warning	Queue variations	Analysis Options	Queue percentiles may be unreliable if the mean queue in any time segment is very low or very high.

Junction Network

Junctions

Junction	Name	Junction type	Arm A Direction	Arm B Direction	Arm C Direction	Use circulating lanes	Junction Delay (s)	Junction LOS
1	Development Access	T-Junction	Two-way	Two-way	Two-way		1.27	A

Junction Network

Driving side	Lighting	Network residual capacity (%)	First arm reaching threshold	Network delay (s)	Network LOS
Left	Normal/unknown	58	Stream B-AC	1.27	A

Traffic Demand

Demand Set Details

ID	Scenario name	Time Period name	Traffic profile type	Start time (HH:mm)	Finish time (HH:mm)	Time segment length (min)	Run automatically	Relationship type	Relationship
D4	2027 + Development Flows	AM	ONE HOUR	09:00	10:30	15	✓	Simple	D2+D3

Demand overview (Traffic)

Arm	Linked arm	Profile type	Use O-D data	Average Demand (Veh/hr)	Scaling Factor (%)
A		ONE HOUR	✓	495	100.000
B		ONE HOUR	✓	86	100.000
C		ONE HOUR	✓	612	100.000

Origin-Destination Data

Demand (Veh/hr)

		To		
		A	B	C
From	A	0	54	441
	B	51	0	35
	C	556	56	0

Proportions

		To		
		A	B	C
From	A	0.00	0.11	0.89
	B	0.59	0.00	0.41
	C	0.91	0.09	0.00

Vehicle Mix

HV data entry mode	PCU Factor for a HV (PCU)
HV Percentages	2.00

Heavy Vehicle %

		To		
		A	B	C
From	A	0	0	0
	B	0	0	0
	C	0	0	0

Average PCU Per Veh

		To		
		A	B	C
From	A	1.000	1.000	1.000
	B	1.000	1.000	1.000
	C	1.000	1.000	1.000

Detailed Demand Data

Demand for each time segment

Arm	Time Segment	Demand (Veh/hr)	Demand in PCU (PCU/hr)
A	09:00-09:15	372	372
	09:15-09:30	445	445
	09:30-09:45	545	545
	09:45-10:00	545	545
	10:00-10:15	445	445

	10:15-10:30	372	372
B	09:00-09:15	65	65
	09:15-09:30	77	77
	09:30-09:45	95	95
	09:45-10:00	95	95
	10:00-10:15	77	77
	10:15-10:30	65	65
C	09:00-09:15	461	461
	09:15-09:30	550	550
	09:30-09:45	674	674
	09:45-10:00	674	674
	10:00-10:15	550	550
	10:15-10:30	461	461

Results

Results Summary for whole modelled period

Stream	Max RFC	Max Delay (s)	Max Queue (Veh)	Max 95th percentile Queue (Veh)	Max LOS	Average Demand (Veh/hr)	Total Junction Arrivals (Veh)
B-AC	0.25	12.75	0.3	1.5	B	79	118
C-AB	0.11	7.57	0.1	0.5	A	51	77
C-A						510	765
A-B						50	74
A-C						404	606

Main Results for each time segment

09:00 - 09:15

Stream	Total Demand (Veh/hr)	Junction Arrivals (Veh)	Capacity (Veh/hr)	RFC	Throughput (Veh/hr)	Start queue (Veh)	End queue (Veh)	Delay (s)	Unsignalised level of service
B-AC	65	16	440	0.147	64	0.0	0.2	9.548	A
C-AB	42	11	576	0.073	42	0.0	0.1	6.731	A
C-A	419	105			419				
A-B	41	10			41				
A-C	332	83			332				

09:15 - 09:30

Stream	Total Demand (Veh/hr)	Junction Arrivals (Veh)	Capacity (Veh/hr)	RFC	Throughput (Veh/hr)	Start queue (Veh)	End queue (Veh)	Delay (s)	Unsignalised level of service
B-AC	77	19	414	0.187	77	0.2	0.2	10.674	B
C-AB	50	13	560	0.090	50	0.1	0.1	7.063	A
C-A	500	125			500				
A-B	49	12			49				
A-C	396	99			396				

09:30 - 09:45

Stream	Total Demand (Veh/hr)	Junction Arrivals (Veh)	Capacity (Veh/hr)	RFC	Throughput (Veh/hr)	Start queue (Veh)	End queue (Veh)	Delay (s)	Unsignalised level of service
B-AC	95	24	377	0.251	94	0.2	0.3	12.710	B
C-AB	62	15	537	0.115	62	0.1	0.1	7.566	A
C-A	612	153			612				
A-B	59	15			59				
A-C	485	121			485				

09:45 - 10:00

Stream	Total Demand (Veh/hr)	Junction Arrivals (Veh)	Capacity (Veh/hr)	RFC	Throughput (Veh/hr)	Start queue (Veh)	End queue (Veh)	Delay (s)	Unsignalised level of service
B-AC	95	24	377	0.251	95	0.3	0.3	12.749	B
C-AB	62	15	537	0.115	62	0.1	0.1	7.569	A
C-A	612	153			612				
A-B	59	15			59				
A-C	485	121			485				

10:00 - 10:15

Stream	Total Demand (Veh/hr)	Junction Arrivals (Veh)	Capacity (Veh/hr)	RFC	Throughput (Veh/hr)	Start queue (Veh)	End queue (Veh)	Delay (s)	Unsignalised level of service
B-AC	77	19	414	0.187	78	0.3	0.2	10.714	B
C-AB	50	13	560	0.090	50	0.1	0.1	7.066	A
C-A	500	125			500				
A-B	49	12			49				
A-C	396	99			396				

10:15 - 10:30

Stream	Total Demand (Veh/hr)	Junction Arrivals (Veh)	Capacity (Veh/hr)	RFC	Throughput (Veh/hr)	Start queue (Veh)	End queue (Veh)	Delay (s)	Unsignalised level of service
B-AC	65	16	440	0.147	65	0.2	0.2	9.596	A
C-AB	42	11	576	0.073	42	0.1	0.1	6.741	A
C-A	419	105			419				
A-B	41	10			41				
A-C	332	83			332				

Queue Variation Results for each time segment

09:00 - 09:15

Stream	Mean (Veh)	Q05 (Veh)	Q50 (Veh)	Q90 (Veh)	Q95 (Veh)	Percentile message	Marker message	Probability of reaching or exceeding marker	Probability of exactly reaching marker
B-AC	0.17	0.00	0.00	0.17	0.17			N/A	N/A
C-AB	0.08	0.00	0.00	0.08	0.08			N/A	N/A

09:15 - 09:30

Stream	Mean (Veh)	Q05 (Veh)	Q50 (Veh)	Q90 (Veh)	Q95 (Veh)	Percentile message	Marker message	Probability of reaching or exceeding marker	Probability of exactly reaching marker
B-AC	0.23	0.00	0.00	0.23	0.23			N/A	N/A
C-AB	0.10	0.03	0.25	0.45	0.48			N/A	N/A

09:30 - 09:45

Stream	Mean (Veh)	Q05 (Veh)	Q50 (Veh)	Q90 (Veh)	Q95 (Veh)	Percentile message	Marker message	Probability of reaching or exceeding marker	Probability of exactly reaching marker
B-AC	0.33	0.03	0.26	0.46	0.49			N/A	N/A
C-AB	0.13	0.03	0.26	0.47	0.49			N/A	N/A

09:45 - 10:00

Stream	Mean (Veh)	Q05 (Veh)	Q50 (Veh)	Q90 (Veh)	Q95 (Veh)	Percentile message	Marker message	Probability of reaching or exceeding marker	Probability of exactly reaching marker
B-AC	0.33	0.03	0.31	1.16	1.48			N/A	N/A
C-AB	0.13	0.03	0.25	0.45	0.48			N/A	N/A

10:00 - 10:15

Stream	Mean (Veh)	Q05 (Veh)	Q50 (Veh)	Q90 (Veh)	Q95 (Veh)	Percentile message	Marker message	Probability of reaching or exceeding marker	Probability of exactly reaching marker
B-AC	0.23	0.00	0.00	0.23	0.23			N/A	N/A
C-AB	0.10	0.00	0.00	0.10	0.10			N/A	N/A

10:15 - 10:30

Stream	Mean (Veh)	Q05 (Veh)	Q50 (Veh)	Q90 (Veh)	Q95 (Veh)	Percentile message	Marker message	Probability of reaching or exceeding marker	Probability of exactly reaching marker
B-AC	0.17	0.00	0.00	0.17	0.17			N/A	N/A
C-AB	0.08	0.00	0.00	0.08	0.08			N/A	N/A

2032 Faactored Base + 5yrs, AM

Data Errors and Warnings

Severity	Area	Item	Description
Warning	Demand Set Relationship	D4 - 2027 + Development Flows, AM	Demand Set relationships are chained. This may slow down the file.
Warning	Vehicle Mix		HV% is zero for all movements / time segments. Vehicle Mix matrix should be completed whether working in PCUs or Vehs. If HV% at the junction is genuinely zero, please ignore this warning.
Warning	Queue variations	Analysis Options	Queue percentiles may be unreliable if the mean queue in any time segment is very low or very high.

Junction Network

Junctions

Junction	Name	Junction type	Arm A Direction	Arm B Direction	Arm C Direction	Use circulating lanes	Junction Delay (s)	Junction LOS
1	Development Access	T-Junction	Two-way	Two-way	Two-way		0.00	A

Junction Network

Driving side	Lighting	Network residual capacity (%)	First arm reaching threshold	Network delay (s)	Network LOS
Left	Normal/unknown	900		0.00	A

Traffic Demand

Demand Set Details

ID	Scenario name	Time Period name	Traffic profile type	Start time (HH:mm)	Finish time (HH:mm)	Time segment length (min)	Run automatically	Relationship type	Relationship
D5	2032 Faactored Base + 5yrs	AM	ONE HOUR	09:00	10:30	15	✓	Simple	D1*G2

Demand overview (Traffic)

Arm	Linked arm	Profile type	Use O-D data	Average Demand (Veh/hr)	Scaling Factor (%)
A		ONE HOUR	✓	455	100.000
B		ONE HOUR	✓	0	100.000
C		ONE HOUR	✓	574	100.000

Origin-Destination Data

Demand (Veh/hr)

	To			
	A	B	C	
From	A	0	0	455
	B	0	0	0
	C	574	0	0

Proportions

	To			
	A	B	C	
From	A	0.00	0.00	1.00
	B	0.33	0.33	0.33
	C	1.00	0.00	0.00

Vehicle Mix

HV data entry mode	PCU Factor for a HV (PCU)
HV Percentages	2.00

Heavy Vehicle %

	To			
	A	B	C	
From	A	0	0	0
	B	0	0	0
	C	0	0	0

Average PCU Per Veh

	To			
	A	B	C	
From	A	1.000	1.000	1.000
	B	1.000	1.000	1.000
	C	1.000	1.000	1.000

Detailed Demand Data

Demand for each time segment

Arm	Time Segment	Demand (Veh/hr)	Demand in PCU (PCU/hr)
A	09:00-09:15	342	342
	09:15-09:30	409	409
	09:30-09:45	501	501
	09:45-10:00	501	501
	10:00-10:15	409	409

	10:15-10:30	342	342
B	09:00-09:15	0	0
	09:15-09:30	0	0
	09:30-09:45	0	0
	09:45-10:00	0	0
	10:00-10:15	0	0
	10:15-10:30	0	0
C	09:00-09:15	432	432
	09:15-09:30	516	516
	09:30-09:45	632	632
	09:45-10:00	632	632
	10:00-10:15	516	516
	10:15-10:30	432	432

Results

Results Summary for whole modelled period

Stream	Max RFC	Max Delay (s)	Max Queue (Veh)	Max 95th percentile Queue (Veh)	Max LOS	Average Demand (Veh/hr)	Total Junction Arrivals (Veh)
B-AC	0.00	0.00	0.0	~1	A	0	0
C-AB	0.00	0.00	0.0	~1	A	0	0
C-A						527	790
A-B						0	0
A-C						417	626

Main Results for each time segment

09:00 - 09:15

Stream	Total Demand (Veh/hr)	Junction Arrivals (Veh)	Capacity (Veh/hr)	RFC	Throughput (Veh/hr)	Start queue (Veh)	End queue (Veh)	Delay (s)	Unsignalised level of service
B-AC	0	0	466	0.000	0	0.0	0.0	0.000	A
C-AB	0	0	1167	0.000	0	0.0	0.0	0.000	A
C-A	432	108			432				
A-B	0	0			0				
A-C	342	86			342				

09:15 - 09:30

Stream	Total Demand (Veh/hr)	Junction Arrivals (Veh)	Capacity (Veh/hr)	RFC	Throughput (Veh/hr)	Start queue (Veh)	End queue (Veh)	Delay (s)	Unsignalised level of service
B-AC	0	0	443	0.000	0	0.0	0.0	0.000	A
C-AB	0	0	1136	0.000	0	0.0	0.0	0.000	A
C-A	516	129			516				
A-B	0	0			0				
A-C	409	102			409				

09:30 - 09:45

Stream	Total Demand (Veh/hr)	Junction Arrivals (Veh)	Capacity (Veh/hr)	RFC	Throughput (Veh/hr)	Start queue (Veh)	End queue (Veh)	Delay (s)	Unsignalised level of service
B-AC	0	0	410	0.000	0	0.0	0.0	0.000	A
C-AB	0	0	1094	0.000	0	0.0	0.0	0.000	A
C-A	632	158			632				
A-B	0	0			0				
A-C	501	125			501				

09:45 - 10:00

Stream	Total Demand (Veh/hr)	Junction Arrivals (Veh)	Capacity (Veh/hr)	RFC	Throughput (Veh/hr)	Start queue (Veh)	End queue (Veh)	Delay (s)	Unsignalised level of service
B-AC	0	0	410	0.000	0	0.0	0.0	0.000	A
C-AB	0	0	1094	0.000	0	0.0	0.0	0.000	A
C-A	632	158			632				
A-B	0	0			0				
A-C	501	125			501				

10:00 - 10:15

Stream	Total Demand (Veh/hr)	Junction Arrivals (Veh)	Capacity (Veh/hr)	RFC	Throughput (Veh/hr)	Start queue (Veh)	End queue (Veh)	Delay (s)	Unsignalised level of service
B-AC	0	0	443	0.000	0	0.0	0.0	0.000	A
C-AB	0	0	1136	0.000	0	0.0	0.0	0.000	A
C-A	516	129			516				
A-B	0	0			0				
A-C	409	102			409				

10:15 - 10:30

Stream	Total Demand (Veh/hr)	Junction Arrivals (Veh)	Capacity (Veh/hr)	RFC	Throughput (Veh/hr)	Start queue (Veh)	End queue (Veh)	Delay (s)	Unsignalised level of service
B-AC	0	0	466	0.000	0	0.0	0.0	0.000	A
C-AB	0	0	1167	0.000	0	0.0	0.0	0.000	A
C-A	432	108			432				
A-B	0	0			0				
A-C	342	86			342				

Queue Variation Results for each time segment

09:00 - 09:15

Stream	Mean (Veh)	Q05 (Veh)	Q50 (Veh)	Q90 (Veh)	Q95 (Veh)	Percentile message	Marker message	Probability of reaching or exceeding marker	Probability of exactly reaching marker
B-AC	0.00	0.00	0.00	0.00	0.00			N/A	N/A
C-AB	0.00	0.00	0.00	0.00	0.00			N/A	N/A

09:15 - 09:30

Stream	Mean (Veh)	Q05 (Veh)	Q50 (Veh)	Q90 (Veh)	Q95 (Veh)	Percentile message	Marker message	Probability of reaching or exceeding marker	Probability of exactly reaching marker
B-AC	0.00	0.00	0.00	0.00	0.00			N/A	N/A
C-AB	0.00	0.00	0.00	0.00	0.00			N/A	N/A

09:30 - 09:45

Stream	Mean (Veh)	Q05 (Veh)	Q50 (Veh)	Q90 (Veh)	Q95 (Veh)	Percentile message	Marker message	Probability of reaching or exceeding marker	Probability of exactly reaching marker
B-AC	0.00	0.00	0.00	0.00	0.00			N/A	N/A
C-AB	0.00	0.00	0.00	0.00	0.00			N/A	N/A

09:45 - 10:00

Stream	Mean (Veh)	Q05 (Veh)	Q50 (Veh)	Q90 (Veh)	Q95 (Veh)	Percentile message	Marker message	Probability of reaching or exceeding marker	Probability of exactly reaching marker
B-AC	0.00	0.00	0.00	0.00	0.00			N/A	N/A
C-AB	0.00	0.00	0.00	0.00	0.00			N/A	N/A

10:00 - 10:15

Stream	Mean (Veh)	Q05 (Veh)	Q50 (Veh)	Q90 (Veh)	Q95 (Veh)	Percentile message	Marker message	Probability of reaching or exceeding marker	Probability of exactly reaching marker
B-AC	0.00	0.00	0.00	0.00	0.00			N/A	N/A
C-AB	0.00	0.00	0.00	0.00	0.00			N/A	N/A

10:15 - 10:30

Stream	Mean (Veh)	Q05 (Veh)	Q50 (Veh)	Q90 (Veh)	Q95 (Veh)	Percentile message	Marker message	Probability of reaching or exceeding marker	Probability of exactly reaching marker
B-AC	0.00	0.00	0.00	0.00	0.00			N/A	N/A
C-AB	0.00	0.00	0.00	0.00	0.00			N/A	N/A

2032 Faactored Base + Dev Flows = +5yrs, AM

Data Errors and Warnings

Severity	Area	Item	Description
Warning	Demand Set Relationship	D4 - 2027 + Development Flows, AM	Demand Set relationships are chained. This may slow down the file.
Warning	Vehicle Mix		HV% is zero for all movements / time segments. Vehicle Mix matrix should be completed whether working in PCUs or Vehs. If HV% at the junction is genuinely zero, please ignore this warning.
Warning	Queue variations	Analysis Options	Queue percentiles may be unreliable if the mean queue in any time segment is very low or very high.

Junction Network

Junctions

Junction	Name	Junction type	Arm A Direction	Arm B Direction	Arm C Direction	Use circulating lanes	Junction Delay (s)	Junction LOS
1	Development Access	T-Junction	Two-way	Two-way	Two-way		1.26	A

Junction Network

Driving side	Lighting	Network residual capacity (%)	First arm reaching threshold	Network delay (s)	Network LOS
Left	Normal/unknown	55	Stream B-AC	1.26	A

Traffic Demand

Demand Set Details

ID	Scenario name	Time Period name	Traffic profile type	Start time (HH:mm)	Finish time (HH:mm)	Time segment length (min)	Run automatically	Relationship type	Relationship
D6	2032 Faactored Base + Dev Flows = +5yrs	AM	ONE HOUR	09:00	10:30	15	✓	Simple	D3+D5

Demand overview (Traffic)

Arm	Linked arm	Profile type	Use O-D data	Average Demand (Veh/hr)	Scaling Factor (%)
A		ONE HOUR	✓	509	100.000
B		ONE HOUR	✓	86	100.000
C		ONE HOUR	✓	630	100.000

Origin-Destination Data

Demand (Veh/hr)

		To		
		A	B	C
From	A	0	54	455
	B	51	0	35
	C	574	56	0

Proportions

		To		
		A	B	C
From	A	0.00	0.11	0.89
	B	0.59	0.00	0.41
	C	0.91	0.09	0.00

Vehicle Mix

HV data entry mode	PCU Factor for a HV (PCU)
HV Percentages	2.00

Heavy Vehicle %

		To		
		A	B	C
From	A	0	0	0
	B	0	0	0
	C	0	0	0

Average PCU Per Veh

		To		
		A	B	C
From	A	1.000	1.000	1.000
	B	1.000	1.000	1.000
	C	1.000	1.000	1.000

Detailed Demand Data

Demand for each time segment

Arm	Time Segment	Demand (Veh/hr)	Demand in PCU (PCU/hr)
A	09:00-09:15	383	383
	09:15-09:30	457	457
	09:30-09:45	560	560

	09:45-10:00	560	560
	10:00-10:15	457	457
	10:15-10:30	383	383
B	09:00-09:15	65	65
	09:15-09:30	77	77
	09:30-09:45	95	95
	09:45-10:00	95	95
	10:00-10:15	77	77
	10:15-10:30	65	65
C	09:00-09:15	474	474
	09:15-09:30	566	566
	09:30-09:45	694	694
	09:45-10:00	694	694
	10:00-10:15	566	566
	10:15-10:30	474	474

Results

Results Summary for whole modelled period

Stream	Max RFC	Max Delay (s)	Max Queue (Veh)	Max 95th percentile Queue (Veh)	Max LOS	Average Demand (Veh/hr)	Total Junction Arrivals (Veh)
B-AC	0.26	13.02	0.3	1.0	B	79	118
C-AB	0.12	7.63	0.1	0.5	A	51	77
C-A						527	790
A-B						50	74
A-C						417	626

Main Results for each time segment

09:00 - 09:15

Stream	Total Demand (Veh/hr)	Junction Arrivals (Veh)	Capacity (Veh/hr)	RFC	Throughput (Veh/hr)	Start queue (Veh)	End queue (Veh)	Delay (s)	Unsignalised level of service
B-AC	65	16	437	0.148	64	0.0	0.2	9.648	A
C-AB	42	11	574	0.073	42	0.0	0.1	6.760	A
C-A	432	108			432				
A-B	41	10			41				
A-C	342	86			342				

09:15 - 09:30

Stream	Total Demand (Veh/hr)	Junction Arrivals (Veh)	Capacity (Veh/hr)	RFC	Throughput (Veh/hr)	Start queue (Veh)	End queue (Veh)	Delay (s)	Unsignalised level of service
B-AC	77	19	409	0.189	77	0.2	0.2	10.824	B
C-AB	50	13	557	0.090	50	0.1	0.1	7.104	A
C-A	516	129			516				
A-B	49	12			49				
A-C	409	102			409				

09:30 - 09:45

Stream	Total Demand (Veh/hr)	Junction Arrivals (Veh)	Capacity (Veh/hr)	RFC	Throughput (Veh/hr)	Start queue (Veh)	End queue (Veh)	Delay (s)	Unsignalised level of service
B-AC	95	24	371	0.255	94	0.2	0.3	12.962	B
C-AB	62	15	534	0.116	62	0.1	0.1	7.624	A
C-A	632	158			632				
A-B	59	15			59				
A-C	501	125			501				

09:45 - 10:00

Stream	Total Demand (Veh/hr)	Junction Arrivals (Veh)	Capacity (Veh/hr)	RFC	Throughput (Veh/hr)	Start queue (Veh)	End queue (Veh)	Delay (s)	Unsignalised level of service
B-AC	95	24	371	0.255	95	0.3	0.3	13.023	B
C-AB	62	15	534	0.116	62	0.1	0.1	7.627	A
C-A	632	158			632				
A-B	59	15			59				
A-C	501	125			501				

10:00 - 10:15

Stream	Total Demand (Veh/hr)	Junction Arrivals (Veh)	Capacity (Veh/hr)	RFC	Throughput (Veh/hr)	Start queue (Veh)	End queue (Veh)	Delay (s)	Unsignalised level of service
B-AC	77	19	409	0.189	78	0.3	0.2	10.870	B
C-AB	50	13	557	0.090	50	0.1	0.1	7.110	A
C-A	516	129			516				

A-B	49	12			49				
A-C	409	102			409				

10:15 - 10:30

Stream	Total Demand (Veh/hr)	Junction Arrivals (Veh)	Capacity (Veh/hr)	RFC	Throughput (Veh/hr)	Start queue (Veh)	End queue (Veh)	Delay (s)	Unsignalised level of service
B-AC	65	16	436	0.148	65	0.2	0.2	9.699	A
C-AB	42	11	574	0.073	42	0.1	0.1	6.770	A
C-A	432	108			432				
A-B	41	10			41				
A-C	342	86			342				

Queue Variation Results for each time segment**09:00 - 09:15**

Stream	Mean (Veh)	Q05 (Veh)	Q50 (Veh)	Q90 (Veh)	Q95 (Veh)	Percentile message	Marker message	Probability of reaching or exceeding marker	Probability of exactly reaching marker
B-AC	0.17	0.00	0.00	0.17	0.17			N/A	N/A
C-AB	0.08	0.00	0.00	0.08	0.08			N/A	N/A

09:15 - 09:30

Stream	Mean (Veh)	Q05 (Veh)	Q50 (Veh)	Q90 (Veh)	Q95 (Veh)	Percentile message	Marker message	Probability of reaching or exceeding marker	Probability of exactly reaching marker
B-AC	0.23	0.00	0.00	0.23	0.23			N/A	N/A
C-AB	0.10	0.03	0.25	0.45	0.48			N/A	N/A

09:30 - 09:45

Stream	Mean (Veh)	Q05 (Veh)	Q50 (Veh)	Q90 (Veh)	Q95 (Veh)	Percentile message	Marker message	Probability of reaching or exceeding marker	Probability of exactly reaching marker
B-AC	0.34	0.03	0.26	0.46	0.49			N/A	N/A
C-AB	0.13	0.03	0.26	0.47	0.49			N/A	N/A

09:45 - 10:00

Stream	Mean (Veh)	Q05 (Veh)	Q50 (Veh)	Q90 (Veh)	Q95 (Veh)	Percentile message	Marker message	Probability of reaching or exceeding marker	Probability of exactly reaching marker
B-AC	0.34	0.03	0.31	1.02	1.02			N/A	N/A
C-AB	0.13	0.03	0.25	0.45	0.48			N/A	N/A

10:00 - 10:15

Stream	Mean (Veh)	Q05 (Veh)	Q50 (Veh)	Q90 (Veh)	Q95 (Veh)	Percentile message	Marker message	Probability of reaching or exceeding marker	Probability of exactly reaching marker
B-AC	0.24	0.00	0.00	0.24	0.24			N/A	N/A
C-AB	0.10	0.00	0.00	0.10	0.10			N/A	N/A

10:15 - 10:30

Stream	Mean (Veh)	Q05 (Veh)	Q50 (Veh)	Q90 (Veh)	Q95 (Veh)	Percentile message	Marker message	Probability of reaching or exceeding marker	Probability of exactly reaching marker
B-AC	0.18	0.00	0.00	0.18	0.18			N/A	N/A
C-AB	0.08	0.00	0.00	0.08	0.08			N/A	N/A

2042 Faactored Base + 15yrs, AM

Data Errors and Warnings

Severity	Area	Item	Description
Warning	Demand Set Relationship	D4 - 2027 + Development Flows, AM	Demand Set relationships are chained. This may slow down the file.
Warning	Vehicle Mix		HV% is zero for all movements / time segments. Vehicle Mix matrix should be completed whether working in PCUs or Vehs. If HV% at the junction is genuinely zero, please ignore this warning.
Warning	Queue variations	Analysis Options	Queue percentiles may be unreliable if the mean queue in any time segment is very low or very high.

Junction Network

Junctions

Junction	Name	Junction type	Arm A Direction	Arm B Direction	Arm C Direction	Use circulating lanes	Junction Delay (s)	Junction LOS
1	Development Access	T-Junction	Two-way	Two-way	Two-way		0.00	A

Junction Network

Driving side	Lighting	Network residual capacity (%)	First arm reaching threshold	Network delay (s)	Network LOS
Left	Normal/unknown	900		0.00	A

Traffic Demand

Demand Set Details

ID	Scenario name	Time Period name	Traffic profile type	Start time (HH:mm)	Finish time (HH:mm)	Time segment length (min)	Run automatically	Relationship type	Relationship
D7	2042 Faactored Base + 15yrs	AM	ONE HOUR	09:00	10:30	15	✓	Simple	D1*G3

Demand overview (Traffic)

Arm	Linked arm	Profile type	Use O-D data	Average Demand (Veh/hr)	Scaling Factor (%)
A		ONE HOUR	✓	464	100.000
B		ONE HOUR	✓	0	100.000
C		ONE HOUR	✓	585	100.000

Origin-Destination Data

Demand (Veh/hr)

	To			
	A	B	C	
From	A	0	0	464
	B	0	0	0
	C	585	0	0

Proportions

	To			
	A	B	C	
From	A	0.00	0.00	1.00
	B	0.33	0.33	0.33
	C	1.00	0.00	0.00

Vehicle Mix

HV data entry mode	PCU Factor for a HV (PCU)
HV Percentages	2.00

Heavy Vehicle %

	To			
	A	B	C	
From	A	0	0	0
	B	0	0	0
	C	0	0	0

Average PCU Per Veh

	To			
	A	B	C	
From	A	1.000	1.000	1.000
	B	1.000	1.000	1.000
	C	1.000	1.000	1.000

Detailed Demand Data

Demand for each time segment

Arm	Time Segment	Demand (Veh/hr)	Demand in PCU (PCU/hr)
A	09:00-09:15	349	349
	09:15-09:30	417	417
	09:30-09:45	511	511
	09:45-10:00	511	511
	10:00-10:15	417	417

	10:15-10:30	349	349
B	09:00-09:15	0	0
	09:15-09:30	0	0
	09:30-09:45	0	0
	09:45-10:00	0	0
	10:00-10:15	0	0
	10:15-10:30	0	0
C	09:00-09:15	441	441
	09:15-09:30	526	526
	09:30-09:45	644	644
	09:45-10:00	644	644
	10:00-10:15	526	526
	10:15-10:30	441	441

Results

Results Summary for whole modelled period

Stream	Max RFC	Max Delay (s)	Max Queue (Veh)	Max 95th percentile Queue (Veh)	Max LOS	Average Demand (Veh/hr)	Total Junction Arrivals (Veh)
B-AC	0.00	0.00	0.0	~1	A	0	0
C-AB	0.00	0.00	0.0	~1	A	0	0
C-A						537	806
A-B						0	0
A-C						426	638

Main Results for each time segment

09:00 - 09:15

Stream	Total Demand (Veh/hr)	Junction Arrivals (Veh)	Capacity (Veh/hr)	RFC	Throughput (Veh/hr)	Start queue (Veh)	End queue (Veh)	Delay (s)	Unsignalised level of service
B-AC	0	0	464	0.000	0	0.0	0.0	0.000	A
C-AB	0	0	1163	0.000	0	0.0	0.0	0.000	A
C-A	441	110			441				
A-B	0	0			0				
A-C	349	87			349				

09:15 - 09:30

Stream	Total Demand (Veh/hr)	Junction Arrivals (Veh)	Capacity (Veh/hr)	RFC	Throughput (Veh/hr)	Start queue (Veh)	End queue (Veh)	Delay (s)	Unsignalised level of service
B-AC	0	0	440	0.000	0	0.0	0.0	0.000	A
C-AB	0	0	1132	0.000	0	0.0	0.0	0.000	A
C-A	526	132			526				
A-B	0	0			0				
A-C	417	104			417				

09:30 - 09:45

Stream	Total Demand (Veh/hr)	Junction Arrivals (Veh)	Capacity (Veh/hr)	RFC	Throughput (Veh/hr)	Start queue (Veh)	End queue (Veh)	Delay (s)	Unsignalised level of service
B-AC	0	0	407	0.000	0	0.0	0.0	0.000	A
C-AB	0	0	1090	0.000	0	0.0	0.0	0.000	A
C-A	644	161			644				
A-B	0	0			0				
A-C	511	128			511				

09:45 - 10:00

Stream	Total Demand (Veh/hr)	Junction Arrivals (Veh)	Capacity (Veh/hr)	RFC	Throughput (Veh/hr)	Start queue (Veh)	End queue (Veh)	Delay (s)	Unsignalised level of service
B-AC	0	0	407	0.000	0	0.0	0.0	0.000	A
C-AB	0	0	1090	0.000	0	0.0	0.0	0.000	A
C-A	644	161			644				
A-B	0	0			0				
A-C	511	128			511				

10:00 - 10:15

Stream	Total Demand (Veh/hr)	Junction Arrivals (Veh)	Capacity (Veh/hr)	RFC	Throughput (Veh/hr)	Start queue (Veh)	End queue (Veh)	Delay (s)	Unsignalised level of service
B-AC	0	0	440	0.000	0	0.0	0.0	0.000	A
C-AB	0	0	1132	0.000	0	0.0	0.0	0.000	A
C-A	526	132			526				
A-B	0	0			0				
A-C	417	104			417				

10:15 - 10:30

Stream	Total Demand (Veh/hr)	Junction Arrivals (Veh)	Capacity (Veh/hr)	RFC	Throughput (Veh/hr)	Start queue (Veh)	End queue (Veh)	Delay (s)	Unsignalised level of service
B-AC	0	0	464	0.000	0	0.0	0.0	0.000	A
C-AB	0	0	1163	0.000	0	0.0	0.0	0.000	A
C-A	441	110			441				
A-B	0	0			0				
A-C	349	87			349				

Queue Variation Results for each time segment

09:00 - 09:15

Stream	Mean (Veh)	Q05 (Veh)	Q50 (Veh)	Q90 (Veh)	Q95 (Veh)	Percentile message	Marker message	Probability of reaching or exceeding marker	Probability of exactly reaching marker
B-AC	0.00	0.00	0.00	0.00	0.00			N/A	N/A
C-AB	0.00	0.00	0.00	0.00	0.00			N/A	N/A

09:15 - 09:30

Stream	Mean (Veh)	Q05 (Veh)	Q50 (Veh)	Q90 (Veh)	Q95 (Veh)	Percentile message	Marker message	Probability of reaching or exceeding marker	Probability of exactly reaching marker
B-AC	0.00	0.00	0.00	0.00	0.00			N/A	N/A
C-AB	0.00	0.00	0.00	0.00	0.00			N/A	N/A

09:30 - 09:45

Stream	Mean (Veh)	Q05 (Veh)	Q50 (Veh)	Q90 (Veh)	Q95 (Veh)	Percentile message	Marker message	Probability of reaching or exceeding marker	Probability of exactly reaching marker
B-AC	0.00	0.00	0.00	0.00	0.00			N/A	N/A
C-AB	0.00	0.00	0.00	0.00	0.00			N/A	N/A

09:45 - 10:00

Stream	Mean (Veh)	Q05 (Veh)	Q50 (Veh)	Q90 (Veh)	Q95 (Veh)	Percentile message	Marker message	Probability of reaching or exceeding marker	Probability of exactly reaching marker
B-AC	0.00	0.00	0.00	0.00	0.00			N/A	N/A
C-AB	0.00	0.00	0.00	0.00	0.00			N/A	N/A

10:00 - 10:15

Stream	Mean (Veh)	Q05 (Veh)	Q50 (Veh)	Q90 (Veh)	Q95 (Veh)	Percentile message	Marker message	Probability of reaching or exceeding marker	Probability of exactly reaching marker
B-AC	0.00	0.00	0.00	0.00	0.00			N/A	N/A
C-AB	0.00	0.00	0.00	0.00	0.00			N/A	N/A

10:15 - 10:30

Stream	Mean (Veh)	Q05 (Veh)	Q50 (Veh)	Q90 (Veh)	Q95 (Veh)	Percentile message	Marker message	Probability of reaching or exceeding marker	Probability of exactly reaching marker
B-AC	0.00	0.00	0.00	0.00	0.00			N/A	N/A
C-AB	0.00	0.00	0.00	0.00	0.00			N/A	N/A

2042 Faactored Base + 15yrs + Dev Flows, AM

Data Errors and Warnings

Severity	Area	Item	Description
Warning	Demand Set Relationship	D4 - 2027 + Development Flows, AM	Demand Set relationships are chained. This may slow down the file.
Warning	Vehicle Mix		HV% is zero for all movements / time segments. Vehicle Mix matrix should be completed whether working in PCUs or Vehs. If HV% at the junction is genuinely zero, please ignore this warning.
Warning	Queue variations	Analysis Options	Queue percentiles may be unreliable if the mean queue in any time segment is very low or very high.

Junction Network

Junctions

Junction	Name	Junction type	Arm A Direction	Arm B Direction	Arm C Direction	Use circulating lanes	Junction Delay (s)	Junction LOS
1	Development Access	T-Junction	Two-way	Two-way	Two-way		1.26	A

Junction Network

Driving side	Lighting	Network residual capacity (%)	First arm reaching threshold	Network delay (s)	Network LOS
Left	Normal/unknown	53	Stream B-AC	1.26	A

Traffic Demand

Demand Set Details

ID	Scenario name	Time Period name	Traffic profile type	Start time (HH:mm)	Finish time (HH:mm)	Time segment length (min)	Run automatically	Relationship type	Relationship
D8	2042 Faactored Base + 15yrs + Dev Flows	AM	ONE HOUR	09:00	10:30	15	✓	Simple	D3+D7

Demand overview (Traffic)

Arm	Linked arm	Profile type	Use O-D data	Average Demand (Veh/hr)	Scaling Factor (%)
A		ONE HOUR	✓	518	100.000
B		ONE HOUR	✓	86	100.000
C		ONE HOUR	✓	641	100.000

Origin-Destination Data

Demand (Veh/hr)

		To		
		A	B	C
From	A	0	54	464
	B	51	0	35
	C	585	56	0

Proportions

		To		
		A	B	C
From	A	0.00	0.10	0.90
	B	0.59	0.00	0.41
	C	0.91	0.09	0.00

Vehicle Mix

HV data entry mode	PCU Factor for a HV (PCU)
HV Percentages	2.00

Heavy Vehicle %

		To		
		A	B	C
From	A	0	0	0
	B	0	0	0
	C	0	0	0

Average PCU Per Veh

		To		
		A	B	C
From	A	1.000	1.000	1.000
	B	1.000	1.000	1.000
	C	1.000	1.000	1.000

Detailed Demand Data

Demand for each time segment

Arm	Time Segment	Demand (Veh/hr)	Demand in PCU (PCU/hr)
A	09:00-09:15	390	390
	09:15-09:30	466	466
	09:30-09:45	570	570

	09:45-10:00	570	570
	10:00-10:15	466	466
	10:15-10:30	390	390
B	09:00-09:15	65	65
	09:15-09:30	77	77
	09:30-09:45	95	95
	09:45-10:00	95	95
	10:00-10:15	77	77
	10:15-10:30	65	65
C	09:00-09:15	483	483
	09:15-09:30	577	577
	09:30-09:45	706	706
	09:45-10:00	706	706
	10:00-10:15	577	577
	10:15-10:30	483	483

Results

Results Summary for whole modelled period

Stream	Max RFC	Max Delay (s)	Max Queue (Veh)	Max 95th percentile Queue (Veh)	Max LOS	Average Demand (Veh/hr)	Total Junction Arrivals (Veh)
B-AC	0.26	13.20	0.3	1.1	B	79	118
C-AB	0.12	7.66	0.1	0.5	A	51	77
C-A						537	806
A-B						50	74
A-C						426	638

Main Results for each time segment

09:00 - 09:15

Stream	Total Demand (Veh/hr)	Junction Arrivals (Veh)	Capacity (Veh/hr)	RFC	Throughput (Veh/hr)	Start queue (Veh)	End queue (Veh)	Delay (s)	Unsignalised level of service
B-AC	65	16	434	0.149	64	0.0	0.2	9.712	A
C-AB	42	11	572	0.074	42	0.0	0.1	6.780	A
C-A	441	110			441				
A-B	41	10			41				
A-C	349	87			349				

09:15 - 09:30

Stream	Total Demand (Veh/hr)	Junction Arrivals (Veh)	Capacity (Veh/hr)	RFC	Throughput (Veh/hr)	Start queue (Veh)	End queue (Veh)	Delay (s)	Unsignalised level of service
B-AC	77	19	406	0.190	77	0.2	0.2	10.922	B
C-AB	50	13	555	0.091	50	0.1	0.1	7.130	A
C-A	526	132			526				
A-B	49	12			49				
A-C	417	104			417				

09:30 - 09:45

Stream	Total Demand (Veh/hr)	Junction Arrivals (Veh)	Capacity (Veh/hr)	RFC	Throughput (Veh/hr)	Start queue (Veh)	End queue (Veh)	Delay (s)	Unsignalised level of service
B-AC	95	24	367	0.258	94	0.2	0.3	13.160	B
C-AB	62	15	531	0.116	62	0.1	0.1	7.660	A
C-A	644	161			644				
A-B	59	15			59				
A-C	511	128			511				

09:45 - 10:00

Stream	Total Demand (Veh/hr)	Junction Arrivals (Veh)	Capacity (Veh/hr)	RFC	Throughput (Veh/hr)	Start queue (Veh)	End queue (Veh)	Delay (s)	Unsignalised level of service
B-AC	95	24	367	0.258	95	0.3	0.3	13.202	B
C-AB	62	15	531	0.116	62	0.1	0.1	7.663	A
C-A	644	161			644				
A-B	59	15			59				
A-C	511	128			511				

10:00 - 10:15

Stream	Total Demand (Veh/hr)	Junction Arrivals (Veh)	Capacity (Veh/hr)	RFC	Throughput (Veh/hr)	Start queue (Veh)	End queue (Veh)	Delay (s)	Unsignalised level of service
B-AC	77	19	406	0.190	78	0.3	0.2	10.967	B
C-AB	50	13	555	0.091	50	0.1	0.1	7.133	A
C-A	526	132			526				

A-B	49	12			49				
A-C	417	104			417				

10:15 - 10:30

Stream	Total Demand (Veh/hr)	Junction Arrivals (Veh)	Capacity (Veh/hr)	RFC	Throughput (Veh/hr)	Start queue (Veh)	End queue (Veh)	Delay (s)	Unsignalised level of service
B-AC	65	16	434	0.149	65	0.2	0.2	9.762	A
C-AB	42	11	572	0.074	42	0.1	0.1	6.790	A
C-A	441	110			441				
A-B	41	10			41				
A-C	349	87			349				

Queue Variation Results for each time segment**09:00 - 09:15**

Stream	Mean (Veh)	Q05 (Veh)	Q50 (Veh)	Q90 (Veh)	Q95 (Veh)	Percentile message	Marker message	Probability of reaching or exceeding marker	Probability of exactly reaching marker
B-AC	0.17	0.00	0.00	0.17	0.17			N/A	N/A
C-AB	0.08	0.00	0.00	0.08	0.08			N/A	N/A

09:15 - 09:30

Stream	Mean (Veh)	Q05 (Veh)	Q50 (Veh)	Q90 (Veh)	Q95 (Veh)	Percentile message	Marker message	Probability of reaching or exceeding marker	Probability of exactly reaching marker
B-AC	0.23	0.00	0.00	0.23	0.23			N/A	N/A
C-AB	0.10	0.03	0.25	0.45	0.48			N/A	N/A

09:30 - 09:45

Stream	Mean (Veh)	Q05 (Veh)	Q50 (Veh)	Q90 (Veh)	Q95 (Veh)	Percentile message	Marker message	Probability of reaching or exceeding marker	Probability of exactly reaching marker
B-AC	0.34	0.03	0.26	0.46	0.49			N/A	N/A
C-AB	0.13	0.03	0.26	0.47	0.49			N/A	N/A

09:45 - 10:00

Stream	Mean (Veh)	Q05 (Veh)	Q50 (Veh)	Q90 (Veh)	Q95 (Veh)	Percentile message	Marker message	Probability of reaching or exceeding marker	Probability of exactly reaching marker
B-AC	0.34	0.03	0.31	1.08	1.08			N/A	N/A
C-AB	0.13	0.03	0.25	0.45	0.48			N/A	N/A

10:00 - 10:15

Stream	Mean (Veh)	Q05 (Veh)	Q50 (Veh)	Q90 (Veh)	Q95 (Veh)	Percentile message	Marker message	Probability of reaching or exceeding marker	Probability of exactly reaching marker
B-AC	0.24	0.00	0.00	0.24	0.24			N/A	N/A
C-AB	0.10	0.00	0.00	0.10	0.10			N/A	N/A

10:15 - 10:30

Stream	Mean (Veh)	Q05 (Veh)	Q50 (Veh)	Q90 (Veh)	Q95 (Veh)	Percentile message	Marker message	Probability of reaching or exceeding marker	Probability of exactly reaching marker
B-AC	0.18	0.00	0.00	0.18	0.18			N/A	N/A
C-AB	0.08	0.00	0.00	0.08	0.08			N/A	N/A

2042 Faactored Base + 15yrs + Dev Flows x 2, AM

Data Errors and Warnings

Severity	Area	Item	Description
Warning	Demand Set Relationship	D4 - 2027 + Development Flows, AM	Demand Set relationships are chained. This may slow down the file.
Warning	Vehicle Mix		HV% is zero for all movements / time segments. Vehicle Mix matrix should be completed whether working in PCUs or Vehs. If HV% at the junction is genuinely zero, please ignore this warning.
Warning	Queue variations	Analysis Options	Queue percentiles may be unreliable if the mean queue in any time segment is very low or very high.

Junction Network

Junctions

Junction	Name	Junction type	Arm A Direction	Arm B Direction	Arm C Direction	Use circulating lanes	Junction Delay (s)	Junction LOS
1	Development Access	T-Junction	Two-way	Two-way	Two-way		3.46	A

Junction Network

Driving side	Lighting	Network residual capacity (%)	First arm reaching threshold	Network delay (s)	Network LOS
Left	Normal/unknown	12	Stream B-AC	3.46	A

Traffic Demand

Demand Set Details

ID	Scenario name	Time Period name	Traffic profile type	Start time (HH:mm)	Finish time (HH:mm)	Time segment length (min)	Run automatically	Relationship type	Relationship
D9	2042 Faactored Base + 15yrs + Dev Flows x 2	AM	ONE HOUR	09:00	10:30	15	✓	Simple	(D3*2)+D7

Demand overview (Traffic)

Arm	Linked arm	Profile type	Use O-D data	Average Demand (Veh/hr)	Scaling Factor (%)
A		ONE HOUR	✓	572	100.000
B		ONE HOUR	✓	172	100.000
C		ONE HOUR	✓	697	100.000

Origin-Destination Data

Demand (Veh/hr)

		To		
		A	B	C
From	A	0	108	464
	B	102	0	70
	C	585	112	0

Proportions

		To		
		A	B	C
From	A	0.00	0.19	0.81
	B	0.59	0.00	0.41
	C	0.84	0.16	0.00

Vehicle Mix

HV data entry mode	PCU Factor for a HV (PCU)
HV Percentages	2.00

Heavy Vehicle %

		To		
		A	B	C
From	A	0	0	0
	B	0	0	0
	C	0	0	0

Average PCU Per Veh

		To		
		A	B	C
From	A	1.000	1.000	1.000
	B	1.000	1.000	1.000
	C	1.000	1.000	1.000

Detailed Demand Data

Demand for each time segment

Arm	Time Segment	Demand (Veh/hr)	Demand in PCU (PCU/hr)
A	09:00-09:15	431	431
	09:15-09:30	514	514
	09:30-09:45	630	630

	09:45-10:00	630	630
	10:00-10:15	514	514
	10:15-10:30	431	431
B	09:00-09:15	129	129
	09:15-09:30	155	155
	09:30-09:45	189	189
	09:45-10:00	189	189
	10:00-10:15	155	155
	10:15-10:30	129	129
C	09:00-09:15	525	525
	09:15-09:30	627	627
	09:30-09:45	768	768
	09:45-10:00	768	768
	10:00-10:15	627	627
	10:15-10:30	525	525

Results

Results Summary for whole modelled period

Stream	Max RFC	Max Delay (s)	Max Queue (Veh)	Max 95th percentile Queue (Veh)	Max LOS	Average Demand (Veh/hr)	Total Junction Arrivals (Veh)
B-AC	0.55	23.09	1.2	5.2	C	158	237
C-AB	0.24	9.09	0.3	1.4	A	103	154
C-A						537	805
A-B						99	149
A-C						426	638

Main Results for each time segment

09:00 - 09:15

Stream	Total Demand (Veh/hr)	Junction Arrivals (Veh)	Capacity (Veh/hr)	RFC	Throughput (Veh/hr)	Start queue (Veh)	End queue (Veh)	Delay (s)	Unsignalised level of service
B-AC	129	32	420	0.308	128	0.0	0.4	12.252	B
C-AB	84	21	563	0.150	84	0.0	0.2	7.494	A
C-A	441	110			441				
A-B	81	20			81				
A-C	349	87			349				

09:15 - 09:30

Stream	Total Demand (Veh/hr)	Junction Arrivals (Veh)	Capacity (Veh/hr)	RFC	Throughput (Veh/hr)	Start queue (Veh)	End queue (Veh)	Delay (s)	Unsignalised level of service
B-AC	155	39	389	0.398	154	0.4	0.6	15.255	C
C-AB	101	25	545	0.185	101	0.2	0.2	8.103	A
C-A	526	132			526				
A-B	97	24			97				
A-C	417	104			417				

09:30 - 09:45

Stream	Total Demand (Veh/hr)	Junction Arrivals (Veh)	Capacity (Veh/hr)	RFC	Throughput (Veh/hr)	Start queue (Veh)	End queue (Veh)	Delay (s)	Unsignalised level of service
B-AC	189	47	345	0.549	187	0.6	1.2	22.544	C
C-AB	124	31	520	0.238	123	0.2	0.3	9.077	A
C-A	644	161			644				
A-B	119	30			119				
A-C	511	128			511				

09:45 - 10:00

Stream	Total Demand (Veh/hr)	Junction Arrivals (Veh)	Capacity (Veh/hr)	RFC	Throughput (Veh/hr)	Start queue (Veh)	End queue (Veh)	Delay (s)	Unsignalised level of service
B-AC	189	47	345	0.549	189	1.2	1.2	23.091	C
C-AB	124	31	520	0.238	124	0.3	0.3	9.092	A
C-A	644	161			644				
A-B	119	30			119				
A-C	511	128			511				

10:00 - 10:15

Stream	Total Demand (Veh/hr)	Junction Arrivals (Veh)	Capacity (Veh/hr)	RFC	Throughput (Veh/hr)	Start queue (Veh)	End queue (Veh)	Delay (s)	Unsignalised level of service
B-AC	155	39	389	0.398	157	1.2	0.7	15.639	C
C-AB	101	25	545	0.185	101	0.3	0.2	8.122	A
C-A	526	132			526				

A-B	97	24			97				
A-C	417	104			417				

10:15 - 10:30

Stream	Total Demand (Veh/hr)	Junction Arrivals (Veh)	Capacity (Veh/hr)	RFC	Throughput (Veh/hr)	Start queue (Veh)	End queue (Veh)	Delay (s)	Unsignalised level of service
B-AC	129	32	420	0.309	130	0.7	0.5	12.481	B
C-AB	84	21	563	0.150	85	0.2	0.2	7.524	A
C-A	441	110			441				
A-B	81	20			81				
A-C	349	87			349				

Queue Variation Results for each time segment**09:00 - 09:15**

Stream	Mean (Veh)	Q05 (Veh)	Q50 (Veh)	Q90 (Veh)	Q95 (Veh)	Percentile message	Marker message	Probability of reaching or exceeding marker	Probability of exactly reaching marker
B-AC	0.44	0.00	0.00	0.44	0.44			N/A	N/A
C-AB	0.17	0.00	0.00	0.17	0.17			N/A	N/A

09:15 - 09:30

Stream	Mean (Veh)	Q05 (Veh)	Q50 (Veh)	Q90 (Veh)	Q95 (Veh)	Percentile message	Marker message	Probability of reaching or exceeding marker	Probability of exactly reaching marker
B-AC	0.64	0.16	0.91	1.38	1.44			N/A	N/A
C-AB	0.22	0.00	0.00	0.22	0.22			N/A	N/A

09:30 - 09:45

Stream	Mean (Veh)	Q05 (Veh)	Q50 (Veh)	Q90 (Veh)	Q95 (Veh)	Percentile message	Marker message	Probability of reaching or exceeding marker	Probability of exactly reaching marker
B-AC	1.16	0.03	0.28	1.16	3.79			N/A	N/A
C-AB	0.31	0.03	0.26	0.46	0.49			N/A	N/A

09:45 - 10:00

Stream	Mean (Veh)	Q05 (Veh)	Q50 (Veh)	Q90 (Veh)	Q95 (Veh)	Percentile message	Marker message	Probability of reaching or exceeding marker	Probability of exactly reaching marker
B-AC	1.19	0.03	0.29	1.49	5.21			N/A	N/A
C-AB	0.31	0.03	0.31	1.10	1.41			N/A	N/A

10:00 - 10:15

Stream	Mean (Veh)	Q05 (Veh)	Q50 (Veh)	Q90 (Veh)	Q95 (Veh)	Percentile message	Marker message	Probability of reaching or exceeding marker	Probability of exactly reaching marker
B-AC	0.68	0.05	0.58	1.43	1.43			N/A	N/A
C-AB	0.23	0.00	0.00	0.23	0.23			N/A	N/A

10:15 - 10:30

Stream	Mean (Veh)	Q05 (Veh)	Q50 (Veh)	Q90 (Veh)	Q95 (Veh)	Percentile message	Marker message	Probability of reaching or exceeding marker	Probability of exactly reaching marker
B-AC	0.45	0.04	0.37	1.29	1.46			N/A	N/A
C-AB	0.18	0.00	0.00	0.18	0.18			N/A	N/A

2023, PM

Data Errors and Warnings

Severity	Area	Item	Description
Warning	Demand Set Relationship	D4 - 2027 + Development Flows, AM	Demand Set relationships are chained. This may slow down the file.
Warning	Vehicle Mix		HV% is zero for all movements / time segments. Vehicle Mix matrix should be completed whether working in PCUs or Vehs. If HV% at the junction is genuinely zero, please ignore this warning.
Warning	Queue variations	Analysis Options	Queue percentiles may be unreliable if the mean queue in any time segment is very low or very high.

Junction Network

Junctions

Junction	Name	Junction type	Arm A Direction	Arm B Direction	Arm C Direction	Use circulating lanes	Junction Delay (s)	Junction LOS
1	Development Access	T-Junction	Two-way	Two-way	Two-way		0.00	A

Junction Network

Driving side	Lighting	Network residual capacity (%)	First arm reaching threshold	Network delay (s)	Network LOS
Left	Normal/unknown	900		0.00	A

Traffic Demand

Demand Set Details

ID	Scenario name	Time Period name	Traffic profile type	Start time (HH:mm)	Finish time (HH:mm)	Time segment length (min)	Run automatically
D10	2023	PM	ONE HOUR	15:00	16:30	15	✓

Demand overview (Traffic)

Arm	Linked arm	Profile type	Use O-D data	Average Demand (Veh/hr)	Scaling Factor (%)
A		ONE HOUR	✓	501	100.000
B		ONE HOUR	✓	0	100.000
C		ONE HOUR	✓	820	100.000

Origin-Destination Data

Demand (Veh/hr)

		To		
		A	B	C
From	A	0	0	501
	B	0	0	0
	C	820	0	0

Proportions

		To		
		A	B	C
From	A	0.00	0.00	1.00
	B	0.33	0.33	0.33
	C	1.00	0.00	0.00

Vehicle Mix

HV data entry mode	PCU Factor for a HV (PCU)
HV Percentages	2.00

Heavy Vehicle %

		To		
		A	B	C
From	A	0	0	0
	B	0	0	0
	C	0	0	0

Average PCU Per Veh

		To		
		A	B	C
From	A	1.000	1.000	1.000
	B	1.000	1.000	1.000
	C	1.000	1.000	1.000

Detailed Demand Data

Demand for each time segment

Arm	Time Segment	Demand (Veh/hr)	Demand in PCU (PCU/hr)
A	15:00-15:15	377	377
	15:15-15:30	450	450
	15:30-15:45	552	552
	15:45-16:00	552	552
	16:00-16:15	450	450

	16:15-16:30	377	377
B	15:00-15:15	0	0
	15:15-15:30	0	0
	15:30-15:45	0	0
	15:45-16:00	0	0
	16:00-16:15	0	0
	16:15-16:30	0	0
C	15:00-15:15	617	617
	15:15-15:30	737	737
	15:30-15:45	903	903
	15:45-16:00	903	903
	16:00-16:15	737	737
	16:15-16:30	617	617

Results

Results Summary for whole modelled period

Stream	Max RFC	Max Delay (s)	Max Queue (Veh)	Max 95th percentile Queue (Veh)	Max LOS	Average Demand (Veh/hr)	Total Junction Arrivals (Veh)
B-AC	0.00	0.00	0.0	~1	A	0	0
C-AB	0.00	0.00	0.0	~1	A	0	0
C-A						752	1129
A-B						0	0
A-C						460	690

Main Results for each time segment

15:00 - 15:15

Stream	Total Demand (Veh/hr)	Junction Arrivals (Veh)	Capacity (Veh/hr)	RFC	Throughput (Veh/hr)	Start queue (Veh)	End queue (Veh)	Delay (s)	Unsignalised level of service
B-AC	0	0	440	0.000	0	0.0	0.0	0.000	A
C-AB	0	0	1151	0.000	0	0.0	0.0	0.000	A
C-A	617	154			617				
A-B	0	0			0				
A-C	377	94			377				

15:15 - 15:30

Stream	Total Demand (Veh/hr)	Junction Arrivals (Veh)	Capacity (Veh/hr)	RFC	Throughput (Veh/hr)	Start queue (Veh)	End queue (Veh)	Delay (s)	Unsignalised level of service
B-AC	0	0	411	0.000	0	0.0	0.0	0.000	A
C-AB	0	0	1117	0.000	0	0.0	0.0	0.000	A
C-A	737	184			737				
A-B	0	0			0				
A-C	450	113			450				

15:30 - 15:45

Stream	Total Demand (Veh/hr)	Junction Arrivals (Veh)	Capacity (Veh/hr)	RFC	Throughput (Veh/hr)	Start queue (Veh)	End queue (Veh)	Delay (s)	Unsignalised level of service
B-AC	0	0	369	0.000	0	0.0	0.0	0.000	A
C-AB	0	0	1071	0.000	0	0.0	0.0	0.000	A
C-A	903	226			903				
A-B	0	0			0				
A-C	552	138			552				

15:45 - 16:00

Stream	Total Demand (Veh/hr)	Junction Arrivals (Veh)	Capacity (Veh/hr)	RFC	Throughput (Veh/hr)	Start queue (Veh)	End queue (Veh)	Delay (s)	Unsignalised level of service
B-AC	0	0	369	0.000	0	0.0	0.0	0.000	A
C-AB	0	0	1071	0.000	0	0.0	0.0	0.000	A
C-A	903	226			903				
A-B	0	0			0				
A-C	552	138			552				

16:00 - 16:15

Stream	Total Demand (Veh/hr)	Junction Arrivals (Veh)	Capacity (Veh/hr)	RFC	Throughput (Veh/hr)	Start queue (Veh)	End queue (Veh)	Delay (s)	Unsignalised level of service
B-AC	0	0	411	0.000	0	0.0	0.0	0.000	A
C-AB	0	0	1117	0.000	0	0.0	0.0	0.000	A
C-A	737	184			737				
A-B	0	0			0				
A-C	450	113			450				

16:15 - 16:30

Stream	Total Demand (Veh/hr)	Junction Arrivals (Veh)	Capacity (Veh/hr)	RFC	Throughput (Veh/hr)	Start queue (Veh)	End queue (Veh)	Delay (s)	Unsignalised level of service
B-AC	0	0	440	0.000	0	0.0	0.0	0.000	A
C-AB	0	0	1151	0.000	0	0.0	0.0	0.000	A
C-A	617	154			617				
A-B	0	0			0				
A-C	377	94			377				

Queue Variation Results for each time segment

15:00 - 15:15

Stream	Mean (Veh)	Q05 (Veh)	Q50 (Veh)	Q90 (Veh)	Q95 (Veh)	Percentile message	Marker message	Probability of reaching or exceeding marker	Probability of exactly reaching marker
B-AC	0.00	0.00	0.00	0.00	0.00			N/A	N/A
C-AB	0.00	0.00	0.00	0.00	0.00			N/A	N/A

15:15 - 15:30

Stream	Mean (Veh)	Q05 (Veh)	Q50 (Veh)	Q90 (Veh)	Q95 (Veh)	Percentile message	Marker message	Probability of reaching or exceeding marker	Probability of exactly reaching marker
B-AC	0.00	0.00	0.00	0.00	0.00			N/A	N/A
C-AB	0.00	0.00	0.00	0.00	0.00			N/A	N/A

15:30 - 15:45

Stream	Mean (Veh)	Q05 (Veh)	Q50 (Veh)	Q90 (Veh)	Q95 (Veh)	Percentile message	Marker message	Probability of reaching or exceeding marker	Probability of exactly reaching marker
B-AC	0.00	0.00	0.00	0.00	0.00			N/A	N/A
C-AB	0.00	0.00	0.00	0.00	0.00			N/A	N/A

15:45 - 16:00

Stream	Mean (Veh)	Q05 (Veh)	Q50 (Veh)	Q90 (Veh)	Q95 (Veh)	Percentile message	Marker message	Probability of reaching or exceeding marker	Probability of exactly reaching marker
B-AC	0.00	0.00	0.00	0.00	0.00			N/A	N/A
C-AB	0.00	0.00	0.00	0.00	0.00			N/A	N/A

16:00 - 16:15

Stream	Mean (Veh)	Q05 (Veh)	Q50 (Veh)	Q90 (Veh)	Q95 (Veh)	Percentile message	Marker message	Probability of reaching or exceeding marker	Probability of exactly reaching marker
B-AC	0.00	0.00	0.00	0.00	0.00			N/A	N/A
C-AB	0.00	0.00	0.00	0.00	0.00			N/A	N/A

16:15 - 16:30

Stream	Mean (Veh)	Q05 (Veh)	Q50 (Veh)	Q90 (Veh)	Q95 (Veh)	Percentile message	Marker message	Probability of reaching or exceeding marker	Probability of exactly reaching marker
B-AC	0.00	0.00	0.00	0.00	0.00			N/A	N/A
C-AB	0.00	0.00	0.00	0.00	0.00			N/A	N/A

2027 - Opening Year, PM

Data Errors and Warnings

Severity	Area	Item	Description
Warning	Demand Set Relationship	D4 - 2027 + Development Flows, AM	Demand Set relationships are chained. This may slow down the file.
Warning	Vehicle Mix		HV% is zero for all movements / time segments. Vehicle Mix matrix should be completed whether working in PCUs or Vehs. If HV% at the junction is genuinely zero, please ignore this warning.
Warning	Queue variations	Analysis Options	Queue percentiles may be unreliable if the mean queue in any time segment is very low or very high.

Junction Network

Junctions

Junction	Name	Junction type	Arm A Direction	Arm B Direction	Arm C Direction	Use circulating lanes	Junction Delay (s)	Junction LOS
1	Development Access	T-Junction	Two-way	Two-way	Two-way		0.00	A

Junction Network

Driving side	Lighting	Network residual capacity (%)	First arm reaching threshold	Network delay (s)	Network LOS
Left	Normal/unknown	900		0.00	A

Traffic Demand

Demand Set Details

ID	Scenario name	Time Period name	Traffic profile type	Start time (HH:mm)	Finish time (HH:mm)	Time segment length (min)	Run automatically	Relationship type	Relationship
D11	2027 - Opening Year	PM	ONE HOUR	15:00	16:30	15	✓	Simple	D10*G1

Demand overview (Traffic)

Arm	Linked arm	Profile type	Use O-D data	Average Demand (Veh/hr)	Scaling Factor (%)
A		ONE HOUR	✓	526	100.000
B		ONE HOUR	✓	0	100.000
C		ONE HOUR	✓	860	100.000

Origin-Destination Data

Demand (Veh/hr)

	To			
	A	B	C	
From	A	0	0	526
	B	0	0	0
	C	860	0	0

Proportions

	To			
	A	B	C	
From	A	0.00	0.00	1.00
	B	0.33	0.33	0.33
	C	1.00	0.00	0.00

Vehicle Mix

HV data entry mode	PCU Factor for a HV (PCU)
HV Percentages	2.00

Heavy Vehicle %

	To			
	A	B	C	
From	A	0	0	0
	B	0	0	0
	C	0	0	0

Average PCU Per Veh

	To			
	A	B	C	
From	A	1.000	1.000	1.000
	B	1.000	1.000	1.000
	C	1.000	1.000	1.000

Detailed Demand Data

Demand for each time segment

Arm	Time Segment	Demand (Veh/hr)	Demand in PCU (PCU/hr)
A	15:00-15:15	396	396
	15:15-15:30	472	472
	15:30-15:45	579	579
	15:45-16:00	579	579
	16:00-16:15	472	472

	16:15-16:30	396	396
B	15:00-15:15	0	0
	15:15-15:30	0	0
	15:30-15:45	0	0
	15:45-16:00	0	0
	16:00-16:15	0	0
	16:15-16:30	0	0
C	15:00-15:15	648	648
	15:15-15:30	773	773
	15:30-15:45	947	947
	15:45-16:00	947	947
	16:00-16:15	773	773
	16:15-16:30	648	648

Results

Results Summary for whole modelled period

Stream	Max RFC	Max Delay (s)	Max Queue (Veh)	Max 95th percentile Queue (Veh)	Max LOS	Average Demand (Veh/hr)	Total Junction Arrivals (Veh)
B-AC	0.00	0.00	0.0	~1	A	0	0
C-AB	0.00	0.00	0.0	~1	A	0	0
C-A						789	1184
A-B						0	0
A-C						482	723

Main Results for each time segment

15:00 - 15:15

Stream	Total Demand (Veh/hr)	Junction Arrivals (Veh)	Capacity (Veh/hr)	RFC	Throughput (Veh/hr)	Start queue (Veh)	End queue (Veh)	Delay (s)	Unsignalised level of service
B-AC	0	0	433	0.000	0	0.0	0.0	0.000	A
C-AB	0	0	1142	0.000	0	0.0	0.0	0.000	A
C-A	648	162			648				
A-B	0	0			0				
A-C	396	99			396				

15:15 - 15:30

Stream	Total Demand (Veh/hr)	Junction Arrivals (Veh)	Capacity (Veh/hr)	RFC	Throughput (Veh/hr)	Start queue (Veh)	End queue (Veh)	Delay (s)	Unsignalised level of service
B-AC	0	0	402	0.000	0	0.0	0.0	0.000	A
C-AB	0	0	1107	0.000	0	0.0	0.0	0.000	A
C-A	773	193			773				
A-B	0	0			0				
A-C	472	118			472				

15:30 - 15:45

Stream	Total Demand (Veh/hr)	Junction Arrivals (Veh)	Capacity (Veh/hr)	RFC	Throughput (Veh/hr)	Start queue (Veh)	End queue (Veh)	Delay (s)	Unsignalised level of service
B-AC	0	0	357	0.000	0	0.0	0.0	0.000	A
C-AB	0	0	1059	0.000	0	0.0	0.0	0.000	A
C-A	947	237			947				
A-B	0	0			0				
A-C	579	145			579				

15:45 - 16:00

Stream	Total Demand (Veh/hr)	Junction Arrivals (Veh)	Capacity (Veh/hr)	RFC	Throughput (Veh/hr)	Start queue (Veh)	End queue (Veh)	Delay (s)	Unsignalised level of service
B-AC	0	0	357	0.000	0	0.0	0.0	0.000	A
C-AB	0	0	1059	0.000	0	0.0	0.0	0.000	A
C-A	947	237			947				
A-B	0	0			0				
A-C	579	145			579				

16:00 - 16:15

Stream	Total Demand (Veh/hr)	Junction Arrivals (Veh)	Capacity (Veh/hr)	RFC	Throughput (Veh/hr)	Start queue (Veh)	End queue (Veh)	Delay (s)	Unsignalised level of service
B-AC	0	0	402	0.000	0	0.0	0.0	0.000	A
C-AB	0	0	1107	0.000	0	0.0	0.0	0.000	A
C-A	773	193			773				
A-B	0	0			0				
A-C	472	118			472				

16:15 - 16:30

Stream	Total Demand (Veh/hr)	Junction Arrivals (Veh)	Capacity (Veh/hr)	RFC	Throughput (Veh/hr)	Start queue (Veh)	End queue (Veh)	Delay (s)	Unsignalised level of service
B-AC	0	0	433	0.000	0	0.0	0.0	0.000	A
C-AB	0	0	1142	0.000	0	0.0	0.0	0.000	A
C-A	648	162			648				
A-B	0	0			0				
A-C	396	99			396				

Queue Variation Results for each time segment

15:00 - 15:15

Stream	Mean (Veh)	Q05 (Veh)	Q50 (Veh)	Q90 (Veh)	Q95 (Veh)	Percentile message	Marker message	Probability of reaching or exceeding marker	Probability of exactly reaching marker
B-AC	0.00	0.00	0.00	0.00	0.00			N/A	N/A
C-AB	0.00	0.00	0.00	0.00	0.00			N/A	N/A

15:15 - 15:30

Stream	Mean (Veh)	Q05 (Veh)	Q50 (Veh)	Q90 (Veh)	Q95 (Veh)	Percentile message	Marker message	Probability of reaching or exceeding marker	Probability of exactly reaching marker
B-AC	0.00	0.00	0.00	0.00	0.00			N/A	N/A
C-AB	0.00	0.00	0.00	0.00	0.00			N/A	N/A

15:30 - 15:45

Stream	Mean (Veh)	Q05 (Veh)	Q50 (Veh)	Q90 (Veh)	Q95 (Veh)	Percentile message	Marker message	Probability of reaching or exceeding marker	Probability of exactly reaching marker
B-AC	0.00	0.00	0.00	0.00	0.00			N/A	N/A
C-AB	0.00	0.00	0.00	0.00	0.00			N/A	N/A

15:45 - 16:00

Stream	Mean (Veh)	Q05 (Veh)	Q50 (Veh)	Q90 (Veh)	Q95 (Veh)	Percentile message	Marker message	Probability of reaching or exceeding marker	Probability of exactly reaching marker
B-AC	0.00	0.00	0.00	0.00	0.00			N/A	N/A
C-AB	0.00	0.00	0.00	0.00	0.00			N/A	N/A

16:00 - 16:15

Stream	Mean (Veh)	Q05 (Veh)	Q50 (Veh)	Q90 (Veh)	Q95 (Veh)	Percentile message	Marker message	Probability of reaching or exceeding marker	Probability of exactly reaching marker
B-AC	0.00	0.00	0.00	0.00	0.00			N/A	N/A
C-AB	0.00	0.00	0.00	0.00	0.00			N/A	N/A

16:15 - 16:30

Stream	Mean (Veh)	Q05 (Veh)	Q50 (Veh)	Q90 (Veh)	Q95 (Veh)	Percentile message	Marker message	Probability of reaching or exceeding marker	Probability of exactly reaching marker
B-AC	0.00	0.00	0.00	0.00	0.00			N/A	N/A
C-AB	0.00	0.00	0.00	0.00	0.00			N/A	N/A

Development Flows, PM

Data Errors and Warnings

Severity	Area	Item	Description
Warning	Demand Set Relationship	D4 - 2027 + Development Flows, AM	Demand Set relationships are chained. This may slow down the file.
Warning	Vehicle Mix		HV% is zero for all movements / time segments. Vehicle Mix matrix should be completed whether working in PCUs or Vehs. If HV% at the junction is genuinely zero, please ignore this warning.
Warning	Queue variations	Analysis Options	Queue percentiles may be unreliable if the mean queue in any time segment is very low or very high.

Junction Network

Junctions

Junction	Name	Junction type	Arm A Direction	Arm B Direction	Arm C Direction	Use circulating lanes	Junction Delay (s)	Junction LOS
1	Development Access	T-Junction	Two-way	Two-way	Two-way		4.53	A

Junction Network

Driving side	Lighting	Network residual capacity (%)	First arm reaching threshold	Network delay (s)	Network LOS
Left	Normal/unknown	435	Stream B-AC	4.53	A

Traffic Demand

Demand Set Details

ID	Scenario name	Time Period name	Traffic profile type	Start time (HH:mm)	Finish time (HH:mm)	Time segment length (min)	Run automatically
D12	Development Flows	PM	ONE HOUR	15:00	16:30	15	✓

Demand overview (Traffic)

Arm	Linked arm	Profile type	Use O-D data	Average Demand (Veh/hr)	Scaling Factor (%)
A		ONE HOUR	✓	62	100.000
B		ONE HOUR	✓	63	100.000
C		ONE HOUR	✓	62	100.000

Origin-Destination Data

Demand (Veh/hr)

		To		
		A	B	C
From	A	0	62	0
	B	32	0	31
	C	0	62	0

Proportions

		To		
		A	B	C
From	A	0.00	1.00	0.00
	B	0.51	0.00	0.49
	C	0.00	1.00	0.00

Vehicle Mix

HV data entry mode	PCU Factor for a HV (PCU)
HV Percentages	2.00

Heavy Vehicle %

		To		
		A	B	C
From	A	0	0	0
	B	0	0	0
	C	0	0	0

Average PCU Per Veh

		To		
		A	B	C
From	A	1.000	1.000	1.000
	B	1.000	1.000	1.000
	C	1.000	1.000	1.000

Detailed Demand Data

Demand for each time segment

Arm	Time Segment	Demand (Veh/hr)	Demand in PCU (PCU/hr)
A	15:00-15:15	47	47
	15:15-15:30	56	56
	15:30-15:45	68	68
	15:45-16:00	68	68
	16:00-16:15	56	56

	16:15-16:30	47	47
B	15:00-15:15	47	47
	15:15-15:30	57	57
	15:30-15:45	69	69
	15:45-16:00	69	69
	16:00-16:15	57	57
	16:15-16:30	47	47
C	15:00-15:15	47	47
	15:15-15:30	56	56
	15:30-15:45	68	68
	15:45-16:00	68	68
	16:00-16:15	56	56
	16:15-16:30	47	47

Results

Results Summary for whole modelled period

Stream	Max RFC	Max Delay (s)	Max Queue (Veh)	Max 95th percentile Queue (Veh)	Max LOS	Average Demand (Veh/hr)	Total Junction Arrivals (Veh)
B-AC	0.12	7.32	0.1	0.5	A	58	87
C-AB	0.11	6.23	0.1	0.5	A	57	85
C-A						0	0
A-B						57	85
A-C						0	0

Main Results for each time segment

15:00 - 15:15

Stream	Total Demand (Veh/hr)	Junction Arrivals (Veh)	Capacity (Veh/hr)	RFC	Throughput (Veh/hr)	Start queue (Veh)	End queue (Veh)	Delay (s)	Unsignalised level of service
B-AC	47	12	567	0.084	47	0.0	0.1	6.919	A
C-AB	47	12	651	0.072	46	0.0	0.1	5.953	A
C-A	0	0			0				
A-B	47	12			47				
A-C	0	0			0				

15:15 - 15:30

Stream	Total Demand (Veh/hr)	Junction Arrivals (Veh)	Capacity (Veh/hr)	RFC	Throughput (Veh/hr)	Start queue (Veh)	End queue (Veh)	Delay (s)	Unsignalised level of service
B-AC	57	14	564	0.100	57	0.1	0.1	7.089	A
C-AB	56	14	649	0.086	56	0.1	0.1	6.070	A
C-A	0	0			0				
A-B	56	14			56				
A-C	0	0			0				

15:30 - 15:45

Stream	Total Demand (Veh/hr)	Junction Arrivals (Veh)	Capacity (Veh/hr)	RFC	Throughput (Veh/hr)	Start queue (Veh)	End queue (Veh)	Delay (s)	Unsignalised level of service
B-AC	69	17	561	0.124	69	0.1	0.1	7.321	A
C-AB	68	17	646	0.106	68	0.1	0.1	6.231	A
C-A	0	0			0				
A-B	68	17			68				
A-C	0	0			0				

15:45 - 16:00

Stream	Total Demand (Veh/hr)	Junction Arrivals (Veh)	Capacity (Veh/hr)	RFC	Throughput (Veh/hr)	Start queue (Veh)	End queue (Veh)	Delay (s)	Unsignalised level of service
B-AC	69	17	561	0.124	69	0.1	0.1	7.325	A
C-AB	68	17	646	0.106	68	0.1	0.1	6.231	A
C-A	0	0			0				
A-B	68	17			68				
A-C	0	0			0				

16:00 - 16:15

Stream	Total Demand (Veh/hr)	Junction Arrivals (Veh)	Capacity (Veh/hr)	RFC	Throughput (Veh/hr)	Start queue (Veh)	End queue (Veh)	Delay (s)	Unsignalised level of service
B-AC	57	14	564	0.100	57	0.1	0.1	7.095	A
C-AB	56	14	649	0.086	56	0.1	0.1	6.071	A
C-A	0	0			0				
A-B	56	14			56				
A-C	0	0			0				

16:15 - 16:30

Stream	Total Demand (Veh/hr)	Junction Arrivals (Veh)	Capacity (Veh/hr)	RFC	Throughput (Veh/hr)	Start queue (Veh)	End queue (Veh)	Delay (s)	Unsignalised level of service
B-AC	47	12	567	0.084	48	0.1	0.1	6.933	A
C-AB	47	12	651	0.072	47	0.1	0.1	5.961	A
C-A	0	0			0				
A-B	47	12			47				
A-C	0	0			0				

Queue Variation Results for each time segment

15:00 - 15:15

Stream	Mean (Veh)	Q05 (Veh)	Q50 (Veh)	Q90 (Veh)	Q95 (Veh)	Percentile message	Marker message	Probability of reaching or exceeding marker	Probability of exactly reaching marker
B-AC	0.09	0.00	0.00	0.09	0.09			N/A	N/A
C-AB	0.08	0.00	0.00	0.08	0.08			N/A	N/A

15:15 - 15:30

Stream	Mean (Veh)	Q05 (Veh)	Q50 (Veh)	Q90 (Veh)	Q95 (Veh)	Percentile message	Marker message	Probability of reaching or exceeding marker	Probability of exactly reaching marker
B-AC	0.11	0.00	0.00	0.11	0.11			N/A	N/A
C-AB	0.09	0.03	0.25	0.45	0.48			N/A	N/A

15:30 - 15:45

Stream	Mean (Veh)	Q05 (Veh)	Q50 (Veh)	Q90 (Veh)	Q95 (Veh)	Percentile message	Marker message	Probability of reaching or exceeding marker	Probability of exactly reaching marker
B-AC	0.14	0.03	0.26	0.46	0.49			N/A	N/A
C-AB	0.12	0.03	0.26	0.46	0.49			N/A	N/A

15:45 - 16:00

Stream	Mean (Veh)	Q05 (Veh)	Q50 (Veh)	Q90 (Veh)	Q95 (Veh)	Percentile message	Marker message	Probability of reaching or exceeding marker	Probability of exactly reaching marker
B-AC	0.14	0.03	0.25	0.45	0.48			N/A	N/A
C-AB	0.12	0.03	0.25	0.45	0.48			N/A	N/A

16:00 - 16:15

Stream	Mean (Veh)	Q05 (Veh)	Q50 (Veh)	Q90 (Veh)	Q95 (Veh)	Percentile message	Marker message	Probability of reaching or exceeding marker	Probability of exactly reaching marker
B-AC	0.11	0.00	0.00	0.11	0.11			N/A	N/A
C-AB	0.09	0.00	0.00	0.09	0.09			N/A	N/A

16:15 - 16:30

Stream	Mean (Veh)	Q05 (Veh)	Q50 (Veh)	Q90 (Veh)	Q95 (Veh)	Percentile message	Marker message	Probability of reaching or exceeding marker	Probability of exactly reaching marker
B-AC	0.09	0.00	0.00	0.09	0.09			N/A	N/A
C-AB	0.08	0.00	0.00	0.08	0.08			N/A	N/A

2027 + Development Flows, PM

Data Errors and Warnings

Severity	Area	Item	Description
Warning	Demand Set Relationship	D4 - 2027 + Development Flows, AM	Demand Set relationships are chained. This may slow down the file.
Warning	Vehicle Mix		HV% is zero for all movements / time segments. Vehicle Mix matrix should be completed whether working in PCUs or Vehs. If HV% at the junction is genuinely zero, please ignore this warning.
Warning	Queue variations	Analysis Options	Queue percentiles may be unreliable if the mean queue in any time segment is very low or very high.

Junction Network

Junctions

Junction	Name	Junction type	Arm A Direction	Arm B Direction	Arm C Direction	Use circulating lanes	Junction Delay (s)	Junction LOS
1	Development Access	T-Junction	Two-way	Two-way	Two-way		0.87	A

Junction Network

Driving side	Lighting	Network residual capacity (%)	First arm reaching threshold	Network delay (s)	Network LOS
Left	Normal/unknown	41	Stream B-AC	0.87	A

Traffic Demand

Demand Set Details

ID	Scenario name	Time Period name	Traffic profile type	Start time (HH:mm)	Finish time (HH:mm)	Time segment length (min)	Run automatically	Relationship type	Relationship
D13	2027 + Development Flows	PM	ONE HOUR	15:00	16:30	15	✓	Simple	D11+D12

Demand overview (Traffic)

Arm	Linked arm	Profile type	Use O-D data	Average Demand (Veh/hr)	Scaling Factor (%)
A		ONE HOUR	✓	588	100.000
B		ONE HOUR	✓	63	100.000
C		ONE HOUR	✓	922	100.000

Origin-Destination Data

Demand (Veh/hr)

		To		
		A	B	C
From	A	0	62	526
	B	32	0	31
	C	860	62	0

Proportions

		To		
		A	B	C
From	A	0.00	0.11	0.89
	B	0.51	0.00	0.49
	C	0.93	0.07	0.00

Vehicle Mix

HV data entry mode	PCU Factor for a HV (PCU)
HV Percentages	2.00

Heavy Vehicle %

		To		
		A	B	C
From	A	0	0	0
	B	0	0	0
	C	0	0	0

Average PCU Per Veh

		To		
		A	B	C
From	A	1.000	1.000	1.000
	B	1.000	1.000	1.000
	C	1.000	1.000	1.000

Detailed Demand Data

Demand for each time segment

Arm	Time Segment	Demand (Veh/hr)	Demand in PCU (PCU/hr)
A	15:00-15:15	442	442
	15:15-15:30	528	528
	15:30-15:45	647	647
	15:45-16:00	647	647
	16:00-16:15	528	528

	16:15-16:30	442	442
B	15:00-15:15	47	47
	15:15-15:30	57	57
	15:30-15:45	69	69
	15:45-16:00	69	69
	16:00-16:15	57	57
	16:15-16:30	47	47
C	15:00-15:15	694	694
	15:15-15:30	829	829
	15:30-15:45	1015	1015
	15:45-16:00	1015	1015
	16:00-16:15	829	829
	16:15-16:30	694	694

Results

Results Summary for whole modelled period

Stream	Max RFC	Max Delay (s)	Max Queue (Veh)	Max 95th percentile Queue (Veh)	Max LOS	Average Demand (Veh/hr)	Total Junction Arrivals (Veh)
B-AC	0.21	13.81	0.3	1.2	B	58	87
C-AB	0.13	8.08	0.2	0.5	A	57	85
C-A						789	1184
A-B						57	85
A-C						482	723

Main Results for each time segment

15:00 - 15:15

Stream	Total Demand (Veh/hr)	Junction Arrivals (Veh)	Capacity (Veh/hr)	RFC	Throughput (Veh/hr)	Start queue (Veh)	End queue (Veh)	Delay (s)	Unsignalised level of service
B-AC	47	12	416	0.114	47	0.0	0.1	9.749	A
C-AB	47	12	560	0.083	46	0.0	0.1	6.997	A
C-A	648	162			648				
A-B	47	12			47				
A-C	396	99			396				

15:15 - 15:30

Stream	Total Demand (Veh/hr)	Junction Arrivals (Veh)	Capacity (Veh/hr)	RFC	Throughput (Veh/hr)	Start queue (Veh)	End queue (Veh)	Delay (s)	Unsignalised level of service
B-AC	57	14	381	0.149	56	0.1	0.2	11.094	B
C-AB	56	14	541	0.103	56	0.1	0.1	7.416	A
C-A	773	193			773				
A-B	56	14			56				
A-C	472	118			472				

15:30 - 15:45

Stream	Total Demand (Veh/hr)	Junction Arrivals (Veh)	Capacity (Veh/hr)	RFC	Throughput (Veh/hr)	Start queue (Veh)	End queue (Veh)	Delay (s)	Unsignalised level of service
B-AC	69	17	330	0.210	69	0.2	0.3	13.771	B
C-AB	68	17	514	0.133	68	0.1	0.2	8.072	A
C-A	947	237			947				
A-B	68	17			68				
A-C	579	145			579				

15:45 - 16:00

Stream	Total Demand (Veh/hr)	Junction Arrivals (Veh)	Capacity (Veh/hr)	RFC	Throughput (Veh/hr)	Start queue (Veh)	End queue (Veh)	Delay (s)	Unsignalised level of service
B-AC	69	17	330	0.210	69	0.3	0.3	13.811	B
C-AB	68	17	514	0.133	68	0.2	0.2	8.076	A
C-A	947	237			947				
A-B	68	17			68				
A-C	579	145			579				

16:00 - 16:15

Stream	Total Demand (Veh/hr)	Junction Arrivals (Veh)	Capacity (Veh/hr)	RFC	Throughput (Veh/hr)	Start queue (Veh)	End queue (Veh)	Delay (s)	Unsignalised level of service
B-AC	57	14	381	0.149	57	0.3	0.2	11.131	B
C-AB	56	14	541	0.103	56	0.2	0.1	7.426	A
C-A	773	193			773				
A-B	56	14			56				
A-C	472	118			472				

16:15 - 16:30

Stream	Total Demand (Veh/hr)	Junction Arrivals (Veh)	Capacity (Veh/hr)	RFC	Throughput (Veh/hr)	Start queue (Veh)	End queue (Veh)	Delay (s)	Unsignalised level of service
B-AC	47	12	416	0.114	48	0.2	0.1	9.787	A
C-AB	47	12	560	0.083	47	0.1	0.1	7.008	A
C-A	648	162			648				
A-B	47	12			47				
A-C	396	99			396				

Queue Variation Results for each time segment

15:00 - 15:15

Stream	Mean (Veh)	Q05 (Veh)	Q50 (Veh)	Q90 (Veh)	Q95 (Veh)	Percentile message	Marker message	Probability of reaching or exceeding marker	Probability of exactly reaching marker
B-AC	0.13	0.00	0.00	0.13	0.13			N/A	N/A
C-AB	0.09	0.00	0.00	0.09	0.09			N/A	N/A

15:15 - 15:30

Stream	Mean (Veh)	Q05 (Veh)	Q50 (Veh)	Q90 (Veh)	Q95 (Veh)	Percentile message	Marker message	Probability of reaching or exceeding marker	Probability of exactly reaching marker
B-AC	0.17	0.00	0.00	0.17	0.17			N/A	N/A
C-AB	0.11	0.00	0.00	0.11	0.11			N/A	N/A

15:30 - 15:45

Stream	Mean (Veh)	Q05 (Veh)	Q50 (Veh)	Q90 (Veh)	Q95 (Veh)	Percentile message	Marker message	Probability of reaching or exceeding marker	Probability of exactly reaching marker
B-AC	0.26	0.03	0.26	0.47	0.49			N/A	N/A
C-AB	0.15	0.03	0.26	0.46	0.49			N/A	N/A

15:45 - 16:00

Stream	Mean (Veh)	Q05 (Veh)	Q50 (Veh)	Q90 (Veh)	Q95 (Veh)	Percentile message	Marker message	Probability of reaching or exceeding marker	Probability of exactly reaching marker
B-AC	0.26	0.03	0.30	0.91	1.24			N/A	N/A
C-AB	0.15	0.03	0.25	0.45	0.48			N/A	N/A

16:00 - 16:15

Stream	Mean (Veh)	Q05 (Veh)	Q50 (Veh)	Q90 (Veh)	Q95 (Veh)	Percentile message	Marker message	Probability of reaching or exceeding marker	Probability of exactly reaching marker
B-AC	0.18	0.00	0.00	0.18	0.18			N/A	N/A
C-AB	0.12	0.00	0.00	0.12	0.12			N/A	N/A

16:15 - 16:30

Stream	Mean (Veh)	Q05 (Veh)	Q50 (Veh)	Q90 (Veh)	Q95 (Veh)	Percentile message	Marker message	Probability of reaching or exceeding marker	Probability of exactly reaching marker
B-AC	0.13	0.00	0.00	0.13	0.13			N/A	N/A
C-AB	0.09	0.00	0.00	0.09	0.09			N/A	N/A

2032 Faactored Base + 5yrs, PM

Data Errors and Warnings

Severity	Area	Item	Description
Warning	Demand Set Relationship	D4 - 2027 + Development Flows, AM	Demand Set relationships are chained. This may slow down the file.
Warning	Vehicle Mix		HV% is zero for all movements / time segments. Vehicle Mix matrix should be completed whether working in PCUs or Vehs. If HV% at the junction is genuinely zero, please ignore this warning.
Warning	Queue variations	Analysis Options	Queue percentiles may be unreliable if the mean queue in any time segment is very low or very high.

Junction Network

Junctions

Junction	Name	Junction type	Arm A Direction	Arm B Direction	Arm C Direction	Use circulating lanes	Junction Delay (s)	Junction LOS
1	Development Access	T-Junction	Two-way	Two-way	Two-way		0.00	A

Junction Network

Driving side	Lighting	Network residual capacity (%)	First arm reaching threshold	Network delay (s)	Network LOS
Left	Normal/unknown	900		0.00	A

Traffic Demand

Demand Set Details

ID	Scenario name	Time Period name	Traffic profile type	Start time (HH:mm)	Finish time (HH:mm)	Time segment length (min)	Run automatically	Relationship type	Relationship
D14	2032 Faactored Base + 5yrs	PM	ONE HOUR	15:00	16:30	15	✓	Simple	D10*G2

Demand overview (Traffic)

Arm	Linked arm	Profile type	Use O-D data	Average Demand (Veh/hr)	Scaling Factor (%)
A		ONE HOUR	✓	543	100.000
B		ONE HOUR	✓	0	100.000
C		ONE HOUR	✓	888	100.000

Origin-Destination Data

Demand (Veh/hr)

	To			
	A	B	C	
From	A	0	0	543
	B	0	0	0
	C	888	0	0

Proportions

	To			
	A	B	C	
From	A	0.00	0.00	1.00
	B	0.33	0.33	0.33
	C	1.00	0.00	0.00

Vehicle Mix

HV data entry mode	PCU Factor for a HV (PCU)
HV Percentages	2.00

Heavy Vehicle %

	To			
	A	B	C	
From	A	0	0	0
	B	0	0	0
	C	0	0	0

Average PCU Per Veh

	To			
	A	B	C	
From	A	1.000	1.000	1.000
	B	1.000	1.000	1.000
	C	1.000	1.000	1.000

Detailed Demand Data

Demand for each time segment

Arm	Time Segment	Demand (Veh/hr)	Demand in PCU (PCU/hr)
A	15:00-15:15	408	408
	15:15-15:30	488	488
	15:30-15:45	597	597
	15:45-16:00	597	597
	16:00-16:15	488	488

	16:15-16:30	408	408
B	15:00-15:15	0	0
	15:15-15:30	0	0
	15:30-15:45	0	0
	15:45-16:00	0	0
	16:00-16:15	0	0
	16:15-16:30	0	0
C	15:00-15:15	669	669
	15:15-15:30	798	798
	15:30-15:45	978	978
	15:45-16:00	978	978
	16:00-16:15	798	798
	16:15-16:30	669	669

Results

Results Summary for whole modelled period

Stream	Max RFC	Max Delay (s)	Max Queue (Veh)	Max 95th percentile Queue (Veh)	Max LOS	Average Demand (Veh/hr)	Total Junction Arrivals (Veh)
B-AC	0.00	0.00	0.0	~1	A	0	0
C-AB	0.00	0.00	0.0	~1	A	0	0
C-A						815	1222
A-B						0	0
A-C						498	747

Main Results for each time segment

15:00 - 15:15

Stream	Total Demand (Veh/hr)	Junction Arrivals (Veh)	Capacity (Veh/hr)	RFC	Throughput (Veh/hr)	Start queue (Veh)	End queue (Veh)	Delay (s)	Unsignalised level of service
B-AC	0	0	428	0.000	0	0.0	0.0	0.000	A
C-AB	0	0	1136	0.000	0	0.0	0.0	0.000	A
C-A	669	167			669				
A-B	0	0			0				
A-C	408	102			408				

15:15 - 15:30

Stream	Total Demand (Veh/hr)	Junction Arrivals (Veh)	Capacity (Veh/hr)	RFC	Throughput (Veh/hr)	Start queue (Veh)	End queue (Veh)	Delay (s)	Unsignalised level of service
B-AC	0	0	396	0.000	0	0.0	0.0	0.000	A
C-AB	0	0	1100	0.000	0	0.0	0.0	0.000	A
C-A	798	200			798				
A-B	0	0			0				
A-C	488	122			488				

15:30 - 15:45

Stream	Total Demand (Veh/hr)	Junction Arrivals (Veh)	Capacity (Veh/hr)	RFC	Throughput (Veh/hr)	Start queue (Veh)	End queue (Veh)	Delay (s)	Unsignalised level of service
B-AC	0	0	349	0.000	0	0.0	0.0	0.000	A
C-AB	0	0	1050	0.000	0	0.0	0.0	0.000	A
C-A	978	244			978				
A-B	0	0			0				
A-C	597	149			597				

15:45 - 16:00

Stream	Total Demand (Veh/hr)	Junction Arrivals (Veh)	Capacity (Veh/hr)	RFC	Throughput (Veh/hr)	Start queue (Veh)	End queue (Veh)	Delay (s)	Unsignalised level of service
B-AC	0	0	349	0.000	0	0.0	0.0	0.000	A
C-AB	0	0	1050	0.000	0	0.0	0.0	0.000	A
C-A	978	244			978				
A-B	0	0			0				
A-C	597	149			597				

16:00 - 16:15

Stream	Total Demand (Veh/hr)	Junction Arrivals (Veh)	Capacity (Veh/hr)	RFC	Throughput (Veh/hr)	Start queue (Veh)	End queue (Veh)	Delay (s)	Unsignalised level of service
B-AC	0	0	396	0.000	0	0.0	0.0	0.000	A
C-AB	0	0	1100	0.000	0	0.0	0.0	0.000	A
C-A	798	200			798				
A-B	0	0			0				
A-C	488	122			488				

16:15 - 16:30

Stream	Total Demand (Veh/hr)	Junction Arrivals (Veh)	Capacity (Veh/hr)	RFC	Throughput (Veh/hr)	Start queue (Veh)	End queue (Veh)	Delay (s)	Unsignalised level of service
B-AC	0	0	428	0.000	0	0.0	0.0	0.000	A
C-AB	0	0	1136	0.000	0	0.0	0.0	0.000	A
C-A	669	167			669				
A-B	0	0			0				
A-C	408	102			408				

Queue Variation Results for each time segment

15:00 - 15:15

Stream	Mean (Veh)	Q05 (Veh)	Q50 (Veh)	Q90 (Veh)	Q95 (Veh)	Percentile message	Marker message	Probability of reaching or exceeding marker	Probability of exactly reaching marker
B-AC	0.00	0.00	0.00	0.00	0.00			N/A	N/A
C-AB	0.00	0.00	0.00	0.00	0.00			N/A	N/A

15:15 - 15:30

Stream	Mean (Veh)	Q05 (Veh)	Q50 (Veh)	Q90 (Veh)	Q95 (Veh)	Percentile message	Marker message	Probability of reaching or exceeding marker	Probability of exactly reaching marker
B-AC	0.00	0.00	0.00	0.00	0.00			N/A	N/A
C-AB	0.00	0.00	0.00	0.00	0.00			N/A	N/A

15:30 - 15:45

Stream	Mean (Veh)	Q05 (Veh)	Q50 (Veh)	Q90 (Veh)	Q95 (Veh)	Percentile message	Marker message	Probability of reaching or exceeding marker	Probability of exactly reaching marker
B-AC	0.00	0.00	0.00	0.00	0.00			N/A	N/A
C-AB	0.00	0.00	0.00	0.00	0.00			N/A	N/A

15:45 - 16:00

Stream	Mean (Veh)	Q05 (Veh)	Q50 (Veh)	Q90 (Veh)	Q95 (Veh)	Percentile message	Marker message	Probability of reaching or exceeding marker	Probability of exactly reaching marker
B-AC	0.00	0.00	0.00	0.00	0.00			N/A	N/A
C-AB	0.00	0.00	0.00	0.00	0.00			N/A	N/A

16:00 - 16:15

Stream	Mean (Veh)	Q05 (Veh)	Q50 (Veh)	Q90 (Veh)	Q95 (Veh)	Percentile message	Marker message	Probability of reaching or exceeding marker	Probability of exactly reaching marker
B-AC	0.00	0.00	0.00	0.00	0.00			N/A	N/A
C-AB	0.00	0.00	0.00	0.00	0.00			N/A	N/A

16:15 - 16:30

Stream	Mean (Veh)	Q05 (Veh)	Q50 (Veh)	Q90 (Veh)	Q95 (Veh)	Percentile message	Marker message	Probability of reaching or exceeding marker	Probability of exactly reaching marker
B-AC	0.00	0.00	0.00	0.00	0.00			N/A	N/A
C-AB	0.00	0.00	0.00	0.00	0.00			N/A	N/A

2032 Faactored Base + Dev Flows = +5yrs, PM

Data Errors and Warnings

Severity	Area	Item	Description
Warning	Demand Set Relationship	D4 - 2027 + Development Flows, AM	Demand Set relationships are chained. This may slow down the file.
Warning	Vehicle Mix		HV% is zero for all movements / time segments. Vehicle Mix matrix should be completed whether working in PCUs or Vehs. If HV% at the junction is genuinely zero, please ignore this warning.
Warning	Queue variations	Analysis Options	Queue percentiles may be unreliable if the mean queue in any time segment is very low or very high.

Junction Network

Junctions

Junction	Name	Junction type	Arm A Direction	Arm B Direction	Arm C Direction	Use circulating lanes	Junction Delay (s)	Junction LOS
1	Development Access	T-Junction	Two-way	Two-way	Two-way		0.87	A

Junction Network

Driving side	Lighting	Network residual capacity (%)	First arm reaching threshold	Network delay (s)	Network LOS
Left	Normal/unknown	38	Stream B-AC	0.87	A

Traffic Demand

Demand Set Details

ID	Scenario name	Time Period name	Traffic profile type	Start time (HH:mm)	Finish time (HH:mm)	Time segment length (min)	Run automatically	Relationship type	Relationship
D15	2032 Faactored Base + Dev Flows = +5yrs	PM	ONE HOUR	15:00	16:30	15	✓	Simple	D12+D14

Demand overview (Traffic)

Arm	Linked arm	Profile type	Use O-D data	Average Demand (Veh/hr)	Scaling Factor (%)
A		ONE HOUR	✓	605	100.000
B		ONE HOUR	✓	63	100.000
C		ONE HOUR	✓	950	100.000

Origin-Destination Data

Demand (Veh/hr)

		To		
		A	B	C
From	A	0	62	543
	B	32	0	31
	C	888	62	0

Proportions

		To		
		A	B	C
From	A	0.00	0.10	0.90
	B	0.51	0.00	0.49
	C	0.93	0.07	0.00

Vehicle Mix

HV data entry mode	PCU Factor for a HV (PCU)
HV Percentages	2.00

Heavy Vehicle %

		To		
		A	B	C
From	A	0	0	0
	B	0	0	0
	C	0	0	0

Average PCU Per Veh

		To		
		A	B	C
From	A	1.000	1.000	1.000
	B	1.000	1.000	1.000
	C	1.000	1.000	1.000

Detailed Demand Data

Demand for each time segment

Arm	Time Segment	Demand (Veh/hr)	Demand in PCU (PCU/hr)
A	15:00-15:15	455	455
	15:15-15:30	544	544
	15:30-15:45	666	666

	15:45-16:00	666	666
	16:00-16:15	544	544
	16:15-16:30	455	455
B	15:00-15:15	47	47
	15:15-15:30	57	57
	15:30-15:45	69	69
	15:45-16:00	69	69
	16:00-16:15	57	57
	16:15-16:30	47	47
C	15:00-15:15	715	715
	15:15-15:30	854	854
	15:30-15:45	1046	1046
	15:45-16:00	1046	1046
	16:00-16:15	854	854
	16:15-16:30	715	715

Results

Results Summary for whole modelled period

Stream	Max RFC	Max Delay (s)	Max Queue (Veh)	Max 95th percentile Queue (Veh)	Max LOS	Average Demand (Veh/hr)	Total Junction Arrivals (Veh)
B-AC	0.22	14.27	0.3	1.3	B	58	87
C-AB	0.13	8.15	0.2	0.5	A	57	85
C-A						815	1222
A-B						57	85
A-C						498	747

Main Results for each time segment

15:00 - 15:15

Stream	Total Demand (Veh/hr)	Junction Arrivals (Veh)	Capacity (Veh/hr)	RFC	Throughput (Veh/hr)	Start queue (Veh)	End queue (Veh)	Delay (s)	Unsignalised level of service
B-AC	47	12	411	0.116	47	0.0	0.1	9.886	A
C-AB	47	12	558	0.084	46	0.0	0.1	7.037	A
C-A	669	167			669				
A-B	47	12			47				
A-C	408	102			408				

15:15 - 15:30

Stream	Total Demand (Veh/hr)	Junction Arrivals (Veh)	Capacity (Veh/hr)	RFC	Throughput (Veh/hr)	Start queue (Veh)	End queue (Veh)	Delay (s)	Unsignalised level of service
B-AC	57	14	374	0.151	56	0.1	0.2	11.318	B
C-AB	56	14	537	0.104	56	0.1	0.1	7.470	A
C-A	798	200			798				
A-B	56	14			56				
A-C	488	122			488				

15:30 - 15:45

Stream	Total Demand (Veh/hr)	Junction Arrivals (Veh)	Capacity (Veh/hr)	RFC	Throughput (Veh/hr)	Start queue (Veh)	End queue (Veh)	Delay (s)	Unsignalised level of service
B-AC	69	17	322	0.216	69	0.2	0.3	14.231	B
C-AB	68	17	510	0.134	68	0.1	0.2	8.150	A
C-A	978	244			978				
A-B	68	17			68				
A-C	597	149			597				

15:45 - 16:00

Stream	Total Demand (Veh/hr)	Junction Arrivals (Veh)	Capacity (Veh/hr)	RFC	Throughput (Veh/hr)	Start queue (Veh)	End queue (Veh)	Delay (s)	Unsignalised level of service
B-AC	69	17	322	0.216	69	0.3	0.3	14.275	B
C-AB	68	17	510	0.134	68	0.2	0.2	8.154	A
C-A	978	244			978				
A-B	68	17			68				
A-C	597	149			597				

16:00 - 16:15

Stream	Total Demand (Veh/hr)	Junction Arrivals (Veh)	Capacity (Veh/hr)	RFC	Throughput (Veh/hr)	Start queue (Veh)	End queue (Veh)	Delay (s)	Unsignalised level of service
B-AC	57	14	374	0.151	57	0.3	0.2	11.360	B
C-AB	56	14	537	0.104	56	0.2	0.1	7.477	A
C-A	798	200			798				

A-B	56	14			56				
A-C	488	122			488				

16:15 - 16:30

Stream	Total Demand (Veh/hr)	Junction Arrivals (Veh)	Capacity (Veh/hr)	RFC	Throughput (Veh/hr)	Start queue (Veh)	End queue (Veh)	Delay (s)	Unsignalised level of service
B-AC	47	12	410	0.116	48	0.2	0.1	9.929	A
C-AB	47	12	558	0.084	47	0.1	0.1	7.051	A
C-A	669	167			669				
A-B	47	12			47				
A-C	408	102			408				

Queue Variation Results for each time segment**15:00 - 15:15**

Stream	Mean (Veh)	Q05 (Veh)	Q50 (Veh)	Q90 (Veh)	Q95 (Veh)	Percentile message	Marker message	Probability of reaching or exceeding marker	Probability of exactly reaching marker
B-AC	0.13	0.00	0.00	0.13	0.13			N/A	N/A
C-AB	0.09	0.00	0.00	0.09	0.09			N/A	N/A

15:15 - 15:30

Stream	Mean (Veh)	Q05 (Veh)	Q50 (Veh)	Q90 (Veh)	Q95 (Veh)	Percentile message	Marker message	Probability of reaching or exceeding marker	Probability of exactly reaching marker
B-AC	0.18	0.00	0.00	0.18	0.18			N/A	N/A
C-AB	0.11	0.00	0.00	0.11	0.11			N/A	N/A

15:30 - 15:45

Stream	Mean (Veh)	Q05 (Veh)	Q50 (Veh)	Q90 (Veh)	Q95 (Veh)	Percentile message	Marker message	Probability of reaching or exceeding marker	Probability of exactly reaching marker
B-AC	0.27	0.03	0.26	0.47	0.49			N/A	N/A
C-AB	0.15	0.03	0.26	0.46	0.49			N/A	N/A

15:45 - 16:00

Stream	Mean (Veh)	Q05 (Veh)	Q50 (Veh)	Q90 (Veh)	Q95 (Veh)	Percentile message	Marker message	Probability of reaching or exceeding marker	Probability of exactly reaching marker
B-AC	0.27	0.03	0.30	0.96	1.27			N/A	N/A
C-AB	0.15	0.03	0.25	0.45	0.48			N/A	N/A

16:00 - 16:15

Stream	Mean (Veh)	Q05 (Veh)	Q50 (Veh)	Q90 (Veh)	Q95 (Veh)	Percentile message	Marker message	Probability of reaching or exceeding marker	Probability of exactly reaching marker
B-AC	0.18	0.00	0.00	0.18	0.18			N/A	N/A
C-AB	0.12	0.00	0.00	0.12	0.12			N/A	N/A

16:15 - 16:30

Stream	Mean (Veh)	Q05 (Veh)	Q50 (Veh)	Q90 (Veh)	Q95 (Veh)	Percentile message	Marker message	Probability of reaching or exceeding marker	Probability of exactly reaching marker
B-AC	0.13	0.00	0.00	0.13	0.13			N/A	N/A
C-AB	0.09	0.00	0.00	0.09	0.09			N/A	N/A

2042 Faactored Base + 15yrs, PM

Data Errors and Warnings

Severity	Area	Item	Description
Warning	Demand Set Relationship	D4 - 2027 + Development Flows, AM	Demand Set relationships are chained. This may slow down the file.
Warning	Vehicle Mix		HV% is zero for all movements / time segments. Vehicle Mix matrix should be completed whether working in PCUs or Vehs. If HV% at the junction is genuinely zero, please ignore this warning.
Warning	Queue variations	Analysis Options	Queue percentiles may be unreliable if the mean queue in any time segment is very low or very high.

Junction Network

Junctions

Junction	Name	Junction type	Arm A Direction	Arm B Direction	Arm C Direction	Use circulating lanes	Junction Delay (s)	Junction LOS
1	Development Access	T-Junction	Two-way	Two-way	Two-way		0.00	A

Junction Network

Driving side	Lighting	Network residual capacity (%)	First arm reaching threshold	Network delay (s)	Network LOS
Left	Normal/unknown	900		0.00	A

Traffic Demand

Demand Set Details

ID	Scenario name	Time Period name	Traffic profile type	Start time (HH:mm)	Finish time (HH:mm)	Time segment length (min)	Run automatically	Relationship type	Relationship
D16	2042 Faactored Base + 15yrs	PM	ONE HOUR	15:00	16:30	15	✓	Simple	D10*G3

Demand overview (Traffic)

Arm	Linked arm	Profile type	Use O-D data	Average Demand (Veh/hr)	Scaling Factor (%)
A		ONE HOUR	✓	553	100.000
B		ONE HOUR	✓	0	100.000
C		ONE HOUR	✓	906	100.000

Origin-Destination Data

Demand (Veh/hr)

	To			
	A	B	C	
From	A	0	0	553
	B	0	0	0
	C	906	0	0

Proportions

	To			
	A	B	C	
From	A	0.00	0.00	1.00
	B	0.33	0.33	0.33
	C	1.00	0.00	0.00

Vehicle Mix

HV data entry mode	PCU Factor for a HV (PCU)
HV Percentages	2.00

Heavy Vehicle %

	To			
	A	B	C	
From	A	0	0	0
	B	0	0	0
	C	0	0	0

Average PCU Per Veh

	To			
	A	B	C	
From	A	1.000	1.000	1.000
	B	1.000	1.000	1.000
	C	1.000	1.000	1.000

Detailed Demand Data

Demand for each time segment

Arm	Time Segment	Demand (Veh/hr)	Demand in PCU (PCU/hr)
A	15:00-15:15	417	417
	15:15-15:30	497	497
	15:30-15:45	609	609
	15:45-16:00	609	609
	16:00-16:15	497	497

	16:15-16:30	417	417
B	15:00-15:15	0	0
	15:15-15:30	0	0
	15:30-15:45	0	0
	15:45-16:00	0	0
	16:00-16:15	0	0
	16:15-16:30	0	0
C	15:00-15:15	682	682
	15:15-15:30	814	814
	15:30-15:45	997	997
	15:45-16:00	997	997
	16:00-16:15	814	814
	16:15-16:30	682	682

Results

Results Summary for whole modelled period

Stream	Max RFC	Max Delay (s)	Max Queue (Veh)	Max 95th percentile Queue (Veh)	Max LOS	Average Demand (Veh/hr)	Total Junction Arrivals (Veh)
B-AC	0.00	0.00	0.0	~1	A	0	0
C-AB	0.00	0.00	0.0	~1	A	0	0
C-A						831	1247
A-B						0	0
A-C						508	762

Main Results for each time segment

15:00 - 15:15

Stream	Total Demand (Veh/hr)	Junction Arrivals (Veh)	Capacity (Veh/hr)	RFC	Throughput (Veh/hr)	Start queue (Veh)	End queue (Veh)	Delay (s)	Unsignalised level of service
B-AC	0	0	424	0.000	0	0.0	0.0	0.000	A
C-AB	0	0	1133	0.000	0	0.0	0.0	0.000	A
C-A	682	170			682				
A-B	0	0			0				
A-C	417	104			417				

15:15 - 15:30

Stream	Total Demand (Veh/hr)	Junction Arrivals (Veh)	Capacity (Veh/hr)	RFC	Throughput (Veh/hr)	Start queue (Veh)	End queue (Veh)	Delay (s)	Unsignalised level of service
B-AC	0	0	392	0.000	0	0.0	0.0	0.000	A
C-AB	0	0	1096	0.000	0	0.0	0.0	0.000	A
C-A	814	204			814				
A-B	0	0			0				
A-C	497	124			497				

15:30 - 15:45

Stream	Total Demand (Veh/hr)	Junction Arrivals (Veh)	Capacity (Veh/hr)	RFC	Throughput (Veh/hr)	Start queue (Veh)	End queue (Veh)	Delay (s)	Unsignalised level of service
B-AC	0	0	344	0.000	0	0.0	0.0	0.000	A
C-AB	0	0	1045	0.000	0	0.0	0.0	0.000	A
C-A	997	249			997				
A-B	0	0			0				
A-C	609	152			609				

15:45 - 16:00

Stream	Total Demand (Veh/hr)	Junction Arrivals (Veh)	Capacity (Veh/hr)	RFC	Throughput (Veh/hr)	Start queue (Veh)	End queue (Veh)	Delay (s)	Unsignalised level of service
B-AC	0	0	344	0.000	0	0.0	0.0	0.000	A
C-AB	0	0	1045	0.000	0	0.0	0.0	0.000	A
C-A	997	249			997				
A-B	0	0			0				
A-C	609	152			609				

16:00 - 16:15

Stream	Total Demand (Veh/hr)	Junction Arrivals (Veh)	Capacity (Veh/hr)	RFC	Throughput (Veh/hr)	Start queue (Veh)	End queue (Veh)	Delay (s)	Unsignalised level of service
B-AC	0	0	392	0.000	0	0.0	0.0	0.000	A
C-AB	0	0	1096	0.000	0	0.0	0.0	0.000	A
C-A	814	204			814				
A-B	0	0			0				
A-C	497	124			497				

16:15 - 16:30

Stream	Total Demand (Veh/hr)	Junction Arrivals (Veh)	Capacity (Veh/hr)	RFC	Throughput (Veh/hr)	Start queue (Veh)	End queue (Veh)	Delay (s)	Unsignalised level of service
B-AC	0	0	424	0.000	0	0.0	0.0	0.000	A
C-AB	0	0	1133	0.000	0	0.0	0.0	0.000	A
C-A	682	170			682				
A-B	0	0			0				
A-C	417	104			417				

Queue Variation Results for each time segment

15:00 - 15:15

Stream	Mean (Veh)	Q05 (Veh)	Q50 (Veh)	Q90 (Veh)	Q95 (Veh)	Percentile message	Marker message	Probability of reaching or exceeding marker	Probability of exactly reaching marker
B-AC	0.00	0.00	0.00	0.00	0.00			N/A	N/A
C-AB	0.00	0.00	0.00	0.00	0.00			N/A	N/A

15:15 - 15:30

Stream	Mean (Veh)	Q05 (Veh)	Q50 (Veh)	Q90 (Veh)	Q95 (Veh)	Percentile message	Marker message	Probability of reaching or exceeding marker	Probability of exactly reaching marker
B-AC	0.00	0.00	0.00	0.00	0.00			N/A	N/A
C-AB	0.00	0.00	0.00	0.00	0.00			N/A	N/A

15:30 - 15:45

Stream	Mean (Veh)	Q05 (Veh)	Q50 (Veh)	Q90 (Veh)	Q95 (Veh)	Percentile message	Marker message	Probability of reaching or exceeding marker	Probability of exactly reaching marker
B-AC	0.00	0.00	0.00	0.00	0.00			N/A	N/A
C-AB	0.00	0.00	0.00	0.00	0.00			N/A	N/A

15:45 - 16:00

Stream	Mean (Veh)	Q05 (Veh)	Q50 (Veh)	Q90 (Veh)	Q95 (Veh)	Percentile message	Marker message	Probability of reaching or exceeding marker	Probability of exactly reaching marker
B-AC	0.00	0.00	0.00	0.00	0.00			N/A	N/A
C-AB	0.00	0.00	0.00	0.00	0.00			N/A	N/A

16:00 - 16:15

Stream	Mean (Veh)	Q05 (Veh)	Q50 (Veh)	Q90 (Veh)	Q95 (Veh)	Percentile message	Marker message	Probability of reaching or exceeding marker	Probability of exactly reaching marker
B-AC	0.00	0.00	0.00	0.00	0.00			N/A	N/A
C-AB	0.00	0.00	0.00	0.00	0.00			N/A	N/A

16:15 - 16:30

Stream	Mean (Veh)	Q05 (Veh)	Q50 (Veh)	Q90 (Veh)	Q95 (Veh)	Percentile message	Marker message	Probability of reaching or exceeding marker	Probability of exactly reaching marker
B-AC	0.00	0.00	0.00	0.00	0.00			N/A	N/A
C-AB	0.00	0.00	0.00	0.00	0.00			N/A	N/A

2042 Faactored Base + 15yrs + Dev Flows, PM

Data Errors and Warnings

Severity	Area	Item	Description
Warning	Demand Set Relationship	D4 - 2027 + Development Flows, AM	Demand Set relationships are chained. This may slow down the file.
Warning	Vehicle Mix		HV% is zero for all movements / time segments. Vehicle Mix matrix should be completed whether working in PCUs or Vehs. If HV% at the junction is genuinely zero, please ignore this warning.
Warning	Queue variations	Analysis Options	Queue percentiles may be unreliable if the mean queue in any time segment is very low or very high.

Junction Network

Junctions

Junction	Name	Junction type	Arm A Direction	Arm B Direction	Arm C Direction	Use circulating lanes	Junction Delay (s)	Junction LOS
1	Development Access	T-Junction	Two-way	Two-way	Two-way		0.87	A

Junction Network

Driving side	Lighting	Network residual capacity (%)	First arm reaching threshold	Network delay (s)	Network LOS
Left	Normal/unknown	36	Stream B-AC	0.87	A

Traffic Demand

Demand Set Details

ID	Scenario name	Time Period name	Traffic profile type	Start time (HH:mm)	Finish time (HH:mm)	Time segment length (min)	Run automatically	Relationship type	Relationship
D17	2042 Faactored Base + 15yrs + Dev Flows	PM	ONE HOUR	15:00	16:30	15	✓	Simple	D12+D16

Demand overview (Traffic)

Arm	Linked arm	Profile type	Use O-D data	Average Demand (Veh/hr)	Scaling Factor (%)
A		ONE HOUR	✓	615	100.000
B		ONE HOUR	✓	63	100.000
C		ONE HOUR	✓	968	100.000

Origin-Destination Data

Demand (Veh/hr)

		To		
		A	B	C
From	A	0	62	553
	B	32	0	31
	C	906	62	0

Proportions

		To		
		A	B	C
From	A	0.00	0.10	0.90
	B	0.51	0.00	0.49
	C	0.94	0.06	0.00

Vehicle Mix

HV data entry mode	PCU Factor for a HV (PCU)
HV Percentages	2.00

Heavy Vehicle %

		To		
		A	B	C
From	A	0	0	0
	B	0	0	0
	C	0	0	0

Average PCU Per Veh

		To		
		A	B	C
From	A	1.000	1.000	1.000
	B	1.000	1.000	1.000
	C	1.000	1.000	1.000

Detailed Demand Data

Demand for each time segment

Arm	Time Segment	Demand (Veh/hr)	Demand in PCU (PCU/hr)
A	15:00-15:15	463	463
	15:15-15:30	553	553
	15:30-15:45	677	677

	15:45-16:00	677	677
	16:00-16:15	553	553
	16:15-16:30	463	463
B	15:00-15:15	47	47
	15:15-15:30	57	57
	15:30-15:45	69	69
	15:45-16:00	69	69
	16:00-16:15	57	57
	16:15-16:30	47	47
C	15:00-15:15	728	728
	15:15-15:30	870	870
	15:30-15:45	1065	1065
	15:45-16:00	1065	1065
	16:00-16:15	870	870
	16:15-16:30	728	728

Results

Results Summary for whole modelled period

Stream	Max RFC	Max Delay (s)	Max Queue (Veh)	Max 95th percentile Queue (Veh)	Max LOS	Average Demand (Veh/hr)	Total Junction Arrivals (Veh)
B-AC	0.22	14.59	0.3	1.3	B	58	87
C-AB	0.13	8.20	0.2	0.5	A	57	85
C-A						831	1246
A-B						57	85
A-C						508	762

Main Results for each time segment

15:00 - 15:15

Stream	Total Demand (Veh/hr)	Junction Arrivals (Veh)	Capacity (Veh/hr)	RFC	Throughput (Veh/hr)	Start queue (Veh)	End queue (Veh)	Delay (s)	Unsignalised level of service
B-AC	47	12	407	0.116	47	0.0	0.1	9.977	A
C-AB	47	12	556	0.084	46	0.0	0.1	7.063	A
C-A	682	170			682				
A-B	47	12			47				
A-C	417	104			417				

15:15 - 15:30

Stream	Total Demand (Veh/hr)	Junction Arrivals (Veh)	Capacity (Veh/hr)	RFC	Throughput (Veh/hr)	Start queue (Veh)	End queue (Veh)	Delay (s)	Unsignalised level of service
B-AC	57	14	370	0.153	56	0.1	0.2	11.466	B
C-AB	56	14	535	0.104	56	0.1	0.1	7.504	A
C-A	814	204			814				
A-B	56	14			56				
A-C	497	124			497				

15:30 - 15:45

Stream	Total Demand (Veh/hr)	Junction Arrivals (Veh)	Capacity (Veh/hr)	RFC	Throughput (Veh/hr)	Start queue (Veh)	End queue (Veh)	Delay (s)	Unsignalised level of service
B-AC	69	17	316	0.219	69	0.2	0.3	14.538	B
C-AB	68	17	507	0.135	68	0.1	0.2	8.199	A
C-A	997	249			997				
A-B	68	17			68				
A-C	609	152			609				

15:45 - 16:00

Stream	Total Demand (Veh/hr)	Junction Arrivals (Veh)	Capacity (Veh/hr)	RFC	Throughput (Veh/hr)	Start queue (Veh)	End queue (Veh)	Delay (s)	Unsignalised level of service
B-AC	69	17	316	0.219	69	0.3	0.3	14.586	B
C-AB	68	17	507	0.135	68	0.2	0.2	8.204	A
C-A	997	249			997				
A-B	68	17			68				
A-C	609	152			609				

16:00 - 16:15

Stream	Total Demand (Veh/hr)	Junction Arrivals (Veh)	Capacity (Veh/hr)	RFC	Throughput (Veh/hr)	Start queue (Veh)	End queue (Veh)	Delay (s)	Unsignalised level of service
B-AC	57	14	370	0.153	57	0.3	0.2	11.512	B
C-AB	56	14	535	0.104	56	0.2	0.1	7.514	A
C-A	814	204			814				

A-B	56	14			56				
A-C	497	124			497				

16:15 - 16:30

Stream	Total Demand (Veh/hr)	Junction Arrivals (Veh)	Capacity (Veh/hr)	RFC	Throughput (Veh/hr)	Start queue (Veh)	End queue (Veh)	Delay (s)	Unsignalised level of service
B-AC	47	12	407	0.117	48	0.2	0.1	10.018	B
C-AB	47	12	556	0.084	47	0.1	0.1	7.074	A
C-A	682	170			682				
A-B	47	12			47				
A-C	417	104			417				

Queue Variation Results for each time segment**15:00 - 15:15**

Stream	Mean (Veh)	Q05 (Veh)	Q50 (Veh)	Q90 (Veh)	Q95 (Veh)	Percentile message	Marker message	Probability of reaching or exceeding marker	Probability of exactly reaching marker
B-AC	0.13	0.00	0.00	0.13	0.13			N/A	N/A
C-AB	0.09	0.00	0.00	0.09	0.09			N/A	N/A

15:15 - 15:30

Stream	Mean (Veh)	Q05 (Veh)	Q50 (Veh)	Q90 (Veh)	Q95 (Veh)	Percentile message	Marker message	Probability of reaching or exceeding marker	Probability of exactly reaching marker
B-AC	0.18	0.00	0.00	0.18	0.18			N/A	N/A
C-AB	0.12	0.00	0.00	0.12	0.12			N/A	N/A

15:30 - 15:45

Stream	Mean (Veh)	Q05 (Veh)	Q50 (Veh)	Q90 (Veh)	Q95 (Veh)	Percentile message	Marker message	Probability of reaching or exceeding marker	Probability of exactly reaching marker
B-AC	0.28	0.03	0.26	0.47	0.49			N/A	N/A
C-AB	0.15	0.03	0.26	0.46	0.49			N/A	N/A

15:45 - 16:00

Stream	Mean (Veh)	Q05 (Veh)	Q50 (Veh)	Q90 (Veh)	Q95 (Veh)	Percentile message	Marker message	Probability of reaching or exceeding marker	Probability of exactly reaching marker
B-AC	0.28	0.03	0.30	0.98	1.29			N/A	N/A
C-AB	0.15	0.03	0.25	0.45	0.48			N/A	N/A

16:00 - 16:15

Stream	Mean (Veh)	Q05 (Veh)	Q50 (Veh)	Q90 (Veh)	Q95 (Veh)	Percentile message	Marker message	Probability of reaching or exceeding marker	Probability of exactly reaching marker
B-AC	0.18	0.00	0.00	0.18	0.18			N/A	N/A
C-AB	0.12	0.00	0.00	0.12	0.12			N/A	N/A

16:15 - 16:30

Stream	Mean (Veh)	Q05 (Veh)	Q50 (Veh)	Q90 (Veh)	Q95 (Veh)	Percentile message	Marker message	Probability of reaching or exceeding marker	Probability of exactly reaching marker
B-AC	0.13	0.00	0.00	0.13	0.13			N/A	N/A
C-AB	0.09	0.00	0.00	0.09	0.09			N/A	N/A

2042 Faactored Base + 15yrs + Dev Flows x 2, PM

Data Errors and Warnings

Severity	Area	Item	Description
Warning	Demand Set Relationship	D4 - 2027 + Development Flows, AM	Demand Set relationships are chained. This may slow down the file.
Warning	Vehicle Mix		HV% is zero for all movements / time segments. Vehicle Mix matrix should be completed whether working in PCUs or Vehs. If HV% at the junction is genuinely zero, please ignore this warning.
Warning	Queue variations	Analysis Options	Queue percentiles may be unreliable if the mean queue in any time segment is very low or very high.

Junction Network

Junctions

Junction	Name	Junction type	Arm A Direction	Arm B Direction	Arm C Direction	Use circulating lanes	Junction Delay (s)	Junction LOS
1	Development Access	T-Junction	Two-way	Two-way	Two-way		2.33	A

Junction Network

Driving side	Lighting	Network residual capacity (%)	First arm reaching threshold	Network delay (s)	Network LOS
Left	Normal/unknown	10	Stream B-AC	2.33	A

Traffic Demand

Demand Set Details

ID	Scenario name	Time Period name	Traffic profile type	Start time (HH:mm)	Finish time (HH:mm)	Time segment length (min)	Run automatically	Relationship type	Relationship
D18	2042 Faactored Base + 15yrs + Dev Flows x 2	PM	ONE HOUR	15:00	16:30	15	✓	Simple	(D12*2)+D16

Demand overview (Traffic)

Arm	Linked arm	Profile type	Use O-D data	Average Demand (Veh/hr)	Scaling Factor (%)
A		ONE HOUR	✓	677	100.000
B		ONE HOUR	✓	126	100.000
C		ONE HOUR	✓	1030	100.000

Origin-Destination Data

Demand (Veh/hr)

		To		
		A	B	C
From	A	0	124	553
	B	64	0	62
	C	906	124	0

Proportions

		To		
		A	B	C
From	A	0.00	0.18	0.82
	B	0.51	0.00	0.49
	C	0.88	0.12	0.00

Vehicle Mix

HV data entry mode	PCU Factor for a HV (PCU)
HV Percentages	2.00

Heavy Vehicle %

		To		
		A	B	C
From	A	0	0	0
	B	0	0	0
	C	0	0	0

Average PCU Per Veh

		To		
		A	B	C
From	A	1.000	1.000	1.000
	B	1.000	1.000	1.000
	C	1.000	1.000	1.000

Detailed Demand Data

Demand for each time segment

Arm	Time Segment	Demand (Veh/hr)	Demand in PCU (PCU/hr)
A	15:00-15:15	510	510
	15:15-15:30	609	609
	15:30-15:45	746	746

	15:45-16:00	746	746
	16:00-16:15	609	609
	16:15-16:30	510	510
B	15:00-15:15	95	95
	15:15-15:30	113	113
	15:30-15:45	139	139
	15:45-16:00	139	139
	16:00-16:15	113	113
	16:15-16:30	95	95
C	15:00-15:15	775	775
	15:15-15:30	926	926
	15:30-15:45	1134	1134
	15:45-16:00	1134	1134
	16:00-16:15	926	926
	16:15-16:30	775	775

Results

Results Summary for whole modelled period

Stream	Max RFC	Max Delay (s)	Max Queue (Veh)	Max 95th percentile Queue (Veh)	Max LOS	Average Demand (Veh/hr)	Total Junction Arrivals (Veh)
B-AC	0.48	23.98	0.9	4.4	C	116	173
C-AB	0.28	10.03	0.4	1.5	B	114	172
C-A						830	1245
A-B						114	171
A-C						508	762

Main Results for each time segment

15:00 - 15:15

Stream	Total Demand (Veh/hr)	Junction Arrivals (Veh)	Capacity (Veh/hr)	RFC	Throughput (Veh/hr)	Start queue (Veh)	End queue (Veh)	Delay (s)	Unsignalised level of service
B-AC	95	24	391	0.242	94	0.0	0.3	12.046	B
C-AB	93	23	546	0.171	93	0.0	0.2	7.933	A
C-A	682	170			682				
A-B	93	23			93				
A-C	417	104			417				

15:15 - 15:30

Stream	Total Demand (Veh/hr)	Junction Arrivals (Veh)	Capacity (Veh/hr)	RFC	Throughput (Veh/hr)	Start queue (Veh)	End queue (Veh)	Delay (s)	Unsignalised level of service
B-AC	113	28	350	0.324	113	0.3	0.5	15.142	C
C-AB	112	28	524	0.213	112	0.2	0.3	8.721	A
C-A	814	203			814				
A-B	111	28			111				
A-C	497	124			497				

15:30 - 15:45

Stream	Total Demand (Veh/hr)	Junction Arrivals (Veh)	Capacity (Veh/hr)	RFC	Throughput (Veh/hr)	Start queue (Veh)	End queue (Veh)	Delay (s)	Unsignalised level of service
B-AC	139	35	289	0.481	137	0.5	0.9	23.483	C
C-AB	138	35	497	0.278	138	0.3	0.4	10.006	B
C-A	995	249			995				
A-B	137	34			137				
A-C	609	152			609				

15:45 - 16:00

Stream	Total Demand (Veh/hr)	Junction Arrivals (Veh)	Capacity (Veh/hr)	RFC	Throughput (Veh/hr)	Start queue (Veh)	End queue (Veh)	Delay (s)	Unsignalised level of service
B-AC	139	35	289	0.481	139	0.9	0.9	23.978	C
C-AB	138	35	497	0.278	138	0.4	0.4	10.029	B
C-A	995	249			995				
A-B	137	34			137				
A-C	609	152			609				

16:00 - 16:15

Stream	Total Demand (Veh/hr)	Junction Arrivals (Veh)	Capacity (Veh/hr)	RFC	Throughput (Veh/hr)	Start queue (Veh)	End queue (Veh)	Delay (s)	Unsignalised level of service
B-AC	113	28	350	0.324	115	0.9	0.5	15.445	C
C-AB	112	28	524	0.213	112	0.4	0.3	8.752	A
C-A	814	203			814				

A-B	111	28			111				
A-C	497	124			497				

16:15 - 16:30

Stream	Total Demand (Veh/hr)	Junction Arrivals (Veh)	Capacity (Veh/hr)	RFC	Throughput (Veh/hr)	Start queue (Veh)	End queue (Veh)	Delay (s)	Unsignalised level of service
B-AC	95	24	391	0.243	96	0.5	0.3	12.214	B
C-AB	93	23	546	0.171	94	0.3	0.2	7.971	A
C-A	682	170			682				
A-B	93	23			93				
A-C	417	104			417				

Queue Variation Results for each time segment**15:00 - 15:15**

Stream	Mean (Veh)	Q05 (Veh)	Q50 (Veh)	Q90 (Veh)	Q95 (Veh)	Percentile message	Marker message	Probability of reaching or exceeding marker	Probability of exactly reaching marker
B-AC	0.31	0.00	0.00	0.31	0.31			N/A	N/A
C-AB	0.20	0.00	0.00	0.20	0.20			N/A	N/A

15:15 - 15:30

Stream	Mean (Veh)	Q05 (Veh)	Q50 (Veh)	Q90 (Veh)	Q95 (Veh)	Percentile message	Marker message	Probability of reaching or exceeding marker	Probability of exactly reaching marker
B-AC	0.47	0.00	0.00	0.47	0.47			N/A	N/A
C-AB	0.27	0.00	0.00	0.27	0.27			N/A	N/A

15:30 - 15:45

Stream	Mean (Veh)	Q05 (Veh)	Q50 (Veh)	Q90 (Veh)	Q95 (Veh)	Percentile message	Marker message	Probability of reaching or exceeding marker	Probability of exactly reaching marker
B-AC	0.88	0.03	0.27	0.88	1.54			N/A	N/A
C-AB	0.38	0.03	0.26	0.46	0.49			N/A	N/A

15:45 - 16:00

Stream	Mean (Veh)	Q05 (Veh)	Q50 (Veh)	Q90 (Veh)	Q95 (Veh)	Percentile message	Marker message	Probability of reaching or exceeding marker	Probability of exactly reaching marker
B-AC	0.90	0.03	0.30	1.34	4.41			N/A	N/A
C-AB	0.39	0.03	0.31	1.27	1.49			N/A	N/A

16:00 - 16:15

Stream	Mean (Veh)	Q05 (Veh)	Q50 (Veh)	Q90 (Veh)	Q95 (Veh)	Percentile message	Marker message	Probability of reaching or exceeding marker	Probability of exactly reaching marker
B-AC	0.49	0.04	0.43	1.27	1.39			N/A	N/A
C-AB	0.28	0.00	0.00	0.28	0.28			N/A	N/A

16:15 - 16:30

Stream	Mean (Veh)	Q05 (Veh)	Q50 (Veh)	Q90 (Veh)	Q95 (Veh)	Percentile message	Marker message	Probability of reaching or exceeding marker	Probability of exactly reaching marker
B-AC	0.33	0.03	0.31	0.97	1.24			N/A	N/A
C-AB	0.21	0.00	0.00	0.21	0.21			N/A	N/A

Appendix D – Flow Diagrams

2023 Surveyed Flows

HoyDorman

AM FLOW DIAGRAMS (ODD NUMBERS)

FD_001 = 2023 AM BASE (08:15 - 09:15) = SURVEYED TRAFFIC

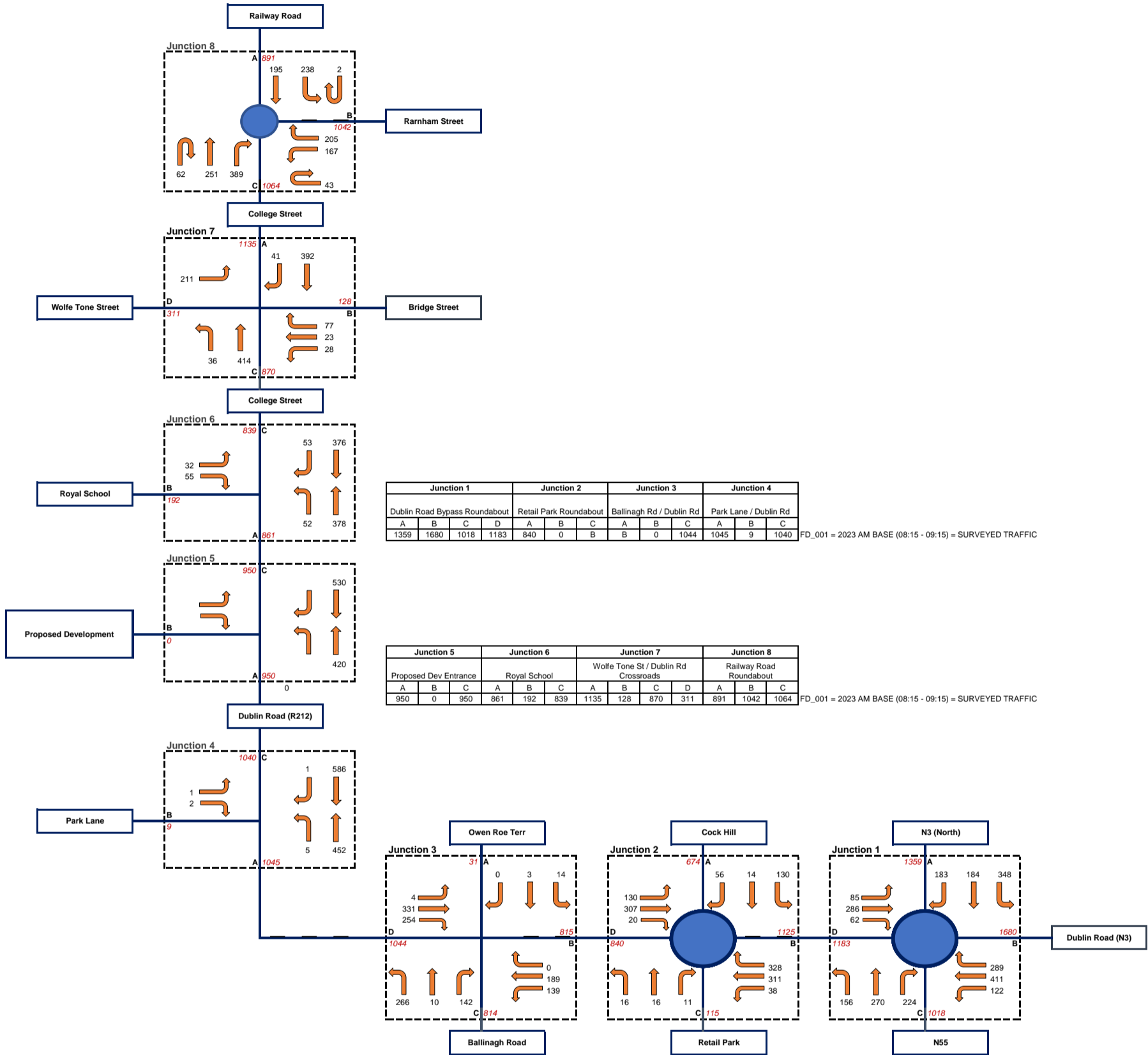

HoyDorman

PM FLOW DIAGRAMS (ODD NUMBERS)

FD_002 = 2023 PM PEAK BASE (17:00 - 18:00) = SURVEYED TRAFFIC

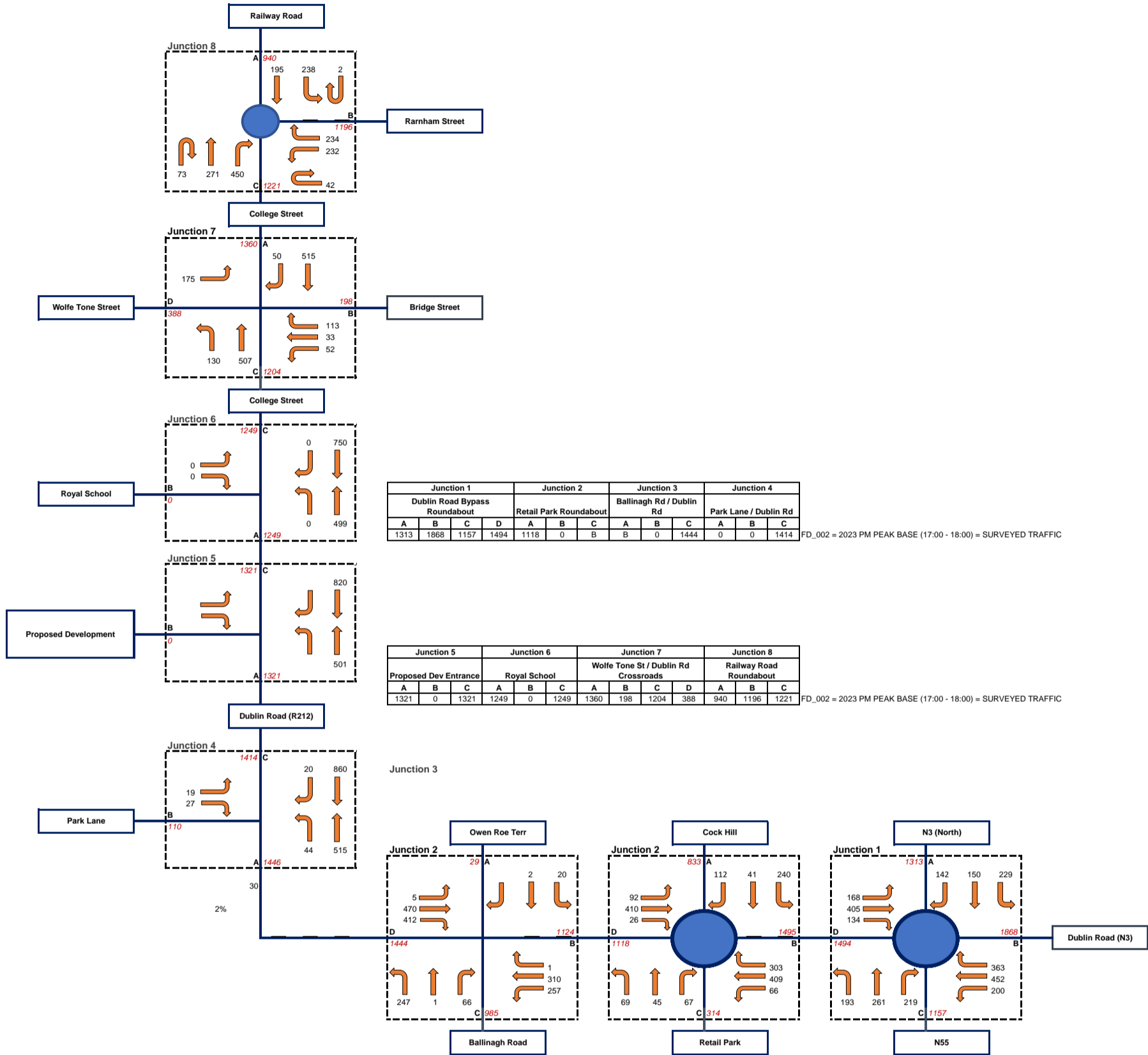

Junction 1 Dublin Road Bypass Roundabout				Junction 2 Retail Park Roundabout			Junction 3 Ballinagh Rd / Dublin Rd			Junction 4 Park Lane / Dublin Rd		
A	B	C	D	A	B	C	A	B	C	A	B	C
1313	1868	1157	1494	1118	0	B	B	0	1444	0	0	1414

FD_002 = 2023 PM PEAK BASE (17:00 - 18:00) = SURVEYED TRAFFIC

Junction 5 Proposed Dev Entrance			Junction 6 Royal School			Junction 7 Wolfe Tone St / Dublin Rd Crossroads				Junction 8 Railway Road Roundabout		
A	B	C	A	B	C	A	B	C	D	A	B	C
1321	0	1321	1249	0	1249	1360	198	1204	388	940	1196	1221

FD_002 = 2023 PM PEAK BASE (17:00 - 18:00) = SURVEYED TRAFFIC

All External Flows

HoyDorman

AM FLOW DIAGRAMS (ODD NUMBERS)

FD_001 = 2023 AM Peak Base (08:15 - 09:15) = Surveyed Traffic

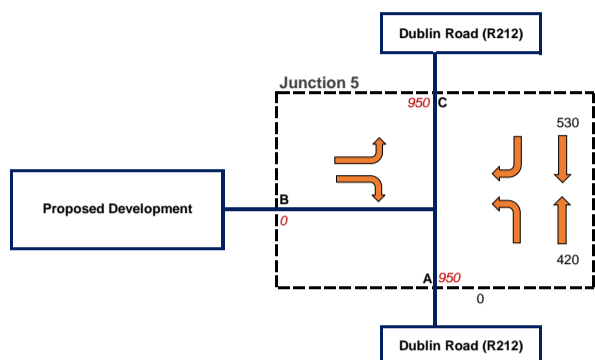

Junction 5		
Proposed Dev Entrance		
A	B	C
950	0	950

FD_001 = 2023 AM Peak Base (08:15 - 09:15) = Surveyed Traffic

PM FLOW DIAGRAMS (ODD NUMBERS)

FD_002 = 2023 PM Peak Base (17:00 - 18:00) = Surveyed Traffic

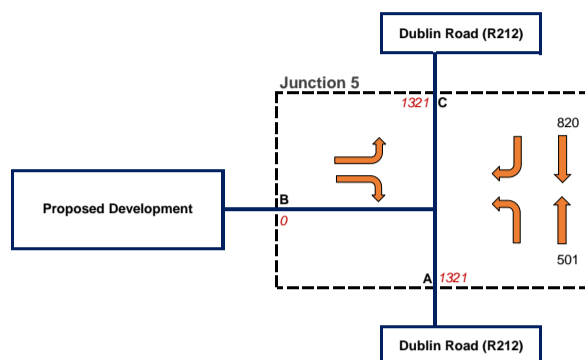

Junction 5		
Proposed Dev Entrance		
A	B	C
1321	0	1321

FD_002 = 2023 PM Peak Base (17:00 - 18:00) = Surveyed Traffic

FD_003 = 2027 Opening Year, AM

Factor 1.049

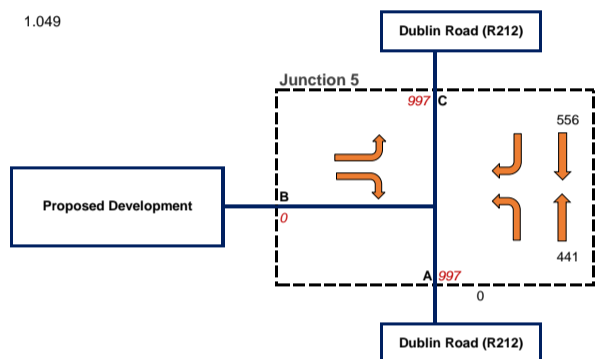

Junction 5		
Proposed Dev Entrance		
A	B	C
997	0	997

FD_001 = 2023 AM Peak Base (08:15 - 09:15) = Surveyed Traffic
FD_003 = 2027 Opening Year, AM

FD_004 = 2027 Opening Year, PM

Factor 1.049

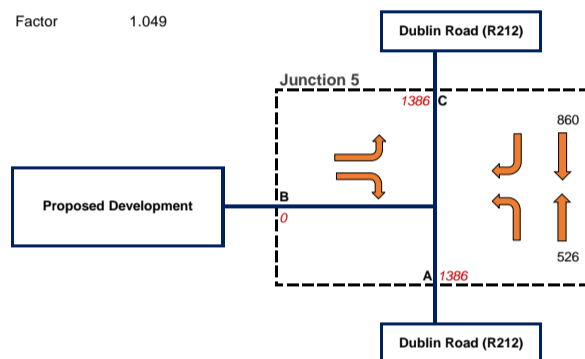

Junction 5		
Proposed Dev Entrance		
A	B	C
1386	0	1386

FD_002 = 2023 PM Peak Base (17:00 - 18:00) = Surveyed Traffic
FD_004 = 2027 Opening Year, PM

FD_005 = Development Flows, AM

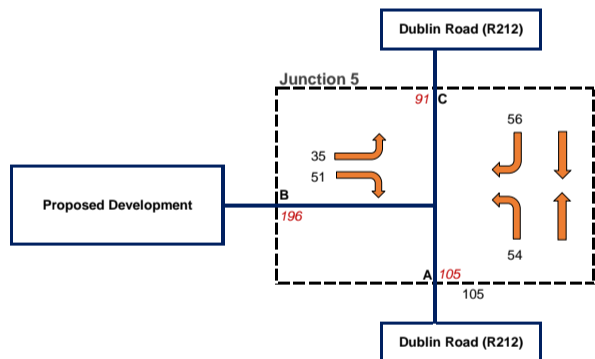

Junction 5		
Proposed Dev Entrance		
A	B	C
105	196	91

FD_001 = 2023 AM Peak Base (08:15 - 09:15) = Surveyed Traffic
FD_003 = 2027 Opening Year, AM
FD_005 = Development Flows, AM

FD_006 = Development Flows, PM

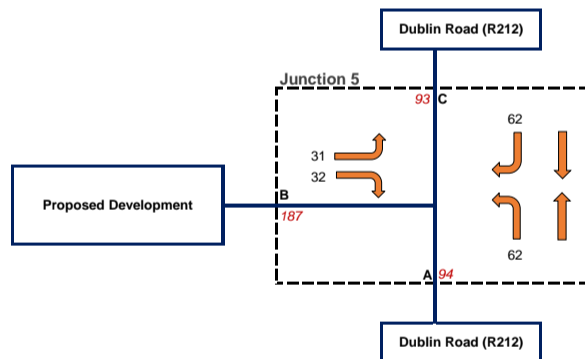

Junction 5		
Proposed Dev Entrance		
A	B	C
94	187	93

FD_002 = 2023 PM Peak Base (17:00 - 18:00) = Surveyed Traffic
FD_004 = 2027 Opening Year, PM
FD_006 = Development Flows, PM

FD_007 = 2027 + Development Flows, AM

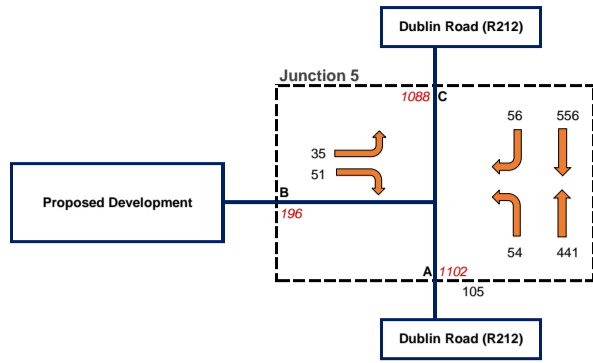

Junction 5		
Proposed Dev Entrance		
A	B	C
950	0	950
997	0	997
105	196	91
1102	196	1088
10%	100%	8%

FD_001 = 2023 AM Peak Base (08:15 - 09:15) = Surveyed Traffic
 FD_003 = 2027 Opening Year, AM
 FD_005 = Development Flows, AM
 FD_007 = 2027 + Development Flows, AM
 % Impact on Each Arm

FD_008 = 2027 + Development Flows, PM

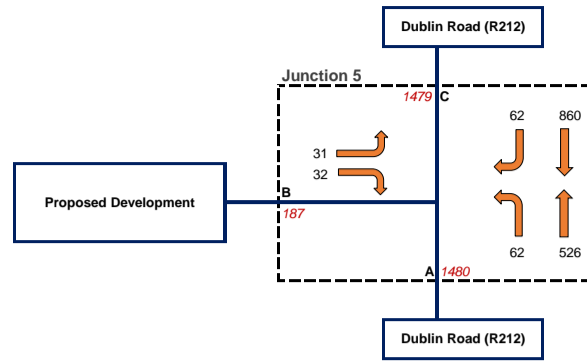

Junction 5		
Proposed Dev Entrance		
A	B	C
1321	0	1321
1386	0	1386
94	187	93
1480	187	1479
6%	100%	6%

FD_002 = 2023 PM Peak Base (17:00 - 18:00) = Surveyed Traffic
 FD_004 = 2027 Opening Year, PM
 FD_006 = Development Flows, PM
 FD_008 = 2027 + Development Flows, PM
 % Impact on Each Arm

FD_009 = 2032 Factored Base + Dev Flows = +5yrs, AM

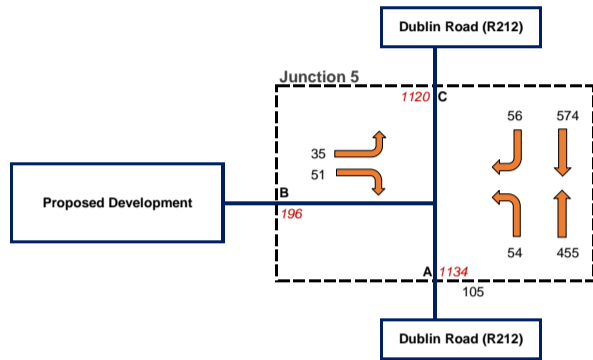

Junction 5		
Proposed Dev Entrance		
A	B	C
950	0	950
997	0	997
105	196	91
1102	196	1088
10%	100%	8%
1134	196	1120

FD_001 = 2023 AM Peak Base (08:15 - 09:15) = Surveyed Traffic
 FD_003 = 2027 Opening Year, AM
 FD_005 = Development Flows, AM
 FD_007 = 2027 + Development Flows, AM
 % Impact on Each Arm
 FD_009 = 2032 Factored Base + Dev Flows = +5yrs, AM

FD_010 = 2032 Factored Base + Dev Flows = +5yrs, PM

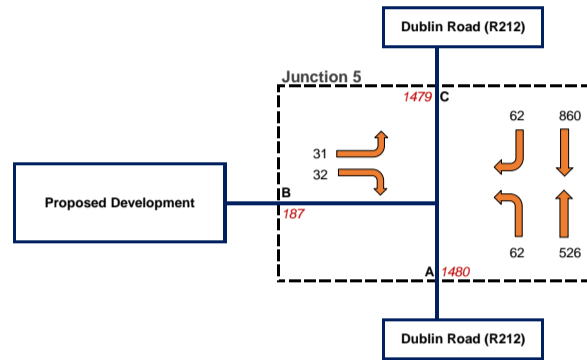

Junction 5		
Proposed Dev Entrance		
A	B	C
1321	0	1321
1386	0	1386
94	187	93
1480	187	1479
6%	100%	6%
1480	187	1479

FD_002 = 2023 PM Peak Base (17:00 - 18:00) = Surveyed Traffic
 FD_004 = 2027 Opening Year, PM
 FD_006 = Development Flows, PM
 FD_008 = 2027 + Development Flows, PM
 % Impact on Each Arm
 FD_010 = 2032 Factored Base + Dev Flows = +5yrs, PM

FD_011 = 2042 Factored Base + 15yrs + Dev Flows, AM

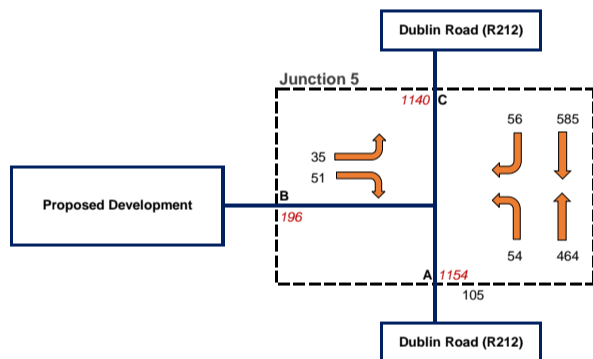

Junction 5		
Proposed Dev Entrance		
A	B	C
950	0	950
997	0	997
105	196	91
1102	196	1088
10%	100%	8%
1134	196	1120
1154	196	1140

FD_001 = 2023 AM Peak Base (08:15 - 09:15) = Surveyed Traffic
 FD_003 = 2027 Opening Year, AM
 FD_005 = Development Flows, AM
 FD_007 = 2027 + Development Flows, AM
 % Impact on Each Arm
 FD_009 = 2032 Factored Base + Dev Flows = +5yrs, AM
 FD_011 = 2042 Factored Base + 15yrs + Dev Flows, AM

FD_012 = 2042 Factored Base + 15yrs + Dev Flows, PM

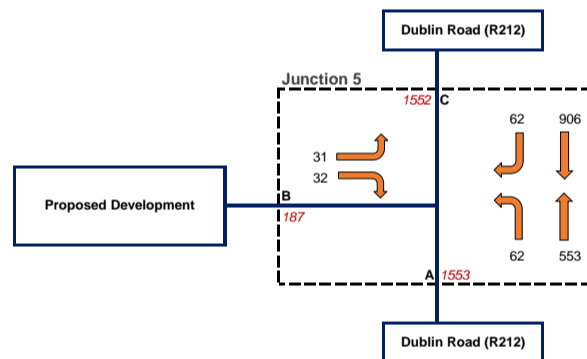

Junction 5		
Proposed Dev Entrance		
A	B	C
1321	0	1321
1386	0	1386
94	187	93
1480	187	1479
6%	100%	6%
1480	187	1479
1553	187	1552

FD_002 = 2023 PM Peak Base (17:00 - 18:00) = Surveyed Traffic
 FD_004 = 2027 Opening Year, PM
 FD_006 = Development Flows, PM
 FD_008 = 2027 + Development Flows, PM
 % Impact on Each Arm
 FD_010 = 2032 Factored Base + Dev Flows = +5yrs, PM
 FD_012 = 2042 Factored Base + 15yrs + Dev Flows, PM

Scheme only Flows

HoyDorman

AM FLOW DIAGRAMS (ODD NUMBERS)

FD_001 = 2023 AM Peak Base (08:15 - 09:15) = Surveyed Traffic

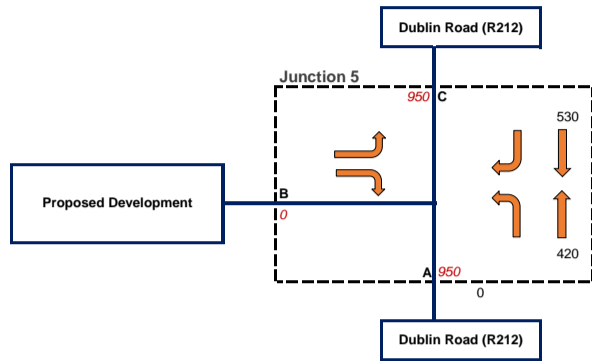

Junction 5		
Proposed Dev Entrance		
A	B	C
950	0	950

FD_001 = 2023 AM Peak Base (08:15 - 09:15) = Surveyed Traffic

PM FLOW DIAGRAMS (ODD NUMBERS)

FD_002 = 2023 PM Peak Base (17:00 - 18:00) = Surveyed Traffic

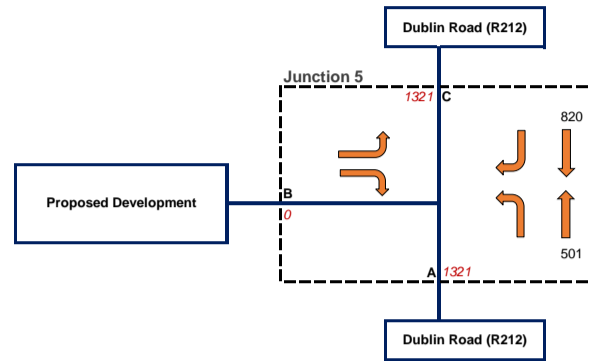

Junction 5		
Proposed Dev Entrance		
A	B	C
1321	0	1321

FD_002 = 2023 PM Peak Base (17:00 - 18:00) = Surveyed Traffic

FD_003 = 2027 Opening Year, AM

Factor 1.049

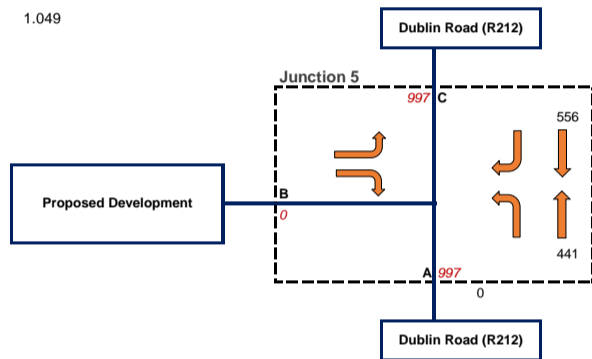

Junction 5		
Proposed Dev Entrance		
A	B	C
950	0	950
997	0	997

FD_001 = 2023 AM Peak Base (08:15 - 09:15) = Surveyed Traffic
FD_003 = 2027 Opening Year, AM

FD_004 = 2027 Opening Year, PM

Factor 1.049

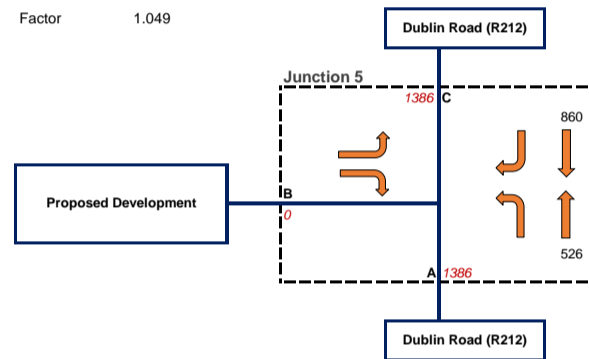

Junction 5		
Proposed Dev Entrance		
A	B	C
1321	0	1321
1386	0	1386

FD_002 = 2023 PM Peak Base (17:00 - 18:00) = Surveyed Traffic
FD_004 = 2027 Opening Year, PM

FD_005 = Development Flows, AM

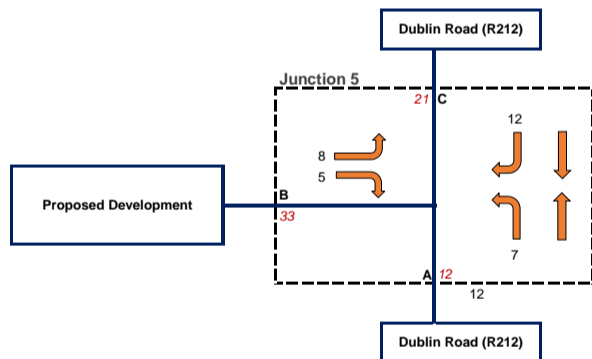

Junction 5		
Proposed Dev Entrance		
A	B	C
950	0	950
997	0	997
12	33	21

FD_001 = 2023 AM Peak Base (08:15 - 09:15) = Surveyed Traffic
FD_003 = 2027 Opening Year, AM
FD_005 = Development Flows, AM

FD_006 = Development Flows, PM

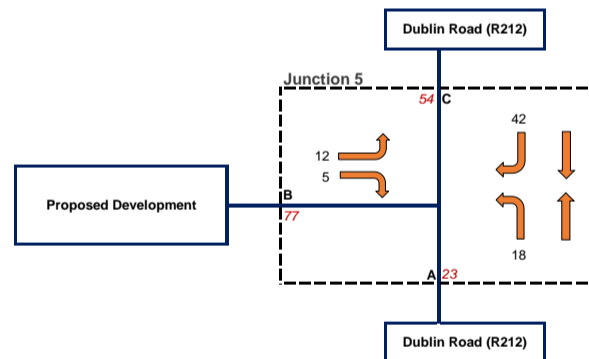

Junction 5		
Proposed Dev Entrance		
A	B	C
1321	0	1321
1386	0	1386
23	77	54

FD_002 = 2023 PM Peak Base (17:00 - 18:00) = Surveyed Traffic
FD_004 = 2027 Opening Year, PM
FD_006 = Development Flows, PM

FD_007 = 2027 + Development Flows, AM

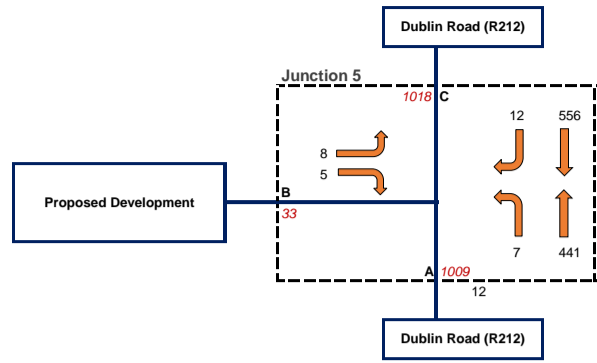

Junction 5		
Proposed Dev Entrance		
A	B	C
950	0	950
997	0	997
12	33	21
1009	33	1018
1%	100%	2%

FD_001 = 2023 AM Peak Base (08:15 - 09:15) = Surveyed Traffic
 FD_003 = 2027 Opening Year, AM
 FD_005 = Development Flows, AM
 FD_007 = 2027 + Development Flows, AM
 % Impact on Each Arm

FD_008 = 2027 + Development Flows, PM

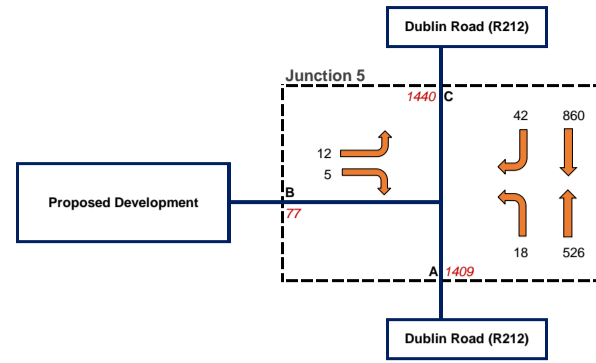

Junction 5		
Proposed Dev Entrance		
A	B	C
1321	0	1321
1386	0	1386
23	77	54
1409	77	1440
2%	100%	4%

FD_002 = 2023 PM Peak Base (17:00 - 18:00) = Surveyed Traffic
 FD_004 = 2027 Opening Year, PM
 FD_006 = Development Flows, PM
 FD_008 = 2027 + Development Flows, PM
 % Impact on Each Arm

FD_009 = 2032 Factored Base + Dev Flows = +5yrs, AM

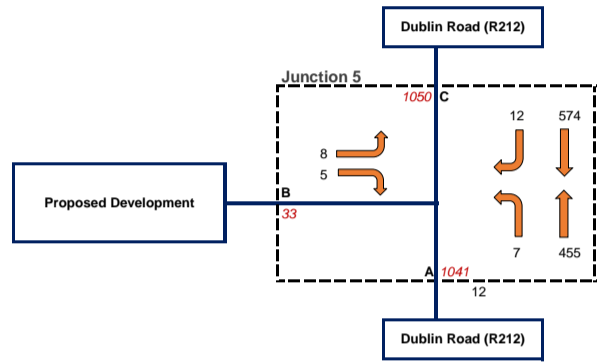

Junction 5		
Proposed Dev Entrance		
A	B	C
950	0	950
997	0	997
12	33	21
1009	33	1018
1%	100%	2%
1041	33	1050

FD_001 = 2023 AM Peak Base (08:15 - 09:15) = Surveyed Traffic
 FD_003 = 2027 Opening Year, AM
 FD_005 = Development Flows, AM
 FD_007 = 2027 + Development Flows, AM
 % Impact on Each Arm
 FD_009 = 2032 Factored Base + Dev Flows = +5yrs, AM

FD_010 = 2032 Factored Base + Dev Flows = +5yrs, PM

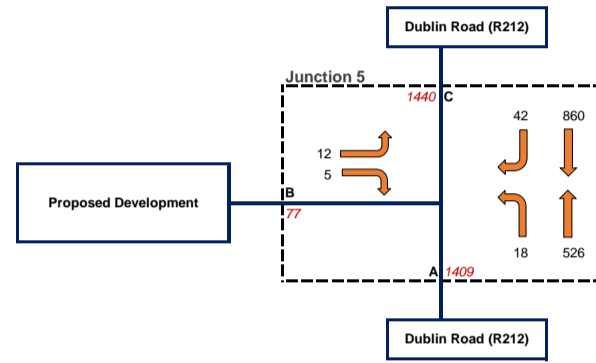

Junction 5		
Proposed Dev Entrance		
A	B	C
1321	0	1321
1386	0	1386
23	77	54
1409	77	1440
2%	100%	4%
1409	77	1440

FD_002 = 2023 PM Peak Base (17:00 - 18:00) = Surveyed Traffic
 FD_004 = 2027 Opening Year, PM
 FD_006 = Development Flows, PM
 FD_008 = 2027 + Development Flows, PM
 % Impact on Each Arm
 FD_010 = 2032 Factored Base + Dev Flows = +5yrs, PM

FD_011 = 2042 Factored Base + 15yrs + Dev Flows, AM

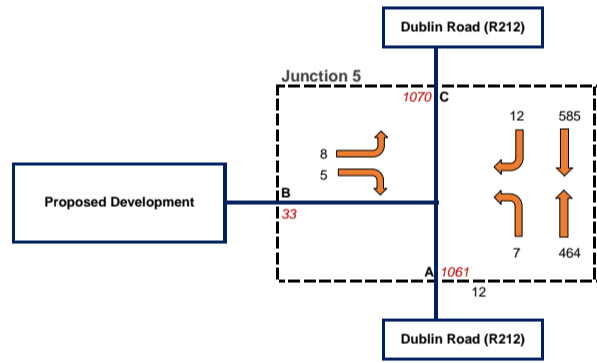

Junction 5		
Proposed Dev Entrance		
A	B	C
950	0	950
997	0	997
12	33	21
1009	33	1018
1%	100%	2%
1041	33	1050
1061	33	1070

FD_001 = 2023 AM Peak Base (08:15 - 09:15) = Surveyed Traffic
 FD_003 = 2027 Opening Year, AM
 FD_005 = Development Flows, AM
 FD_007 = 2027 + Development Flows, AM
 % Impact on Each Arm
 FD_009 = 2032 Factored Base + Dev Flows = +5yrs, AM
 FD_011 = 2042 Factored Base + 15yrs + Dev Flows, AM

FD_012 = 2042 Factored Base + 15yrs + Dev Flows, PM

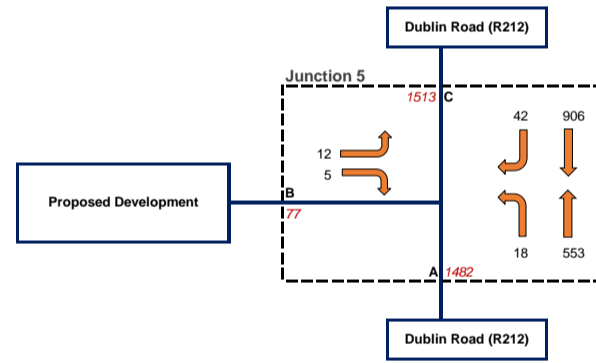

Junction 5		
Proposed Dev Entrance		
A	B	C
1321	0	1321
1386	0	1386
23	77	54
1409	77	1440
2%	100%	4%
1409	77	1440
1482	77	1513

FD_002 = 2023 PM Peak Base (17:00 - 18:00) = Surveyed Traffic
 FD_004 = 2027 Opening Year, PM
 FD_006 = Development Flows, PM
 FD_008 = 2027 + Development Flows, PM
 % Impact on Each Arm
 FD_010 = 2032 Factored Base + Dev Flows = +5yrs, PM
 FD_012 = 2042 Factored Base + 15yrs + Dev Flows, PM